

**ACDC**<sup>TM</sup>  
—  **DYNAMICS**  
[www.acdc.co.za](http://www.acdc.co.za)



*The Leading Supplier of Industrial & Commercial*  
**LIGHTING SOLUTIONS**  
*Truely unique & advanced lighting solutions for all applications*

**T H I N K   E L E C T R I C A L**

## LIGHTING INDEX

ITEMS	Page				
<b>Lamps</b>	<b>1-27</b>	Induction Highbays	41	Brick Lights	124-125
LED T8 Tubes	1-3	HID Highbays	42	Foot Lights	126
LED T5 Tubes	3	Empty Highbays	42	Wall Recessed	127
LED GU10/MR16	4	T-Bays	43	Wall Surface	128
LED Filament	5	Linear Highbays	44	Bulkheads	129-134
LED A60	6	LED Highbays/Lowbays	45	Wall Lights	134-138
LED High Power	6	LED Gas Station Lights	46	Up/Down Lights	139-140
LED Candle	7	LED Parking Bay Lights	46	<b>Indoor</b>	<b>140-147</b>
LED Golf Ball	7	HID Lowbays	46	Up/Down Lights	140-141
LED Reflector Lamp	8	LED Streetlights	47-49	Wall Lights	141
LED E27 Downlight	8	HID Streetlights	49-50	Ceiling Lights	142-144
LED Compact	8	PL Street Lights	50	Ceiling Spot Lights	144-146
LED PAR	9-10	Empty Street Light	50	Picture Lights	146-147
LED Pygmy	10	Induction Street Lights	50	Linear Ceiling	147
LED 2U/3U/4U	11	LED Bulkheads	51	<b>Accessories</b>	<b>148-162</b>
LED Corn	11	Induction Bulkheads	51	Decorative Cord	148
LED RX7s	11	PL Bulkheads	51	Lamp Holders	148-151
LED PL	11	HID Bulkheads	52	Switches	149
LED G9/JC/G4/G12	12	Empty Bulkheads	52	LED Surge Protection	149
LED High Power Corn	12	LED Vandal Proof	52	Sensors	151-155
LED High Power T-Lamps	13	Vapour Proof	53-57	Dimmers	156
LED High Power Lamps	13	<b>Commercial</b>	<b>57-112</b>	Timers	156
LED Dimmable T-Lamps	14	Linear Lights	57-61	Constant Current Drivers	157-158
LED High Power U-Lamps	14	Office Lights	61-62	Dimmable Electronic Transformers	158
LED High Power	14	Open Channel	62-63	Transformers	158
LED AR111	15	LED Panel	64-65	Electronic Ballasts	159-161
LED PLL	15	Recessed Office	65-66	Magnetic Ballasts	161-162
LED Retrofit	15	Surface Office	67	Ignitors	161-162
LED High Power Modules	16	Downlights	68-75, 78-81	<b>Emergency</b>	<b>163-168</b>
LED Smart Lamps	16-17	Downlight Fittings	76-78	Emergency Kits	163
LED Décor Lamps	18	Spot Lights	82	Emergency Lights	164-168
Carbon Filament	19	Display Spot Lights	82	<b>Specialized</b>	<b>169-172</b>
Pygmy- Incandescent	19	Track Lights	83-84	Chicken Farming Lights	169
Standard Filament	19	Cabinet Lights	84-88	Plant Grow Lights	169-170
Fluorescent PL / 2D	19-20	DC Lights	89-90	LED UVC Lights	171
Fluorescent Tubes	20	Strip Lights	91-93	Parking Bay Lights	172
Fluorescent T8-T5 Conversion	21	Strip Controllers	94-95	<b>Portable</b>	<b>172-176</b>
Infrared PAR38	21	Strip Light Kits	96-98	Work Lights	172-173
UV Lamps	21	Hexagon LED Tiles	96	Torches	174
High Power CFL	21	Profiles	99-101	Head Lamps	175
Compact Fluorescent	22-24	Specialized Strips	102	Bicycle Lights	175
Halogen RX7s	24	Strip Connectors	102	Camping Lights	176
Halogen G4/JC/JD	25	Rigid Strip Lights	103-105	<b>Ornamental</b>	<b>176-177</b>
Incandescent Lamps	25	230V Strips Lights	105	Music Lights	176
Dichroic Lamp	25	LED Modules	105-106	Colour Changing	176-177
Induction Lamps	39	Neon Flex	107-108	<b>Festive</b>	<b>177-187</b>
HID	26-27	Smart Control	109	Belt Lights	177
<b>Industrial</b>	<b>28-55</b>	DMX Control	110	Rope Lights	178-181
LED Floodlights	28-33	Constant Voltage Drivers	110-112	Projectors	180
LED Work Lights	33	<b>Outdoor</b>	<b>113-140</b>	Curtain Lights	182-183
Portable Floodlights	33-34	Floor Lights	113	3D Motif	184-185
Billboard Floodlights	34-35	Wall Lights	113	Mini Rope Motif	185-187
LED Wall Washers	35	Deck Lights	114	<b>Display</b>	<b>188</b>
Induction Floodlights	35	Inground Lights	115	Test Case	188
CFL Floodlights	36	Spike Lights	116-117	Shelf Light	188
HID Floodlights	36-37	Bollards	118-119	Shower Heads	188
Empty Floodlights	37	Post Tops	119-120	<b>Stage</b>	<b>189-190</b>
HID Highmast Floodlights	37	Poles	121	PAR Cans	189
HID Stadium Floodlights	37	Spot Lights	121	Search Lights	189
LED Highbays	38-40	Underwater Lights	121-122	Laser Lights	190
		Pool Lights	122-124		

## LED T8 TUBULAR LIGHTING

- WW - 2700K
- CW - 4200K
- DL - 6000K

**2 Year Warranty!**



**T8 LED Tubes - Glass** - Supply Voltage: 230-240VAC | Non-Dimmable | CRI: 70 | Diameter: 26.3mm | Power factor: >0.95 | Efficiency: 90lm/W | Single End Wired | Can operate in temperatures between -10°C to +45°C

Code FROSTED	Code CLEAR	Length	Lumen	Power	*Add colour to code
LEDT8-A2FR-*	LEDT8-A2C-*	600mm (2FT)	700-800lm	9W	WW / CW / DL / ●R / ●GN / ●BL / ●Y
LEDT8-A3FR-*	LEDT8-A3C-*	900mm (3FT)	860-950lm	13W	
LEDT8-A4FR-*	LEDT8-A4C-*	1200mm (4FT)	1480-1600lm	18W	
LEDT8-A5FR-*	LEDT8-A5C-*	1500mm (5FT)	1750-1900lm	22W	
LEDT8-A8FR-*	-	2365mm (8FT)	3200lm	36W	

**Note:** Colour only available in frosted tubes.

\* For DC add to code: 12VDC, 24VDC, 48VDC. **Note:** DC Tubes available in frosted and clear

- CW - 4200K
- DL - 6000K

**3 Year Warranty!**



**T8 LED Tubes - PC** - Supply Voltage: 85-265VAC | Non-Dimmable | CRI: 80 | Diameter: 26.3mm | PF 0.95 | Efficiency: 90lm/W | Single End Wired | With MOV Surge Protection | 270° View Angle | Can operate in temperatures between -10°C to +45°C

Code	Length	Lumen	Power	*Add colour to code
LEDT8-A2FR-*/PC	600mm	800lm	9W	CW / DL
LEDT8-A4FR-*/PC	1200mm	1600lm	18W	CW / DL
LEDT8-A5FR-*/PC	1500mm	1900lm	22W	CW / DL

- CW - 4200K
- DL - 6000K

**5 Year Warranty!**



**T8 LED Tubes - PC / Aluminium** - Supply Voltage: 85-265VAC Wide Range | Non-Dimmable | CRI: 80 | Diameter: 26.3mm | Power Factor: >0.95 | Efficiency: 160lm/W | Single End Wired | Flicker Free | Can operate in temperatures between -20°C to +45°C

Code FROSTED	Length	Lumen	Power	*Add colour to code
T8-5Y-A2FR-*	600mm (2FT)	1440lm	9W	CW / DL
T8-5Y-A3FR-*	900mm (3FT)	2080lm	13W	CW / DL
T8-5Y-A4FR-*	1200mm (4FT)	2880lm	18W	CW / DL
T8-5Y-A5FR-*	1500mm (5FT)	3520lm	22W	CW / DL

- CW - 4200K
- DL - 6000K



**T8 LED Tubes - Dimmable** - Supply Voltage: 220-240VAC | CRI: 80 | Diameter: 26.3mm | Efficiency: 90lm/W | Power factor: >0.95 | Glass Tube | TRIAC Dimming

Code	Length	Lumen	Power	*Add colour to code
DIMT8-A2FR-*	600mm	800lm	9W	CW / DL
DIMT8-A4FR-*	1200mm	1600lm	18W	CW / DL
DIMT8-A5FR-*	1500mm	1900lm	22W	CW / DL

- CW - 4200K
- DL - 6000K



**T8 LED Tubes - Single Pin** - Supply Voltage: 230VAC | Diameter: 26mm | Glass | Power factor: >0.95

Code Frosted	Length	Lumens	Power	*Add colour to code
LEDT8SP-A4FR-*	1200mm (4ft)	1710lm	18W	CW / DL
LEDT8SP-A5FR-*	1500mm (5ft)	2090lm	22W	CW / DL
LEDT8SP-A8FR-*	2365mm (8ft)	3420lm	36W	CW / DL

# LED T8 TUBULAR LIGHTING

- CW - 4200K
- DL - 6000K



Could be used inside waterproof fittings or behind a diffuser

- CW - 4200K
- DL - 6000K



**NEW**

- CW - 4200K
- DL - 6000K

**2 Year Warranty!**



**NEW**



- CW - 4200K
- DL - 6000K

**3 Year Warranty!**



**NEW**

**T8 Microwave Motion Sensing SMD LED Tubes** - 85-265VAC | Intelligent microwave motion sensing technology | Motion detection angle: 180° | Motion detection range: ≤10m

Code	Length	Lumen	Power	Replaces T8 Lamp	*Add colour to code
LEDT8MW-A2FR-*	600mm	800-850lm	9W	18W (2FT)	CW / DL
LEDT8MW-A3FR-*	900mm	1450-1500lm	15W	30W (3FT)	CW / DL
LEDT8MW-A4FR-*	1200mm	1750-1850lm	18W	36W (4FT)	CW / DL
LEDT8MW-A5FR-*	1500mm	2100-2200lm	22W	58W (5FT)	CW / DL

**T8 PIR Motion Sensing SMD LED Tubes** - 85-265VAC | PIR detection angle: 120° | PIR Range: 5-7m | Turn off delay: 30 seconds | Switch on time: 0.5s from detection

Code	Length	Lumen	Power	Replaces T8 lamp	*Add colour to code
LEDT8S-A2FR-*	600mm	800-850lm	9W	18W (2FT)	WW / CW / DL
LEDT8S-A3FR-*	900mm	1100-1200lm	13W	30W (3FT)	WW / CW / DL
LEDT8S-A4FR-*	1200mm	1750-1850lm	19W	36W (4FT)	WW / CW / DL
LEDT8S-A5FR-*	1500mm	2100-2200lm	22W	58W (5FT)	WW / CW / DL

**T8 Waterproof LED Tubes - PC IP65** - 180 - 265VAC | Non-Dimmable | CRI > 80 | Diameter 26mm | Power Factor 0.95 | Efficiency: 100lm/W | Operating Temp -10° to +45°C | Waterproof PC End Caps | Connection wire length 500mm

Code	Length	Lumen	Power	*Add colour to code
XGY-T8-A2FR-*	600mm	850lm	9W	CW / DL
XGY-T8-A3FR-*	900mm	1500lm	15W	CW / DL
XGY-T8-A4FR-*	1200mm	3600lm	18W	CW / DL
XGY-T8-A5FR-*	1500mm	5800lm	22W	CW / DL

**T8 Food Display (Butcher) SMD LED Tubes** - 85-265VAC | These lamps are specially designed to ensure that food is displayed in an appetizing light. The light generated by the lamp makes meat, bread and other food look fresh and appealing. Also because LED lamps have no glass in their construction they are especially suitable for the food industry.

Code	Length	Power	Replaces T8 Lamp
LEDT8BL-A2FR	600mm	9W	18W (2FT)
LEDT8BL-A3FR	900mm	15W	30W (3FT)
LEDT8BL-A4FR	1200mm	18W	36W (4FT)
LEDT8BL-A5FR	1500mm	22W	58W (5FT)

See page 99 for shelf tag with butcher strip light

**T8 Medical LED Tubes IP65** - 85-265VAC | With COI (Cyanosis Observation Index) < 2.5, Lantis LED Tubes are suitable for medical lighting application within hospitals in operating theatres, patient treatment rooms, consulting rooms, accident / trauma emergency areas that require close colour rendition of skin | RA > 90

Code	Length	Lumen	Power	Replaces T8 lamp	*Add colour to code
LTS-T8-A2FR-*	600mm	1000 - 1100lm	10W	18W (2FT)	CW / DL
LTS-T8-A4FR-*	1200mm	1500 - 1600lm	16W	36W (4FT)	CW / DL
LTS-T8-A5FR-*	1500mm	2200 - 2500lm	23W	58W (5FT)	CW / DL

**T8 UVC LED Tubes** - Input Voltage: 85-265VAC | 120° Beam Angle | Wavelength Range 270-280nm | Peak Wavelength 275nm | Radiant Flux max 5mW | Ceramic Substrate and Quartz Glass | Highly effective against inactivating and destroying the DNA of micro organisms found in mould, germs, bacteria and viruses.

Code	Wattage	Spectrum	Size (mm)
LEDT8-UVC-A2	9W	UVC	600 (2ft)
LEDT8-UVC-A4	15W	UVC	1200 (4ft)
LEDT8-UVC-A5	20W	UVC	1500 (5ft)

## LED T8 TUBULAR LIGHTING



**T8 LED for Walk-In Freezers** - 220-240VAC | Significant energy & maintenance cost savings | Improved illumination of products | Reduced heat | Environmentally-friendly - no mercury | No glass breakage | No UV light | Aluminium Backing & PC Diffuser

Code	Length	Power
LETT8-26W	1700mm	26W



**T8 Plant Growing SMD LED Tubes** - 85-265VAC | 75% Blue, 25% Red | Plant grow lamps have LED's that produce light in Blue (450nm) and Red (660nm) wavelengths that are ideal for promoting photo-biological processes in plants. These lamps can be used wherever plants do not receive enough natural light or in agricultural applications. For more see page 167-168

Code	Length	Power	Replaces T8 Lamp
LEDT8PG-A2FR	600mm	9W	18W (2FT)
LEDT8PG-A3FR	900mm	15W	30W (3FT)
LEDT8PG-A4FR	1200mm	18W	36W (4FT)
LEDT8PG-A5FR	1500mm	22W	58W (5FT)

- CW - 4200K
- DL - 6000K



**T8 LED Tubes - Maintained Emergency** - With Internal Battery | Supply Voltage: 230VAC | Maintained emergency lighting luminaires are built to be active continuously in every day life, and through the event of a power cut, irrespective if switch is on or off | Emergency Back-Up Time: 1 Hour @ 300lm

Code	Length	Lumen	Power	*Add colour to code
EMG-M-LEDT8-A2FR-*	600mm	800lm	9W	CW / DL
EMG-M-LEDT8-A4FR-*	1200mm	1600lm	18W	CW / DL
EMG-M-LEDT8-A5FR-*	1500mm	1900lm	22W	CW / DL

- CW - 4200K
- DL - 6000K



**T8 LED Tubes - Non-Maintained Emergency** - With Internal Battery | Supply Voltage: 230VAC | Emergency Back-Up Time: 1 Hour @ 300lm | **Emergency only works when switch is on and mains fail** | Tube to be wired independantly

Code	Length	Lumen	Power	*Add colour to code
EMG-LEDT8-A2FR-*	600mm	800lm	9W	CW / DL
EMG-LEDT8-A4FR-*	1200mm	1600lm	18W	CW / DL
EMG-LEDT8-A5FR-*	1500mm	1900lm	22W	CW / DL

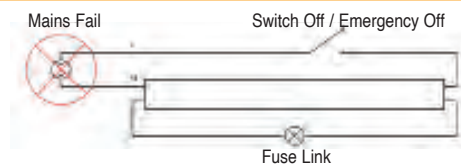
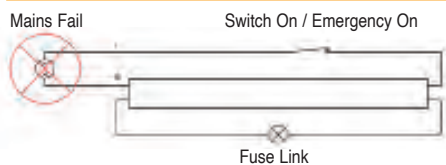

### Accessories for T8 Tubes



Code	Description
EL-FL	Fuse Link to replace Starter
LEDT8-CLIP	CLIP for mounting of Tube in Lightbox
LEDT8-LLH	Loose Lamp Holder
LEDT8-CONL	1.5m T8 Connector Lead

## LED T5 TUBULAR LIGHTING

- CW - 4200K
- DL - 6000K



**LED T5 Tubes** - 220-240VAC | Diameter: 19mm | Power factor: >0.95 | Efficiency: 80lm/W | Material: Aluminium + PC

Frosted Code	Length	Wattage	Lumen	*Add colour to code
LEDT5-A2FR-*	550mm (2FT)	7W	580lm	CW / DL
LEDT5-A3FR-*	900mm (3FT)	14W	1120lm	CW / DL
LEDT5-A4FR-*	1150mm (4FT)	16W	1280lm	CW / DL
LEDT5-A5FR-*	1450mm (5FT)	20W	1600lm	CW / DL

## LED GU10 - 230VAC

### Non-Dimmable

<ul style="list-style-type: none"> <li>○ WW - 2700K</li> <li>○ CW - 4200K</li> <li>○ DL - 6000K</li> </ul>							
	Single	5 Pack	Single	5 Pack	Single	Single	5 Year Warranty
<b>Code</b>	<b>SMD-GU10-3W-*</b>	<b>LED-GU10-3W-*/5</b>	<b>SMD-GU10-6W-*</b>	<b>LED-GU10-6W-*/5</b>	<b>HS-GU10-5W-*</b>	<b>KL-GU10-7W-*</b>	<b>HS-GU10-5W-*/5Y</b>
Wattage	3W	3W	6W	6W	5W	7W	5W
Lumens	240lm	250lm	480lm	480lm	450lm	500lm	350lm
Beam Angle	120°	120°	120°	120°	45°	38°	48°
*Add Colour to Code	WW / CW / DL / ●R / ●GN / ●BL / ●Y	WW / CW / DL	WW / CW / DL	WW / CW / DL	WW / CW	WW / CW	WW / CW / DL

### Non-Dimmable

### Dimmable

### 2-3hrs Emergency

<ul style="list-style-type: none"> <li>○ WW - 2700K</li> <li>○ CW - 4200K</li> <li>○ DL - 6000K</li> </ul>							
						5 Year Warranty	
<b>Code</b>	<b>GU10-3528-60-*</b>	<b>DIM-MS-GU10-5W-*</b>	<b>DIM-GU10-5W-*</b>	<b>DIM-KL-GU10-7W-*</b>	<b>DIM-GU10-5W-*/5Y</b>	<b>EMG-SMD-GU10-3W-*</b>	<b>EMG-SMD-GU10-5W-*</b>
Wattage	3W	5W	5W	7W	5W	3W	5W
Lumens	380lm	380lm	450lm	560lm	350lm	190lm Normal 85lm Emergency	550lm Normal 120lm Emergency
Beam Angle	120°	120°	38°	38°	48°	120°	120°
*Add Colour to Code	WW / CW / DL	WW / CW / DL	WW / CW	WW / CW / DL	WW / CW / DL	WW / CW / DL	WW / CW / DL

## LED MR16 - 12V

### Non-Dimmable

<ul style="list-style-type: none"> <li>○ WW - 2700K</li> <li>○ CW - 4200K</li> <li>○ DL - 6000K</li> </ul>							
<b>Code</b>	<b>SMD-MR16-3W-*</b>	<b>SMD-MR16-6W-*</b>	<b>HS-MR16-5W-*</b>	<b>KL-MR16-7W-*</b>	<b>MR16-3528-60-*</b>	<b>HS-MR16-1X3W-*</b>	<b>HS-MR16-5W-*/5Y</b>
Wattage	3W	6W	5W	7W	3W	3W	5W
Lumens	250lm	480lm	350lm	500lm	380lm	200lm	350lm
Beam Angle	120°	120°	45°	38°	120°	60°	48°
*Add Colour to Code	WW / CW / DL	WW / CW / DL	WW / CW	WW / CW	WW / CW / DL	WW / CW / ●R / ●GN / ●BL / ●Y	WW / CW / DL

### Non-Dimmable

### Dimmable

<ul style="list-style-type: none"> <li>○ WW - 2700K</li> <li>○ CW - 4200K</li> <li>○ DL - 6000K</li> </ul>							
	230VAC	230VAC	12V	230VAC	12V	12V	12V
<b>Code</b>	<b>HS-MR16-1X3W-*/230</b>	<b>HS-MR16-3X1W-*/230</b>	<b>DIM-MR16-35-60-*</b>	<b>DIM-MR16-35-60-*/230</b>	<b>DIM-MS-MR16-5W-*</b>	<b>DIM-MR16-5W-*</b>	<b>DIM-KL-MR16-7W-*</b>
Wattage	3W (1 x 3W)	3W (3 x 1W)	4W	4W	5W	5W	7W
Lumens	240lm	200lm	380lm	380lm	380lm	450lm	670lm
Beam Angle	28°	60°	120°	120°	120°	38°	38°
*Add Colour to Code	WW / CW	WW / CW	CW / DL	WW / CW / DL	WW / CW / DL	WW	WW / CW

# LED IMITATION FILAMENT LAMP



LED Ball Lamp		• Supply Voltage: 220-240VAC			• CRI: 80	
Code	Code (Dimmable)	LED Power	Base	Lumen	Beam	Colour
B60-4W-E27-*	-	4W	E27	450lm	360°	WW / CW
B60-4W-B22-*	-	4W	B22	450lm	360°	WW / CW
B60-6W-E14-*	-	6W	E14	700lm	360°	WW / CW
B60-6W-E27-*	-	6W	E27	700lm	360°	WW / CW
B60-6W-B22-*	-	6W	B22	700lm	360°	WW / CW
LED Candle Lamp		• Supply Voltage: 220-240VAC			• CRI: 80	
C35-2W-E14-*	-	2W	E14	225lm	360°	WW / CW
C35-2W-E27-*	-	2W	E27	225lm	360°	WW / CW
C35-2W-B22-*	-	2W	B22	225lm	360°	WW / CW
C35-4W-E14-*	DIM-C35-4W-E14-CW	4W	E14	350lm	360°	WW / CW
C35-4W-E27-*	-	4W	E27	450lm	360°	WW / CW
C35-4W-B22-*	-	4W	B22	450lm	360°	WW / CW
LED Flame Candle Lamp		• Supply Voltage: 220-240VAC			• CRI: 80	
C35L-2W-E14-*	DIM-C35L-2W-E14-CW	2W	E14	245lm	360°	WW / CW
C35L-2W-E27-*	-	2W	E27	245lm	360°	WW / CW
C35L-2W-B22-*	-	2W	B22	245lm	360°	WW / CW
LED Golf Ball Lamp		• Supply Voltage: 220-240VAC			• CRI: 80	
G45-2W-E14-*	-	2W	E14	245lm	360°	WW / CW
G45-2W-E27-*	-	2W	E27	245lm	360°	WW / CW
G45-2W-B22-*	-	2W	B22	245lm	360°	WW / CW
LED Reflective Lamp		• Supply Voltage: 220-240VAC			• CRI: 80	
R50-2W-E14-*	-	2W	E14	245lm	120°	WW / CW
R63-4W-E27-*	-	4W	E27	450lm	120°	WW / CW
R63-4W-B22-*	-	4W	B22	450lm	120°	WW / CW
R80-4W-E27-*	-	4W	E27	450lm	120°	WW / CW
R80-4W-B22-*	-	4W	B22	450lm	120°	WW / CW
LED Ball Lamp		• Supply Voltage: 220-240VAC			• CRI: 80	
G125-4W-E27-*	-	4W	E27	450lm	360°	WW / CW
G125-4W-B22-*	-	4W	B22	450lm	360°	WW / CW
G125-6W-E27-*	-	6W	E27	750lm	360°	WW / CW
G125-6W-B22-*	-	6W	B22	750lm	360°	WW / CW
LED Pear Shape Lamp		• Supply Voltage: 220-240VAC			• CRI: 80	
ST64-4W-E27-*	-	4W	E27	450lm	360°	WW / CW
ST64-4W-B22-*	-	4W	B22	450lm	360°	WW / CW
ST64-6W-E27-*	-	6W	E27	700lm	360°	WW / CW
ST64-6W-B22-*	-	6W	B22	700lm	360°	WW / CW

\*Add colour to code: ○ CW (Cool White) 4000-4200K or ○ WW (Warm White) 2700-3000K  
 360° lighting to directly replace traditional incandescent lamp 20W, 40W & 60W. Special elongated LED encapsulation technique allows LED to give the same effect as an incandescent tungsten filament lamp.

## NEW A60 LED FILAMENT PLANT GROW LAMP - E27



Input Voltage: 180 - 265VAC | Dimensions: Ø60 x 108mm | Full Colour Spectrum for general use | Ideal for greenhouse glass or plastic, Planting factory, Hydroponic shelves, Home Planting.

Code	Wattage	Colour Spectrum	PPF (400-700nm)	PAR Watt (/W) (400-700nm)	EFF (PPF) (400-700nm)
XGY-A60-8-E27	8W	Full Spectrum	>12 μ mol	0.3 - 0.5mW	>1.5 μ mol/s/W

## NEW LED LAMPS (TO REPLACE MERCURY BLENDED LAMPS)



Supply Voltage: 90-265VAC

Code	Wattage	Base	Lumens	Size (mm)	Replace	Colour
HLT-E40-15W-*	15W	E40	2200lm	Ø46 x 195	-	CW / DL
HLE-E40-15W-*	15W	E40	1800lm	Ø90 x 225	-	CW / DL
HLE-E40-20W-*	20W	E40	2800lm	Ø90 x 225	80W	CW / DL
HLE-E40-30W-*	30W	E40	3800lm	Ø90 x 225	160W	CW / DL
HLE-E40-40W-*	40W	E40	5800lm	Ø118 x 290	250W	CW / DL

\*Add colour to code: ○ CW (Cool White) 4000-4200K or ○ DL (Day Light) 6000K

## LED LAMPS

E27 & B22	A60 B22	A60 E27	A60 B22	A60 E27	Code	Wattage	Base	Lumen	Beam Angle	*Add Colour to Code
<b>Non-Dimmable</b>										
Supply Volts: 230VAC										
<ul style="list-style-type: none"> <li>○ WW - 2700K</li> <li>○ CW - 4200K</li> <li>○ DL - 6000K</li> </ul>										
5W, 7W, 9W										
15W										
170-260VAC										
25W										
35W										
50W										
70W-100W										
<b>E27 &amp; B22</b>										
<b>Dimmable</b>										
Supply Volts: 230VAC										
E27										
B22										
<b>LED A60 Lamp - Various Sensing Options</b>										
<b>Non-Dimmable</b>										
Supply Volts: 220-240VAC										
DL										
A60-LSM										
HS-E27-PIR										
Day/Night Sensor										
Day/Night & Motion Sensor										
Motion Sensor										
<b>DC LED Lamps - Cool White</b>										
<b>Non-Dimmable</b>										
12VDC / 24VDC										
L2403										
L2405										
L2407										

\* Add Voltage to Code: 12VDC, \* 24VDC

	Value Packs - 230VAC		Colour lamps - 230VAC		LED UV A60	
<ul style="list-style-type: none"> <li>○ WW - 2700K</li> <li>○ CW - 4200K</li> <li>○ DL - 6000K</li> </ul>						
<b>Code</b>	LED-A60-5W-*/2	LED-A60-7W-*/2	E27-C60LED-*	B22-C60LED-*	LEDE27-M	UV-E27-3W
<b>Wattage</b>	5W	7W	3W	3W	1W	3W
<b>Base</b>	*E27 / *B22	*E27 / *B22	E27	B22	E27	E27
<b>Lumens</b>	450lm	540lm	-	-	-	-
<b>Beam Angle</b>	270°	270°	270°	270°	270°	200°
<b>*Add colour to code</b>	WW / CW / DL	WW / CW / DL	WW / CW / ●R / ●GN / ●BL / ●Y	●R / ●GN / ●BL / ●Y	Auto Colour Changing	UV

	Mosquito Repellant - 230VAC	Insect Killing Lamps	Boiler Inspection - 32VAC
<ul style="list-style-type: none"> <li>○ WW - 2700K</li> <li>○ CW - 4200K</li> <li>○ DL - 6000K</li> </ul>			
<b>Code</b>	MR-LED-A60-*/5W	RW-MKL-15W	SP-DYT90
<b>Wattage</b>	5W	15W	7W
<b>Base</b>	*E27 / *B22	E27	Hook
<b>Lumens</b>	300lm	400lm	200lm
<b>Beam Angle</b>	270°	275°	270°
<b>Colour Temperature</b>	Mosquito Repellant Yellow	CW (6000K)	CW (4200K)



## LED CANDLE LAMPS - 230VAC

### Non-Dimmable

- WW - 2700K
- CW - 4200K

<b>Code E14</b>	T-LEDB35R-E14-*	-	-	T-LEDC35L-E14-*	SP-E14-CLH37-*	T-LEDB35R-E14-*/3
<b>Code E27</b>	-	T-LEDB35R-E27-*	-	-	-	-
<b>Code B22</b>	-	-	T-LEDB35R-B22-*	-	-	-
Wattage	3W	3W	3W	3W	1.6W	3W
Base	E14	E27	B22	E14	E14	E14 / E27 / B22
Lumens	245lm	245lm	245lm	245lm	-	245lm
Beam Angle	180°	180°	180°	180°	180°	180°
*Add colour to code	WW / CW	WW / CW	WW / CW	WW / CW	WW / CW / ●R / ●GN / ●BL / ●Y	WW / CW

### Dimmable

- WW - 2700K
- CW - 4200K

<b>Code</b>	LEDC212-*	LEDC35E-E27-*	LEDC35E-B22-*	LEDC35E-B15-*	LEDC35L-E14-*
Wattage	5W	5W	5W	5W	5W
Base	E14	E27	B22	B15D	E14
Lumens	400lm	400lm	400lm	400lm	400lm
Beam Angle	270°	270°	270°	270°	270°
*Add colour to code	WW / CW	WW / CW	WW / CW	WW	WW / CW

## LED GOLF BALL LAMPS - 230VAC

### Non-Dimmable

- WW - 2700K
- CW - 4200K

<b>Code</b>	T-LEDG50R-E14-*	T-LEDG50R-E27-*	T-LEDG50R-B22-*	LEDA35E-*
Wattage	3W	3W	3W	3W
Base	E14	E27	B22	E27
Lumens	245lm	245lm	245lm	200lm
Beam Angle	180°	180°	180°	270°
*Add colour to code	WW / CW	WW / CW	WW / CW	WW / CW

### Colour Lamps

### Value Packs

- WW - 2700K
- CW - 4200K

<b>Code</b>	LE45-0.6-E27-*/2	LE45-0.6-E27-*/2	LE45-0.6-B22-**	LE45-0.6-B22-**	T-LEDG50R-E27-*/3	T-LEDG50R-B22-*/3
Wattage	1W	1W	1W	1W	3W	3W
Base	E27	E27	B22	B22	E27	B22
Lumens	-	-	-	-	245lm	245lm
Beam Angle	270°	270°	270°	270°	180°	180°
*Add colour to code	WW / CW / ●R / ●GN / ●BL / ●Y	WW / CW / ●R / ●GN / ●BL / ●Y / ●O (Orange) / ●●●●●O	WW / CW / ●R / ●GN / ●BL / ●Y / ●O (Orange) / ●●●●●O	WW / CW / ●R / ●GN / ●BL / ●Y / ●O (Orange) / ●●●●●O	WW / CW	WW / CW

\*Add pack size to code: /2 (2 Pack), /5 (5 Pack - only mixed colours)

## LED LAMPS - 230VAC

### Non-Dimmable Reflector Type

- WW - 2700K
- CW - 4200K

<td> <td> </td></td>	<td> </td>					
Code	LED-R39-3W-*	LED-R50-3W-*	LED-R50-6W-*	LED-R63-4.5W-*	LED-R63-8W-*	LED-R80-10W-*
Wattage	3W	3W	6W	4.5W	8W	10W
Base	E14	E14	E14	E27	E27	E27
Lumens	240lm	240lm	540lm	360lm	720lm	850lm
Beam Angle	160°	160°	160°	160°	160°	160°
*Add colour to code	WW / CW	WW / CW	WW / CW	WW / CW	WW / CW	WW / CW

### Dimmable Reflector Type

- WW - 2700K
- CW - 4200K

<td> </td>				
Code	DIM-R39-3W-*	DIM-R50-6W-*	DIM-R63-8W-*	DIM-R80-10W-*
Wattage	3W	6W	8W	10W
Base	E14	E14	E27	E27
Lumens	240lm	540lm	720lm	850lm
Beam Angle	160°	160°	160°	160°
*Add colour to code	WW / CW	WW / CW	WW / CW	WW / CW

### Non-Dimmable G95 (Ø95mm)

### Non-Dimmable G125 (Ø125mm)

- WW - 2700K
- CW - 4200K

<td> </td>				
Code	G95-E27-12W-*	G95-E27-15W-*	G120-E27-15W-*	G120-E27-18W-*
Wattage	12W	15W	15W	18W
Base	E27	E27	E27	E27
Lumens	960lm	1200lm	1200lm	1600lm
Beam Angle	270°	270°	270°	270°
*Add colour to code	WW / CW	WW / CW	WW / CW	WW / CW

### Non - Dimmable JDR Lamps

### Dimmable JDR

- WW - 2700K
- CW - 4200K

<td> <td></td> </td>	<td></td>					
Code	T-LEDJDRR-*	HS-JDR-1X3W-*	HS-JDR-3X1W-*	HS-JDR-3X2W-*	HS-JDR-5W-*	DIM-E27
Wattage	4W	3W	3W	6W	5W	6W
Base	E27	E27	E27	E27	E27	E27
Lumens	250-280lm	200lm	240lm	340-360lm	330-350lm	380lm
Beam Angle	280°	60°	38°	38°	60°	38°
*Add colour to code	WW / CW	WW / CW	WW / CW / ●R / ●GN / ●BL / ●Y	WW / CW	WW / CW	WW / CW

## LED COMPACT LAMPS

- WW - 2700K
- CW - 4200K

Code	LP-T48-2-0.6W	LP-T48-2-2W	LP-T48-2-4W	LP-T45-4-0.6W	LP-T45-4-1.4W
Wattage	0.6W	2W	4W	0.6W	1.4W
Base	E27	E27	E27	E27	E27
Lumens	45lm	150lm	300lm	45lm	105lm
Beam Angle	180°	180°	180°	180°	180°
*Add colour to code	CW	CW	CW	CW	CW

## PAR LED LAMPS

NEW

- WW - 2700K
- CW - 4000K



PAR - Supply Voltage 220-240VAC | IP65

Code	Wattage	Lumens	Base	Beam Angle	*Add Colour to Code
PAR20-LED-9W-*	9W	720lm	E27	60°	WW / CW
<b>PAR30 Non-Dimmable</b>					
PAR30-LED-13W-*	13W	1000lm	E27	60°	WW / CW
<b>PAR38 Non-Dimmable</b>					
PAR38-LED-17W-*	17W	1360lm	E27	60°	WW / CW
PAR38-LED-22W-*	22W	1800lm	E27	60°	WW / CW

NEW



PAR LED Colour - Supply Voltage 220-240VAC | IP65

PAR20-4407-*	6W	450lm	E27	42°	●R / ●G / ●B / ●Y
<b>PAR30 Colour</b>					
PAR30-4206-*	10W	800lm	E27	42°	●R / ●G / ●B / ●Y
<b>PAR38 Colour</b>					
PAR38-4306-*	15W	1300lm	E27	30°	●R / ●G / ●B / ●Y

- WW - 2700K
- CW - 4000K



PAR Lamps - Supply Voltage 85-260VAC | IP65 | Same shape as original PAR

LEDPAR20-*	5W	425lm	E27	60°	WW / CW / ●R / ●GN / ●BL / ●Y
LEDPAR30-*	9W	765lm	E27	60°	●BL / ●Y
LEDPAR38-12W-*	12W	1170lm	E27	60°	●●●M (Colour Changing)

- WW - 2700K
- CW - 4000K



PAR 38 Anti Glare - Supply Voltage 220-240VAC

KL-PAR38-18W-*	18W	1200-1300lm	E27	40°	WW / CW
----------------	-----	-------------	-----	-----	---------

PAR 38 Colour Lamp - Supply Voltage 220-240VAC

HS-PAR38-18W	18W	1200lm	E27	60°	●R / ●BL / ●Y
--------------	-----	--------	-----	-----	---------------

### Dimmable PAR Lamps - 230VAC

- WW - 2700K
- CW - 4000K



PAR 20 - Supply Voltage 220-240VAC | IP65

Lamp Code	Wattage	Lumens	Base	Beam Angle	*Add Colour to Code
DIM-PAR20-10W-*	10W	830-890lm	E27	60°	WW / CW

PAR 30 - Supply Voltage 220-240VAC | IP65

DIM-PAR30-12W-*	12W	930-1000lm	E27	120°	WW / CW
-----------------	-----	------------	-----	------	---------

PAR 38 Narrow Angle - Supply Voltage 220-240VAC | IP65

LCM8106-60DIM-*	18W	1440lm	E27	60°	WW / CW
-----------------	-----	--------	-----	-----	---------

PAR 38 Wide Angle - Supply Voltage 220-240VAC | IP65

LCM8106-160DIM-*	18W	1440lm	E27	160°	WW / CW
------------------	-----	--------	-----	------	---------

LR20-10W01



PAR 20 VARI FOCAL - Supply Voltage 110-240VAC | Colour Temperature 5000K | Variable Beam Angle

Code	Base	LED Qty/W	Total LED Watts	Lumen for CW	Lumen for WW	Beam Angle	Colour Temperature
LR20-04W01	E27	1 x 4W	4W	90-160lm	90-160lm	15-40°	5000K
LR20-10W01	E27	1 x 10W	10W	360-520lm	360-520lm	15-40°	5000K

#### Accessories

Code	Description
LR30-LHA-B22	Interchangeable adaptor from E27 to B22. For LR20 and LR30.

LR30-12W03



Special PAR30 - Supply Voltage 85-260VAC | Colour Temperature 5000K

Code	Base	LED Qty/W	Total LED Watts	Lumen for CW	Lumen for WW	Beam Angle	Colour Temperature
LR30-12W01	E27	3 x 4W	12W	± 600lm	± 600lm	45°	5000K
LR30-12W03	E27	3 x 4W	12W	± 600lm	± 600lm	15°	5000K

Lamps are supplied with E27 bases. The base can be changed to B22 with a lampholder adaptor.

#### Accessories

Code	Description
LHA-02	Interchangeable adaptor from E27 to B22. For LR20 and LR30.

# PAR LED LAMPS

NEW

- WW - 2700K
- CW - 4200K



## PAR56 - 230VAC | IP20

Code	Base	LED Qty/W	Total LED Watts	Lumen for CW	Lumen for WW	Beam Angle	*Add Colour to Code
HS-PAR56-32-*	E27	16 x 2W	32W	±2600lm	±2400lm	120°	WW / CW



## LED PAR38 Plant Grow - IP65

Code	Base	Watts	Lumen
LED-PAR38-12W-PG	E27	12W	171lm

- 75% Red, 25% Blue
- The wave length for red is 662nm, for blue is 447nm

# LED LAMPS - 230VAC

## Pygmy Lamps - 2 Per Pack

- WW - 2700K
- CW - 4200K



Code	SL-0.5W-E14/2	SL-2.5W-E14/2	LR-0.5W-E14-*/2	LR-0.5W-15D-*/2	LR-0.5W-15S-*/2
Wattage	0.5W	2.5W	0.5W	0.5W	0.5W
Base	E14	E14	E14	BA15D	BA15S
Lumens	15lm	80lm	80lm	30-40lm	30-40lm
Size (mm)	Ø27 x 56	Ø27 x 68	Ø18.5 x 45	Ø18.5 x 45	Ø18.5 x 45
Colour	WW	WW	CW	CW	CW

Supply Voltage: 230VAC

\*Add Voltage to Code: 12VAC/DC, 24VAC/DC, 110VAC, 230VAC

## Lamps



Code	LR-1W-E14 230VAC/2	LR-1W-15S 230VAC/2	LR-1W-E14 12V/2	LR-1W-15S 12V/2	LR-1W-15D 12V/2
Wattage	1W	1W	1W	1W	1W
Base	E14	BA15S	E14	BA15S	BA15D
Lumens	80lm	80lm	80lm	80lm	80lm
Size (mm)	18,5 x 45mm	18,5 x 45mm	18,5 x 45mm	18,5 x 45mm	18,5 x 45mm
Colour	4000K	4000K	4000K	4000K	4000K

## Pygmy Lamps Colour



Code	LED-E14-*/2	P19S-E2701-*/2	LM-LED-*/2
Wattage	2.7W	1.3W	2W
Base	E14	E27	BA15D
Lumens	300lm	117lm	180lm
Size (mm)	Ø31 x 79	Ø37 x 65	Ø22 x 54
Volts	*Add Voltage to Code: 12VAC/DC, 24VAC/DC, 110VAC, 230VAC		*Add Voltage to Code: 12VDC, 24VDC, 110VAC, 230VAC

\*Add colour to code: ○ W (White), ● R (Red), ● GN (Green), ● BL (Blue), ● Y (Yellow)

## LED LAMPS

LED	FLUORESCENT	INCANDESCENT
3W	→ 7W	→ 35W
5W	→ 11W	→ 50W
7W	→ 15W	→ 70W
9W	→ 19W	→ 90W
12W	→ 25W	→ 120W
16W	→ 33W	→ 160W
20W	→ 38W	→ 200W
30W	→ 60W	→ 300W

- WW - 2700K
- CW - 4200K



### LED 2U

Code E27	Code B22	Supply Volts	Wattage	Length	Lumens	*Add Colour to Code
LED2U-3W-E27-*	LED2U-3W-B22-*	230, 12, 24, 48	3W	105mm	240lm	WW / CW
LED2U-5W-E27-*	LED2U-5W-B22-*	12, 24, 48	5W	115mm	400lm	WW / CW

### LED 3U

LED3U-5W-E27-*	LED3U-5W-B22-*	230	5W	135mm	400lm	WW / CW
LED3U-7W-E27-*	LED3U-7W-B22-*	230, 12, 24, 48	7W	145mm	560lm	WW / CW
LED3U-9W-E27-*	LED3U-9W-B22-*	230, 12, 24, 48	9W	145mm	720lm	WW / CW
LED3U-12W-E27-*	LED3U-12W-B22-*	230	12W	170mm	960lm	WW / CW
LED3U-16W-E27-*	LED3U-16W-B22-*	230	16W	175mm	1280lm	WW / CW

### LED 4U

LED4U-20W-E27-*	LED4U-20W-B22-*	230	20W	175mm	1600lm	WW / CW
LED4U-30W-E27-*	LED4U-30W-B22-*	230	30W	255mm	2550lm	WW / CW

\* Add DC Voltages to code: -12VDC, -24VDC, -48VDC

## LED LAMPS

Supply Volts  
230VAC

- WW - 2700K
- CW - 4200K
- DL - 6000K



Code	SDES-906-*	SDES-915-*	SDES-930-*	FX-GRL-4.5W-*	FX-GRL-6.5W-*	FX-GRL-12.5W-*	FX-GRL-18W-*
Wattage	6W	16W	30W	4.5W	6.5W	12.5W	18W
Base	480lm	1280lm	3000lm	E27	E27	E27	E27
Supply Voltage	E27	E27	E27	360-420lm	480-540lm	960-1050lm	1420-1500lm
Size (mm)	Ø38 x 113	Ø43 x 160	Ø82 x 225	Ø32 x 103	Ø41 x 111	Ø61 x 146	Ø84 x 157
*Add colour to code	CW / DL	CW / DL	CW / DL	WW / CW	WW / CW	WW / CW	WW / CW

## LED PENDANT LAMPS

Supply Volts  
230VAC

- CW - 4200K

\* Add Wattage to Code:  
16W, 33W



### R7s Lamps

- DL - 6000K



### R7s Lamps - 360° Beam Angle

- DL - 6000K



Code	LED-CL18*-CW	R7S-LED-4W	R7S-LED-15W	LED-R7S-5W	LED-R7S-8W	LED-R7S-10W	LED-R7S-15W
Wattage	*16W   *33W	4W	15W	5W	8W	10W	15W
Base	E27   E27	R7s	R7s	R7s	R7s	R7s	R7s
Lumens	1440lm   2970lm	380lm	1450lm	500lm	900lm	1100lm	1650lm
Size (mm)	Ø140 x 90   Ø254 x 127	78	189	Ø13 x 78	Ø13 x 118	Ø13 x 118	Ø13 x 189
Colour Temperature	4200K   4200K	6000K	6000K	6000K	6000K	6000K	6000K

## LED PL LAMPS

Supply Volts: 220-240VAC

- WW - 2700K
- CW - 4200K
- DL - 6000K



Code	FBPL-6DW-*	FBPL-8DW-*	FBPL-10DW-*	LEDPL-5W-*	LEDPL-10W-*	LEDPL-12W-*	LEDPL-15W-*
Wattage	6W	8W	10W	5W	10.5W	12W	15W
Lumen	560lm	750lm	940lm	425lm	900lm	1100lm	1400lm
Base	G24d	G24d	G24d	G24d	G24d	G24d	G24d
Size (mm)	Ø35 x L145	Ø35 x L166	Ø35 x L181	Ø44 x 98	Ø34 x 150	Ø35 x 140	Ø35 x 140
*Add colour to code	6000K	6000K	6000K	WW / CW / DL	WW / CW / DL	CW / DL	CW / DL

\* Add - 'EM' to code for Emergency PL Lamp. c/w driver. 3 Hr backup. eg FBPL-10DW-EM

2 Year warranty on all LED products, unless otherwise specified. Warranty void if adequate surge protection is not installed on LED products. See page 147

## LED LAMPS

G9 LED Lamps		2 per pack		2 per pack		2 per pack		2 per pack		2 per pack	
Supply Volts	230VAC										
Code	G9-2W-*/2	G9-3W-*/2	G9-3W-*/2	SG9-3W-*/2	SG9-5W-*/2	DIM-G9-3W-*/2					
Watts	2W	3W	3W	3W	5W	3W					
Lumen	200lm	320lm	320lm	230lm	380lm	300lm					
Size (mm)	Ø16 x 48	Ø23 x 63	Ø23 x 63	Ø16 x 58	Ø16 x 60	Ø19 x 55					
*Add colour to code	WW / CW	WW / CW	WW / CW	WW	WW / CW	WW / CW					
JC LED Lamps		2 / blister pack		2 / blister pack		2 / blister pack		2 / blister pack		2 per pack	
Supply Volts	12V										
Code	JC-0.6W-*/2	JC-1.3W-*/2	JC-1.5W-*/2	JC-2W-*/2	DIM-JC-1.5W-*/2						
Watts	0.6W	1.3W	1.5W	2W	1.5W						
Lumen	40lm	80lm	100lm	150lm	120lm						
Size (mm)	Ø10 x 33	Ø12 x 31	Ø14 x 31.5	Ø14 x 31.5	Ø12 x 31						
*Add colour to code	WW / CW	WW / CW	WW / CW	WW / CW	WW / CW						
G4 LED Lamps		2 / blister pack		2 / blister pack		2 / blister pack		2 / blister pack		2 / blister pack	
Supply Volts	12V	12V	12V	230V	12V	12V	12V	12V	12V	12V	12V
Code	G4-1W-*/2	G4-2.3W-*/2	G4-3W-*/2	G4-2.3W-*/2 230	SHL-G4-1.5W-*/2	SHL-G4-3W-*	DIM-G4-2W-*/2				
Power	1W	2.3W	3W	2.3W	1.5W	3W	2W				
Lumen	50lm	210lm	270lm	210lm	160lm	230lm	200lm				
Size (mm)	Ø10 x 35	Ø16 x 44	Ø16 x 44	Ø16 x 44	Ø10 x 36	Ø16 x 45	Ø16 x 44				
*Add colour to code	WW / CW	WW / CW	WW / CW	WW / CW	WW / CW	WW / CW	WW / CW				
G4 LED Lamps		Side Pins		Bottom Pins		G12 LED Lamps					
Supply Volts	8-30VAC										
Code	EL-G4-1/2	EL-G4-2/2	EL-G4-4/2	HL-G12-10W-*	HL-G12-10W-*/230						
Power	1.2W	1.5W	1.8W	10W	10W						
Lumen	70lm	100lm	120lm	1200lm	1200lm						
Size (mm)	Ø23	Ø28	Ø32	Ø26 x 118	Ø26 x 118						
*Add colour to code	CW (4000K)	CW (4000K)	CW (4000K)	WW / CW	WW / CW						

## LED CORN LIGHTS

High Power Lamps Supply Voltage: 100-250VAC Beam Angle: 360° PF>0.9



Code No Fan	Code Fixed Fan	Code Replaceable Fan	Watts	Lumen	Base	Size (mm)
FX-BL-20W-WW	-	HS-JN01-020-*	20W	1650lm	E27	Ø96x230
FX-BL-30W-WW	-	HS-JN01-030-*	30W	2500lm	E27	Ø96x250
FX-BL-40W-WW	-	HS-JN01-040-*	40W	3500lm	E40	Ø96x290
FX-BL-50W-CW	-	-	50W	4100lm	E40	Ø96x310
FX-BL-60W-WW	-	HS-JN01-060-*	60W	5800lm	E40	Ø96x340
FX-KBL-80W-CW	-	HS-JN01-075-*	75/80W	7200lm	E40	Ø117x350
FX-KBL-100W-*	HS-JN05-100-*	-	100W	9200lm	E40	Ø117x390
FX-KBL-120W-*	HS-JN05-120-*	-	120W	11000lm	E40	Ø117x430

\*Add colour to code: ○ CW (Cool White) 5500-6000K, ○ WW (Warm White) 3000K.  
For spare replacement fan use code: HS-JN01-FAN

NEW

## HP T-LAMPS

- WW - 2700K
- CW - 4200K
- DL - 6500K



Non-Dimmable T-Lamps | 110V Lamp has Over Voltage Protection. Only operates between 110-140VAC

Code	Wattage	*Add Base to Code	Lumens	Supply Voltage	Size (mm)	*Add Colour to Code
TP-DL-5W-*	5W	E27	470lm	170-265VAC	Ø50 x 100	WW / CW
TP-DL-5W-CW 110V	5W	E27	470lm	110VAC	Ø50 x 100	CW
TP-DL-10W-*	10W	E27	870lm	170-265VAC	Ø60 x 119	WW/CW/DL
TP-DL-10W-CW 110V	10W	E27	870lm	110VAC	Ø60 x 119	CW
TP-DL-15W-*	15W	E27	1350lm	170-265VAC	Ø70 x 130	WW / CW
XH-T95-20W-*.*	20W	*E27 / *B22	1600lm	170-265VAC	Ø80 x 145	WW / CW
TP-DL-20W-CW 110V	20W	E27	1600lm	110VAC	Ø80 x 145	CW
XH-T95-30W-*.*	30W	*E27 / *B22	2400lm	170-265VAC	Ø115 x 202	WW / CW
XH-T110-40W-*.*	40W	*E27 / *B22	3600lm	170-265VAC	Ø120 x 200	WW / CW
XH-T149-60W-*	60W	E40	4800lm	170-265VAC	Ø160 x 280	WW/CW/DL
XH-T135-80W-*	80W	E40	7200lm	170-265VAC	Ø151 x 255	WW/CW/DL
XH-T150-100W-*	100W	E40	9000lm	170-265VAC	Ø148 x 260	WW/CW/DL
XH-T158-150W-*	150W	E40	12000lm	170-265VAC	Ø160 x 288	WW/CW/DL

- DL - 6500K



High Power T-Lamps - Optional Reflector | Lamps supplied with E27-E40 Adaptor

Code	Wattage	Base	Lumens	Supply Voltage	Size (mm)	Colour Temp.
CRD-HP80W	80W	E27 & E40	7600lm	230VAC	Ø140 x 300	DL(6500K)
CRD-HP100W	100W	E27 & E40	9000lm	230VAC	Ø140 x 300	DL(6500K)
HN-HB001-150W	150W	E27 & E40	13500lm	230VAC	Ø160 x 325	DL(6500K)
HN-HB001-200W	200W	E27 & E40	18000lm	230VAC	Ø160 x 325	DL(6500K)

### Accessories Code Description

HN-HB001-REF	Optional Reflector for use with HN-HB001-100W / 200W
CRD-HP-REF	Optional Reflector for use with CRD-HP80W / 100W

- DL - 6500K



### High Power Lamps

Code	Wattage	Base	Lumens	Supply Voltage	Size (mm)	Colour Temp.
L-BL-0490	55W	E27	4200lm	85-265VAC	Ø100 x 218	DL(6500K)
L-BL-0494	65W	E40	5400lm	85-265VAC	Ø100 x 300	DL(6500K)
LES-ED120-80W	80W	E40	8800lm	100-240VAC	Ø120 x 285	DL(6500K)
LES-ED120-100W	100W	E40	11000lm	100-240VAC	Ø120 x 285	DL(6500K)
HBL-CNL-65W	65W	E40	5400lm	230VAC	Ø145 x 225	DL(6500K)
HBL-CNL-85W	85W	E40	7200lm	230VAC	Ø170 x 275	DL(6500K)
HBL-CNL-105W	100W	E40	9500lm	230VAC	Ø190 x 275	DL(6500K)

High Power Lamp c/w Reflector - 230VAC | 6500K

HN-HB001-65W	65W	E40	5525lm	230VAC	Ø345 x 110	DL(6500K)
HN-HB001-85W	85W	E40	7225lm	230VAC	Ø400 x 300	DL(6500K)
HN-HB001-105W	100W	E40	8500lm	230VAC	Ø420 x 330	DL(6500K)

## HP T-LAMPS

- WW - 2700K
- CW - 4200K
- DL - 6500K



DTP



L-BL-1001-40W

### Dimmable T-Lamps

Code	Wattage	Base	Lumens	Supply Voltage	Size (mm)	*Add Colour to Code
DTP-DL-5W-*	5W	E27	300-350lm	230VAC	Ø58 x 144	WW / CW
DTP-DL-10W-*	8W	E27	650-700lm	230VAC	Ø68 x 165	WW / CW

**Automatic Dim** - Energy Saving mode or Regular Mode | Sensor Range 7m | Lamp will automatically dim down to save energy when no movement

L-BL-1001-40W	40W	E27 & E40	3500lm	100-240VAC	Ø100 x 218	DL(6500K)
---------------	-----	-----------	--------	------------	------------	-----------

NEW

## HP U-LAMPS

Input Voltage: 90-265VAC | Beam Angle 320° | Colour Temp 6500K

E27-E40 Adaptor



20W



30W



40-50W



60W



70W



100-120W

Code	Wattage	Base	Lumens	Size
HP-2U-20W	20W	E27	1700lm	Ø46 x 194
HP-4U-30W	30W	E27	2550lm	Ø72 x 223
HP-4U-40W	40W	E27	3600lm	Ø72 x 240
HP-4U-50W	50W	E27 & E40	4200lm	Ø72 x 256
HP-5U-60W	60W	E27 & E40	5100lm	Ø88 x 265
HP-5U-70W	70W	E27 & E40	5900lm	Ø88 x 295
HP-8U-100W	100W	E40	9000lm	Ø125 x 310
HP-8U-120W	120W	E40	10200lm	Ø125 x 320

## LED HP

**120° Adjustable Light Panel - IP20** Input Voltage: 100-230VAC | 6000K | Material: Die-Cast Aluminium + PC Beam Angle 120° | CRI>80 | Colour Temp 5500K | Suitable for Garage, warehouse and office



LS-GL-100W-DL

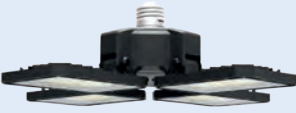

LS-GL-100W-DL

Code	Wattage	Base	Lumens	Size (mm)
LS-GL-60W-DL	60W	E27	6000lm	232 x 214 x 100
LS-GL-100W-DL	100W	E27	10000lm	266 x 266 x 112

**UFO LED Lamp - IP20** Input Voltage: 85-265VAC | Thermal Conductivity Nylon | Beam Angle 120° | CRI 70 | Suitable for Garage, Warehouse and Office



Code	Wattage	Lumens	Size (mm)
L-UFO-30W-DL	30W	3000lm	150 x 100
L-UFO-50W-DL	50W	5000lm	220 x 100



## LED AR111 LAMPS

	Non - Dimmable			Coloured	Dimmable	
<ul style="list-style-type: none"> <li>○ WW - 2700K</li> <li>○ CW - 4200K</li> </ul>						
<b>Code</b>	<b>L058-AR111-12W-*</b>	<b>LEDAR111-12W-*</b>	<b>MDS-AR111-12W-*</b>	<b>LEDAR111-9W-*</b>	<b>KL-AR111-12W-*</b>	<b>KL-AR111-15W-*</b>
Wattage	12W	12W	12W	9W	12W	15W
Base	GU10	G53	GU10	GU10	G53	GU10
Supply Voltage	230VAC	12 -24VAC/DC	230VAC	230VAC	12VAC/DC	230VAC
Lumens	850 - 1100lm	1000lm	1000lm	800lm	850-1100lm	1275lm
Beam Angle	45°	45°	120°	45°	60°	40°
*Add colour to code	<b>WW / CW</b>	<b>WW / CW</b>	<b>WW / CW</b>	<b>●R / ●GN/ ●BL / ●Y</b>	<b>WW / CW</b>	<b>WW / CW</b>

## LED PLL LAMPS

- WW -2700K
- CW -4200K

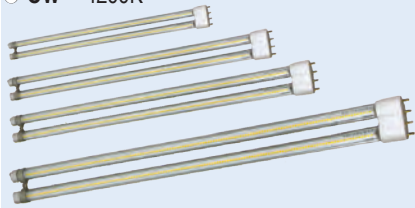

### LED PLL Lamp Series

Code	PLL-226-8W-*	PLL-321-16W-*	PLL-415-20W-*	PLL-541-25W-*
Watts	8W	16W	20W	25W
Voltage	AC100-240V	AC100-240V	AC100-240V	AC100-240V
Lumen	675lm	1380lm	1700lm	2120lm
Size (mm)	Ø41.4 x L210.1	Ø41.4 x L404.1	Ø41.4 x L526.1	Ø41.4 x L526.1
*Add colour to code	<b>WW / CW</b>	<b>WW / CW</b>	<b>WW / CW</b>	<b>WW / CW</b>

## LED RETROFIT LAMPS

### LED 2D Type

- WW - 2700K
- CW - 4200K
- DL - 6000K



### Rechargeable EMG.

Emergency time: 3-4Hrs



### GX53



### LED Circline Lamps - G10q Base.

Internal Driver



Code	2D-LEDR-14W-*	2D-LED-16W-*	2D-LEMG-16W-*	LGX53-8W-*	TOP-C225-16W	TOP-C299-20W
Watts	14W	16W	16W	8W	16W	20W
Voltage	100-240V	100-240V	100-240V	170-260V	90-264V	90-264V
Lumen	1150lm	1700lm	1700lm	620lm	1280lm	1660lm
Size (mm)	Ø224 x 24H	200L x 200W x 31H	200L x 200W x 31H	Ø75 x 29H	Ø225 x 30H	Ø299 x 30H
Base Type	GR10q	GR10	GR8	GX53	G10q	G10q
*Add colour to code	<b>WW / CW</b>	<b>WW / CW</b>	<b>WW / CW</b>	<b>WW / CW / DL</b>	<b>6000K</b>	<b>6000K</b>

NEW

## LED RETROFIT MODULES

Supply Volts  
175 - 265VAC

- WW - 2700K
- CW - 4200K
- DL - 6000K



### Magnetic LED Module for Bulkheads

Code	Power	Lumen	Size (mm)	* Add Colour to code
CP-FD-9W-*	9W	680lm	Ø130 x 24	WW / CW / DL
CP-FD-18W-*	18W	1350lm	Ø170 x 24	WW / CW / DL

- CW - 4200K
- DL - 6500K

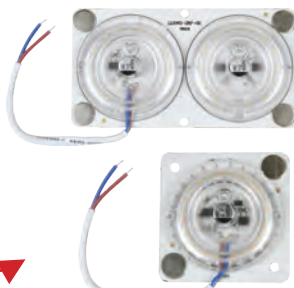
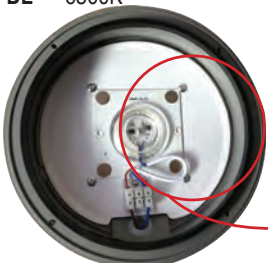

**Universal LED Module** - Input Voltage: 230VAC | Simple Retrofit Solution | 160° Beam Angle | Driver less | 3 Mounting Options; Magnetic, Screws, Double sides heat conductive tape (Tape Included)

Code	Wattage	Lumens	Size (mm)	* Add Colour to code
H-HB-12W-*	12W	1150lm	80 x 80	CW / DL
H-HB-24W-*	24W	2300lm	80 x 160	CW / DL
H-HB-36W-*	36W	3500lm	140 x 140	CW / DL
H-HB-45W-*	45W	4300lm	170 x 170	CW / DL

NEW

## LED MODULES IP67

5 Year Warranty!

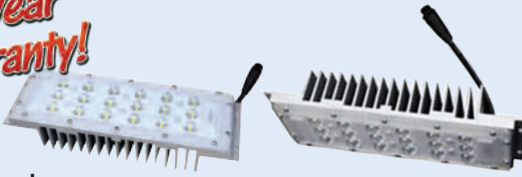

Input Voltage: 36VDC | 6063 Aluminium Alloy Material | Light transmittance is more than 95% | Standardized electrical interface, convenient to install | 6500K | Power Supply not Supplied.

Beam Angle:  
A: 54° / 48°  
B: 90° / 50°  
C: 90°  
D: 60°

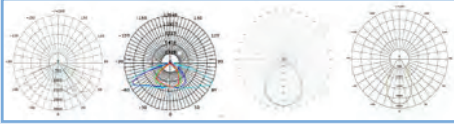

Optical Design

Code	Wattage	Lumens	Current	Beam Angle	Size (mm)
MS02A-50-A	50W	6500lm	1500mA	145° / 100°	300 x 76 x 54
MS02A-50-B	50W	6500lm	1500mA	150° / 70°	300 x 76 x 54
MS02A-50-C	50W	6500lm	1500mA	90°	300 x 76 x 54
MS02A-50-D	50W	6500lm	1500mA	40°	300 x 76 x 54

## SMART CONTROLLABLE LED LAMPS



MR16

GU10



Dimmable and Colour Change Lamps - c/w 24 Key Remote

Code	Colour	Base	Watts	Volts
HS-MR16-RGB 12V	Multi Colour Changing	GU5.3 (MR16)	3W	12VAC/DC
HS-GU10-RGB/W	Multi Colour Changing + White	GU10	5W	110-265VAC



Dimmable

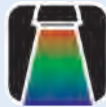

RGB



White

NEW



Bluetooth or WIFI LED Speaker Lamps - Input Voltage: 100-240VAC | E27 base | True Wireless Stereo | Smart Device Control | App for IOS & Android



LMS-20

LMS-40

Code	LMS-20	LMS-40
Description	Bluetooth LED Speaker - Master & Slave	WiFi Speaker - Single Speaker   Multiple speakers can be grouped in app for True Stereo
LED Watts	9W	7W
LED Lumens	600lm	450lm
Colour Temp	2700K - Warm White	2700K - Warm White
Light Beam Angle	120°	120°
Audio Power	15 Watts (Max.) @ 4ohm	15 Watts (Max.) @ 4ohm
Speaker	2" Full Range	2" Full Range
Maximum SPL	90dB (93dB for Master Speaker + Slave Speaker)	90dB
Communication Type	Bluetooth V4.0, Dual Mode	WiFi 2.402 - 2.480 GHz

Adjustable Colour Temperature LED Lamp - Flick Switch off/on to change from one colour temperature to the next. Supply Volts: 220-240VAC



NEW

Code	Wattage	Base	Lumen	Beam Angle
CTA-A60-9W-E27	9W	E27	750lm	180°
CTA-A60-12W-E27	12W	E27	900lm	180°

Adjustable: 3000K - Warm White ; 4200K - Cool White ; 6500K - Daylight

LAMPS

LIGHTING

## SMART WIFI LED BULB

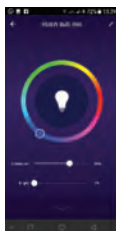

Pick Colour

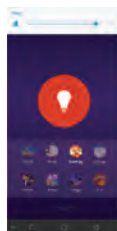

Set Scene



Set Schedule

Input Voltage: 230VAC | Smart Bulb gives you the ability to control lighting in your home remotely, group and set your room atmosphere for different occasions with your smart Phone.

Code	Wattage	Lumens	Base
AS-WF-A60-*	10W	800lm	E27 / B22

\* Add Base to code: E27, B22



WiFi Control



App Control



Remote Switching



Dimmable



Colour RGBW Adjustable



Colour Temp. Adjustable

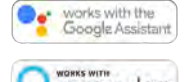

WORKS WITH amazon alexa

## SMART CONTROLLABLE LED LAMPS



**ZYZY-LB-6WR Kit**

**Note:** The ZYZY-LB-6WBB lamps are only compatible with the ZYZY-LB-6WRR remote.

Colour Temperature Adjustable  
Daylight to Warm White  
and Dimmable



### Remote Controlled Lamps - Colour temperature adjustment & dimmable

Supply voltage: 85-265VAC | Lamps are dimmable from 0-100%. Colour Temp can be set from warm white to daylight (2700K-7000K) | Night light function, lamps can be controlled individually or in a group.

Code	Description
<b>ZYZY-LB-6WR</b>	Starter kit including two <b>ZYZY-LB-6WBB</b> lamps and one <b>ZYZY-LB-6WRR</b> remote control.
<b>ZYZY-LB-6WBB</b>	6W LED lamp, dimmable and colour temperature adjustable. 510-560lm: Dependant on the colour temperature. Can be paired with 4 remotes. Can be added to the kit. No limit of number of lamps per Remote Control.
<b>ZYZY-LB-6WRR</b>	Remote control. Functions: ON/OFF, dimmer and colour temperature adjustment. Can control individual lamps or groups of lamps depending on setup. Can be paired with an unlimited amount of lamps.



**1201RGBW**



### IR Adjustable Colour Temperature LED Lamp

Supply Volts: 220-240VAC

Code	Description	Lamp Wattage	Lumen	Lamp Colour	Size (mm)
<b>1201RGBW</b>	IR controlled LED lamp	7W	580lm	RGB + 2700-6500k	Ø68 x 119

#### Lamp Settings

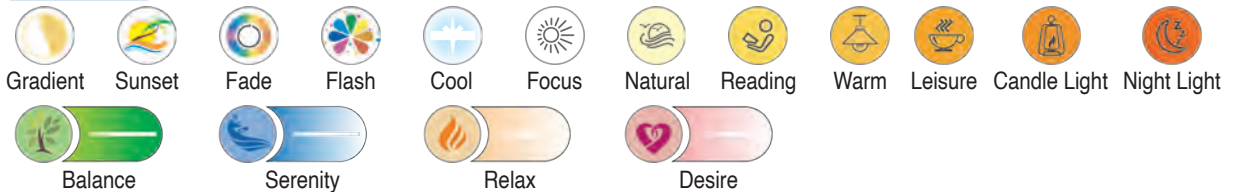

**1201RGBW-WF**



### WiFi Adjustable Colour Temperature LED Lamp

Supply Volts: 220-240VAC

Code	Description	Lamp Wattage	Lumen	Lamp Colour	Size (mm)
<b>1201RGBW-WF</b>	WiFi and IR controlled LED lamp.	7W	470lm	RGB + 2700-6500K	68 x 119
<b>1203RGBW-2S-WF</b>	WiFi and IR controlled LED lamp with Bluetooth speaker.	12W	650lm	RGB + 2700-6500K	73 x 132



**1203RGBW-2S-WF**



**SPEAKER & LAMP**

Lamps are grouped by Room and can be controlled as groups or individually

Easily selectable moods for different occasions

Manually selectable single colours and preset colour changing programs

Manually adjustable colour temperature and brightness

Programmable time delays and alarms



## FLAME SIMULATION LED LAMP

Input Voltage: 85-265VAC | Dynamic Moving Flame | Static On & Flame Effect Controlled by Switch



Code	Wattage	Lumens	Colour Temp	Base	Dimensions
<b>LED-FLAME-E27</b>	5W	250-499lm	1300K/1800K	E27	Ø80 x 134mm

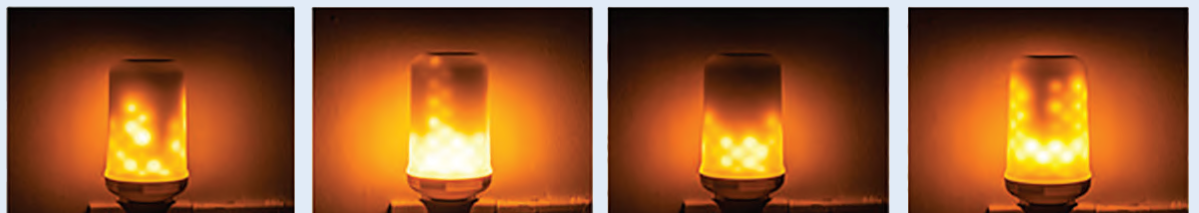

# LED DECORATIVE LAMPS

**NEW**
**Amber LED Filament Lamps - Dimmable 2200K**

Supply Volts: 230VAC

Code	Wattage	Base	Filament Shape	Size (mm)	Colours
BF-G45-L	1W	E27	Loop	Ø45 x 74	WW
BF-A60-Q*	2W	E27 / B22	Quad	Ø60 x 105	WW
BF-C35-Q	2W	E14	Quad	Ø35 x 100	WW
BF-ST64-S	2W	E27	Spiral	Ø64 x 145	WW
BF-G125-S	2W	E27	Spiral	Ø125 x 170	WW
BF-T45-S	2W	E27	Spiral	Ø45 x 110	WW
AS-A60-ST*	2W	E27 / B22	Long	Ø60 x 105	WW
AS-C35-ST	2W	E14	Long	Ø35 x 100	WW
AS-ST64-ST	2W	E27	Long	Ø64 x 145	WW
AS-G125-ST	2W	E27	Long	Ø125 x 170	WW
AS-T45-ST	2W	E27	Long	Ø45 x 110	WW
AS-T30-ST	2W	E27	Long	Ø30 x 295	WW

**Clear LED Decorative Lamps - Scattered LED**

Supply Volts: 230VAC

Code	Wattage	Base	Filament Shape	Size (mm)	Colours
DN-ST64*	3W	E27	Scattered	Ø64 x 150	WW / BL / V / S

\* Add colour to code: ○WW (Warm White) 2700K, ●BL (Blue), ●V (Violet), ●S (7 Colours)

**3D Effect Lamps**

Supply Volts: 230VAC

Code	Wattage	Base	Filament Shape	Size (mm)	Colours
HB-A60-3D	6W	E27	Straight	Ø64 x 140	WW
HB-ST64-3D	6W	E27	Straight	Ø64 x 140	WW
HB-G125-3D	6W	E27	Straight	Ø125 x 176	WW

**Twisted Wire**

Supply Volts: 230VAC

Code	Wattage	Base	Filament Shape	Size (mm)	Colours
WS-G95-WW	1.5W	E27	Twisted	Ø95 x 138	WW
WS-G125-WW	1.5W	E27	Twisted	Ø125 x 175	WW

**Filament Text**

Supply Volts: 230VAC

Code	Wattage	Base	Filament Shape	Size (mm)	Colours
LVE-G125-4W-WW	4W	E27	Love	Ø125 x 176	WW

**Irregular Lamp Shape**

Supply Volts: 230VAC

Code	Wattage	Base	Filament Shape	Size (mm)	Colours
IR-A165-4W-WW	4W	E27	Spiral	Ø160 x 300	WW
IR-BT150-6W-WW	6W	E27	Spiral	Ø150 x 225	WW

**Shattered Glass Effect - 2700K | 360° Beam Angle**

Supply Volts: 230VAC

Code	Wattage	Base	Filament Shape	Size (mm)	Colours
G130-1-WW	6W	E27	Straight	Ø130 x 180	WW
G130-2-WW	6W	E27	Straight	Ø130 x 180	WW
G130-3-WW	6W	E27	Straight	Ø130 x 180	WW
G130-4-WW	6W	E27	Straight	Ø130 x 180	WW
G130-7-WW	6W	E27	Straight	Ø130 x 180	WW
G130-15-WW	6W	E27	Straight	Ø130 x 180	WW

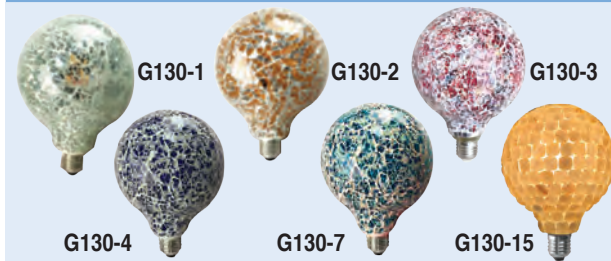
**Ice Flower - 2700K | 360° Beam Angle**

Supply Volts: 230VAC

Code	Wattage	Base	Filament Shape	Size (mm)	Colours
G95-ICE-WH	6W	E27	Straight	Ø95 x 138	WW
G95-ICE-Y	6W	E27	Straight	Ø95 x 138	WW
G125-ICE-WH	6W	E27	Straight	Ø125 x 176	WW
G125-ICE-Y	6W	E27	Straight	Ø125 x 176	WW

 \* Add base to code: **E27** or **B22**
**Coloured G45 - 360° Beam Angle | Single Filament | 2 per Pack | Supply Volts: 230VAC**

Code	Wattage	Base	Filament Shape	Size (mm)	Colours
AG45-1W-R/2	1W	B22	Straight	Ø45 x 74	● Red
AG45-1W-GN/2	1W	B22	Straight	Ø45 x 74	● Green
AG45-1W-BL/2	1W	B22	Straight	Ø45 x 74	● Blue
AG45-1W-Y/2	1W	B22	Straight	Ø45 x 74	● Yellow
AG45-1W-P/2	1W	B22	Straight	Ø45 x 74	● Purple

**Coloured G95 - 360° Beam Angle | Single Filament**

Supply Volts: 230VAC

Code	Wattage	Base	Filament Shape	Size (mm)	Colours
G95-2W-R	2W	E27	Straight	Ø95 x 140	● Red
G95-2W-G	2W	E27	Straight	Ø95 x 140	● Green
G95-2W-BL	2W	E27	Straight	Ø95 x 140	● Blue
G95-2W-Y	2W	E27	Straight	Ø95 x 140	● Yellow
G95-2W-P	2W	E27	Straight	Ø95 x 140	● Purple

 LAMPS  
LIGHTING

## CARBON FILAMENT



Carbon Filament Lamps - 110-240V | Dimmable

Code	Power	Base	Filament Shape	Size (mm) Ø x H
<b>Globe Type</b>				
A21-25W-*	25W	E27/B22	Quadloop	68 x 125
A21-40W-*	40W			
A21-60W-*	60W			
<b>Candle Flame Type</b>				
FC35-25W-E14	25W	E14	Z-Style	35 x 120
FC35-40W-E14	40W			
<b>Pear Shape Type</b>				
ST58-40W-*	40W	E27/B22	Squirrel Cage	58 x 135
ST58-60W-*	60W			
<b>Large Ball Type</b>				
G125-40W-*	40W	E27/B22	Squirrel Cage	125 x 175
G125-60W-*	60W			

\*Add base to code: **E27** or **B22**

## PYGMY - INCANDESCENT

	Fridge	Oven 300°C	Oven 300°C	Oven 300°C	Oven 300°C
<b>Code</b>	FPL-15W-E14	OPL-15W-E14	OPL-25W-E14	OPL-40W-E14	OPL-40W-E27
<b>Wattage</b>	15W	15W	25W	40W	40W
<b>Base</b>	E14	E14	E14	E14	E27
<b>Lumens</b>	150lm	150lm	250lm	400lm	400lm
<b>Size(mm)</b>	Ø26 x 56	Ø25 x 55	Ø25 x 55	Ø75 x 45	Ø45 x 73
<b>Colour</b>	2700K	2700K	2700K	2700K	2700K

## STANDARD FILAMENT LAMPS



Halogen Classic A60 - 230VAC | Ø60 x 107

Code E27	Code B22	Code E14	Watts	Lumen
A60-28-E27	A60-28-B22	-	28W	672lm
A60-42-E27	A60-42-B22	-	42W	1008lm
A60-72-E27	A60-72-B22	-	72W	1728lm

Incandescent A60 - 230VAC or 110VAC

E27-25-*	-	-	25W	350lm
----------	---	---	-----	-------

\*Add voltage to code: **230V** or **110V**

Incandescent Golf Ball Lamps - 230VAC | Ø45 x 77

E27-15-*	B22-15-*	-	15W	210lm
----------	----------	---	-----	-------

\*Add colour to code: ● **R** (Red), ● **GN** (Green), ● **Y** (Yellow)

Halogen Flame Lamps - 230VAC

FLM-E27-28W	-	FLM-E14-28W	28W	672lm
FLM-E27-42W	-	FLM-E14-42W	42W	1008lm

Incandescent Flicker Flame Lamps - 230VAC

-	-	FFL-E14-3W	3W	42lm
---	---	------------	----	------

## ENERGY SAVING LAMPS & HOLDERS

Energy Saving Compact Fluorescent Lamps • 8000 hrs

Code	Wattage	Base	Length	Base Code
<b>2 Pin type Inline</b>				
PL-7-*	7W	G23	137mm	BCF-G23
PL-9-*	9W	G23	167mm	BCF-G23
PL-9-CW 110V	9W	G23	167mm	BCF-G23
PL-11-*	11W	G23	237mm	BCF-G23
PL-13-*	13W	G23	188mm	BCF-G23
<b>2 Pin Type Off Centre</b>				
PLC-13-*	13W	G24d1	130mm	BCF-G24d1
PLC-18-*	18W	G24d2	152mm	BCF-G24d2
PLC-26-*	26W	G24d3	167mm	BCF-G24d3
<b>4 Pin Type</b>				
PLCE-13-*	13W	G24q1	132mm	BCF-G24q1
PLCE-18-*	18W	G24q2	144mm	BCF-G24q2
PLCE-26-*	26W	G24q3	165mm	BCF-G24q3
PLCE-42-*	42W	G24q4	168mm	BCF-G24q4

\*Add to code: ○ **CW** (Cool White, 4000K), ○ **WW** (Warm White, 2700K)



PL-7-CW



PLC-26-CW



PLCE-13-CW



BCF-G23

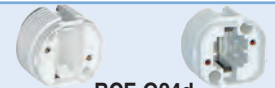







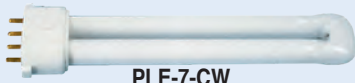

BCF-G24d











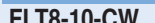
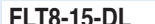



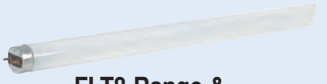

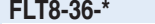
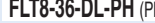
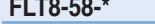

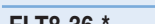

BCF-G24q

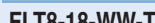
## ENERGY SAVING LAMPS & HOLDERS

	Code	Wattage	Base	Length	Base Code	
	PLE-7-*	7W	2G7	122mm	BCF-2G7	 <b>BCF-2G7</b> 
	PLE-9-*	9W	2G7	152mm	BCF-2G7	
	PLE-11-*	11W	2G7	222mm	BCF-2G7	
*Add to code: ○ CW (Cool White, 4000K), ○ WW (Warm White, 2700K)						
	NB5025-18-*	18W	2G11	227mm	BCF-2G11	 <b>BCF-2G11</b> 
	NB5025-24-*	24W	2G11	322mm	BCF-2G11	
	NB5025-36-*	36W	2G11	417mm	BCF-2G11	
	NB5025-55-*	55W	2G11	542mm	BCF-2G11	
*Add ○ CW (Cool White, 4000K), ○ WW (Warm White, 2700K), ○ D (Daylight, 6500K)						
	2D-16-*	(2 Pin) 16W	GR8	139mm	BCF-GR8	 <b>BCF-GR8</b> 
	2D-16-4P-CW	(4 Pin) 16W	GR10q	139mm	BCF-GR10q	
	2D-21-*	(2 Pin) 21W	GR8	139mm	BCF-GR8	
	2D-28-*	(2 Pin) 28W	GR8	202mm	BCF-GR8	
	2D-28-4P-*	(4 Pin) 28W	GR10q	202mm	BCF-G10q	
*Add to code: ○ CW (Cool White, 4000K), ○ WW (Warm White, 2700K)						

## FLUORESCENT LAMPS

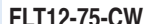
T5 Lamps							T8 Lamps						
Code	Colour Temp.	Type	Length	Watts	Lumen		Code	Colour Temp.	Type	Length	Watts	Lumen	
	FLT5-6-CW	4000K	T5	225mm	6W	240lm		4000K	T8	1FT	10W	650lm	
	FLT5-8-CW	4000K	T5	300mm	8W	380lm		6500K	T8	450mm	15W	900lm	
	FLT5-13-CW	4000K	T5	517mm	13W	1010lm		4000K	T8	2FT	18W	1100lm	
	FLT5-14-CW	4000K	T5	563mm	14W	1200lm		6500K	T8	2FT	18W	1100lm	
	FLT5-14-DL	6500K	T5	563mm	14W	1200lm		2700K	T8	2FT	18W	1100lm	
	FLT5-21-CW	4000K	T5	863mm	21W	1870lm		4000K	T8	3FT	30W	2350lm	
	FLT5-28-CW	4000K	T5	1163mm	28W	2600lm		-	T8	4FT	36W	3350lm	
	FLT5-28-0-CW (Osram)	4000K	T5	1163mm	28W	2600lm		6500K	T8	4FT	36W	3350lm	
	FLT5-28-DL	6500K	T5	1163mm	28W	2600lm		-	T8	5FT	58W	5200lm	
	FLT5-32-CW	4000K	T5	1210mm	32W	3300lm	*Add colour temp. to code: <b>SNW</b> (Snow White - 12000K), <b>WW</b> (Warm White - 2700K), <b>CW</b> (Cool White - 4000K), <b>DL</b> (Daylight - 6500K), <b>SW</b> (Skywhite - 8000K)						
	FLT5-35-CW	4000K	T5	1449mm	35W	3135lm	<b>T8 Coloured Lamps</b>						
	FLT5-35-DL	6500K	T5	1449mm	35W	3135lm		Y	T8	4FT	36W	2800lm	
	FLT5-49-CW	4000K	T5	1449mm	49W	4000lm		R, Y, BL	T8	5FT	58W	4100lm	
	FLT5-54-CW	4000K	T5	1149mm	54W	4200lm	<b>T8 Triphosphour Lamps</b>						
	FLT5-54-CDL	6500K	T5	1149mm	54W	4200lm		2700K	T8	2FT	18W	1100lm	
	FLT5-80-CW	4000K	T5	1449mm	80W	7000lm		2700K	T8	4FT	36W	2800lm	
	FLT5-80-SW	8000K	T5	1449mm	80W	6500lm		2700K	T8	5FT	58W	4800lm	
<b>Black Ultra Violet Lamps - 3000h life (Osram Lamps)</b>							<b>T8 Energy Saving Lamps</b>						
	FLT5-6UV	G5	T5	225mm	6W	-		6500K	T8	5FT	23W	1900lm	
	FLT5-8UV	G5	T5	300mm	8W	-		6500K	T8	5FT	37W	3215lm	
	FLT8-18UV	G13	T8	2FT	18W	-	c/w special starter. Only for use with magnetic switchgear.						
	FLT8-36UV	G13	T8	4FT	36W	-	<b>T12 Lamps</b>						
	L30W/76	G13	T8	3FT	30W	1300lm		4000K	T12	5FT	65W	4400lm	
	L36W/76	G13	T8	4FT	36W	1800lm		4000K	T12	8FT	75W	6600lm	
	L58W/76	G13	T8	5FT	58W	2850lm							

**Fluorescent Colour/ Lamp Protection** - The coloured "Tubos" are a practical and economical solution for transforming a normal fluorescent lamp into a coloured one. AC/DC Tubos will give you protection, economy, UV-ray filters and coloured lamps. Suited for the Food & Beverage industry

Code	Exterior Ø	Interior Ø	Wattage	Length	*Add Colour to Code:
AKO-TUBO18-*	28.7mm	26mm	18W	590mm	T (Transparent), ●BL, ●G, ●R
AKO-TUBO36-*	28.7mm	26mm	36W	1200mm	T (Transparent), ●BL, ●G, ●R
AKO-TUBO58-*	28.7mm	26mm	58W	1500mm	T (Transparent), ●BL, ●G, ●R, ●Y
AKO-TUBO28-T	18.7mm	16mm	28W	1149mm	T (Transparent)
AKO-TUBO35-T	18.7mm	16mm	35W	1449mm	T (Transparent)

## T8 to T5 CONVERSION

Convert your existing T8 Light Fittings to Energy Saving T5

- CW - 4000K
- DL - 6000K

without reflector

with reflector

1. Wiring diagram for retrofit into fluorescent fitting with electronic ballast



2. When tube is replaced in a standard fluorescent fitting with magnetic ballast

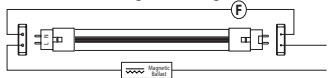

**T8-T5 Conversion - No Reflector.** (Supplied with lamp) PF:0.9

Code	To Fit T8	T5 Power	Size	Replacement Lamp	Colours
EL-T8/T5-14W-*	2ft-18W	14W	588 x 24 x 35mm	FLT5-14W	CW / DL
EL-T8/T5-21W-*	3ft-30W	21W	892 x 24 x 35mm	FLT5-21W	CW / DL
EL-T8/T5-28W-*	4ft-36W	28W	1197 x 24 x 35mm	FLT5-28W	CW / DL
EL-T8/T5-35W-*	5ft-58W	35W	1498 x 24 x 35mm	FLT5-35W	CW / DL

**T8-T5 Conversion - With Reflector.** (Supplied with lamp) PF:0.9

Code	To Fit T8	T5 Power	Size	Replacement Lamp	Colours
ELR-T8/T5-14W-CW	2ft-18W	14W	588 x 45 x 35mm	FLT5-14W	CW
ELR-T8/T5-21W-CW	3ft-30W	21W	892 x 45 x 35mm	FLT5-21W	CW
ELR-T8/T5-28W-CW	4ft-36W	28W	1197 x 45 x 35mm	FLT5-28W	CW
ELR-T8/T5-35W-*	5ft-58W	35W	1498 x 45 x 35mm	FLT5-35W	CW / DL

### Accessories

Code	Description
EL-FL	Fuse link to replace starter in switch start fittings

For retrofit into switch start fittings Power Factor capacitor should be removed and fuse link used instead of starter. For retrofit into electronic fittings rewiring is required. Please contact technical call centre for more information and wiring diagrams.

## INFRARED PAR38

Mainly used in chicken farming.



**Infrared Heat Lamp - 230VAC**

Code	PAR38-IR-175W
Power	175W
Lamp Base	E27
Lamp Life	5000h



**Heat Lamp Fitting**

Code	HLF-01
Material	Bakelite
Size	Ø 145 x 180mm

## BLACK LIGHTS (UV LIGHTS)



UV2U

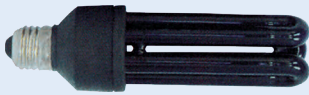

UV3U

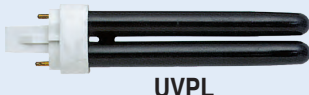

UVPL

For UV LED Floodlight see page 28

**Energy Saving Black Lights - E27**

Code	Wattage	Size (mm)
UV2U-11	11W	165 x Ø 45
UV3U-15	15W	140 x Ø 50
UV3U-20	20W	155 x Ø 50
UV3U-25	25W	170 x Ø 50

**PL Lamps**

Code	Wattage	Base
UVPL-9	9W	G23
UVPL-13	13W	G23
UVPLC-13	13W	G24d1
UVPLC-18	18W	G24d2
UVPLC-26	26W	G24d3

## HIGH POWER CFL LAMPS



Watts	Lumen	D Type Code	Length	F Type Code	Length	S Type Code	Length	SM Type Code	Length
30W	1530lm	-	-	F17-LH30-E27	168mm	-	-	-	-
40/45W	2040lm	-	-	F17-LH45-E27	220mm	-	-	-	-
50/55W	3000lm	-	-	F17-LH55-E40	260mm	-	-	-	-
65W	3315lm	ESL42-65- <b>*-D</b>	258mm	F17-LH65-E40	285mm	S17-FSP-65-E27	205mm	SM42-65-E27	152mm
80W	4335lm	ESL42-80-E40-D	293mm	-	-	S17-FSP-80-E27	255mm	-	-
85W	4335lm	-	-	F17-LH85-E40	280mm	-	-	-	-
125W	4620lm	ESL42-125-E40-D	335mm	F17-LH120-E40	305mm	-	-	-	-
150W	5500lm	ESL42-150-E40-D	355mm	F17-LH150-E40	305mm	-	-	-	-
180W	8640lm	ESL42-180-E40-D	345mm	-	-	-	-	-	-
200W	9600lm	ESL42-200-E40-D	360mm	-	-	-	-	-	-
250W	14850lm	ESL42-250-E40-D	400mm	-	-	-	-	-	-

\*Add to code: E27, E40

# ENERGY SAVING LAMPS - TUBULAR

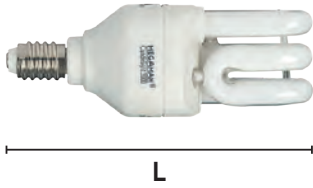

**Tubular** - 15000 hours lifetime 220-240VAC

Code Warm White	L(mm)	Watts	Base	Colour	Code Cool White	Watts	Base	Colour
SU207-E14-WW	103	7W	E14	2700K	SU207-E14-CW	7W	E14	4000K

# ENERGY SAVING LAMPS

Simple Replacement

CFL	→	GLS
9W	→	45W
11W	→	60W
15W	→	75W
20W	→	100W

**Globe Compact Fluorescent Lamp** - Replacement for Standard Incandescent Globe 230VAC

Code E27	Code B22	Watts	Length	Lumen
ES-A60-E27-11-*	ES-A60-B22-11-*	11W	110mm	500lm
ES-A60-E27-15-*	ES-A60-B22-15-*	15W	120mm	800lm
ES-A60-E27-20-WW	ES-A60-B22-20-*	20W	130mm	1000lm

\*Add colour to code: ○ CW (Cool White), ○ WW (Warm White)

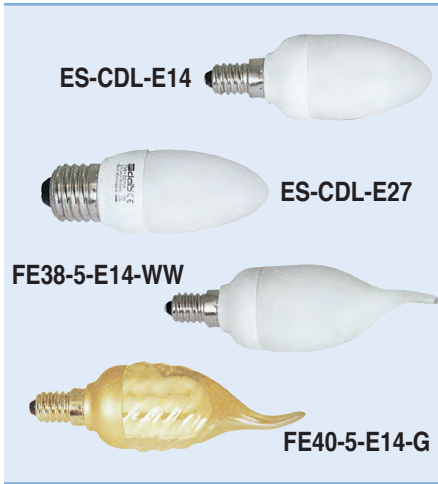

**Candle Light Compact Fluorescent Lamps** - 230VAC

Code E14	Code E27	Code B22	Watts	Length	Lumen
-	ES-CDL-E27-5-*	-	5W	98mm	200lm
-	ES-CDL-E27-7-*	ES-CDL-B22-7-*	7W	98mm	280lm
ES-CDL-E14-9-*	ES-CDL-E27-9-*	ES-CDL-B22-9-CW	9W	108mm	380lm
-	-	-	5W	125mm	180lm
FE38-7-E14-WW	-	-	7W	125mm	280lm
FE38-9-E14-WW	-	-	9W	135mm	380lm
FE40-5-E14-G	-	-	5W	125mm	180lm
FE40-7-E14-G	-	-	7W	127mm	300lm

\*Add colour to code: ○ CW (Cool White), ○ WW (Warm White)



**Large Size Candle Light Compact Fluorescent Lamps** - 230VAC

-	FE36-5-E27-WW	-	5W	149mm	180lm
FE36-7-E14-WW	-	FE36-7-B22-WW	7W	149mm	280lm
FE36-9-E14-WW	FE36-9-E27-WW	-	9W	169mm	380lm
-	FE36-11-E27-WW	FE36-11-B22-WW	11W	169mm	500lm



**Golf Ball Compact Fluorescent Lamp** - 230VAC

GA607-E14-*	GA607-E27-*	GA607-B22-*	7W	89mm	-
-------------	-------------	-------------	----	------	---

\*Add colour to code: ○ CW (Cool White), ○ WW (Warm White), ● R (Red), ● GN (Green), ● Y (Yellow)

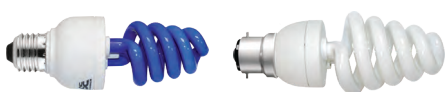

**Spiral Compact Fluorescent Lamp** - 230VAC

-	FE35-15-E27-*	FE35-15-B22-*	15W	128mm	701lm
---	---------------	---------------	-----	-------	-------

\*Add colour to code: ○ CW (Cool White), ○ WW (Warm White), ● O (Orange)



**Mosquito Repelling Lamp** - 230VAC

Code	Description	Length
RDZ-15-25B-MOS	15W E27	135mm



**Dimmable range 15 000 hours lifetime 220-240VAC**

Code	Watts	Base	Colour Temp.	Length
GK715S	15W	E27	2700K	128mm

4-step dimming (100%-66%-33%-5%)

**4-Step Dimming** - Every Dimmable Compact Fluorescent switching OFF/ON will activate the dimming program of the lamp. The brightness of the lamp can be adjusted from 100% to 66%, 33% or 5% with consecutive switching OFF/ON action within 1 second.

LAMPS  
LIGHTING



## ENERGY SAVING LAMPS

Energy Saving Compact Fluorescent Lamps 230VAC - Warm white - 2700K; Cool white - 4000K



FE1 FE27 FE35



FE10 FE29 & FE50 FE32



FE16 FE18\*

\*With daylight sensor. Supply Voltage 230VAC

Code E27	Code B22	Watts	Length	Lumen
FE1-7-E27-WW	-	7W	135mm	238lm
FE1-9-E27-WW	FE1-9-B22-WW	9W	136mm	367lm
-	FE1-11-B22-WW	11W	146mm	449lm

For E14 replace B22 with E14

FE27-20-E27-WW	-	20W	155mm	935lm
FE27-20-E27-WW/10 (PACK OF 10)	-	20W	155mm	935lm
-	FE27-25-B22-WW	25W	172mm	1360lm
FE35-11-E27-WW	FE35-11-B22-WW	11W	122mm	449lm
FE35-20-E27-WW	FE35-20-B22*	20W	141mm	935lm
-	FE35-26-B22-WW	26W	165mm	1326lm
-	FE10-11-B22-WW	11W	Ø90	443lm
-	FE10-16-B22-WW	16W	Ø100	695lm
-	FE10-18-B22-WW	18W	Ø100	833lm
-	FE10-24-B22-WW	24W	Ø120	1105lm
FE29-9-E27*	FE29-9-B22*	9W	152mm	360lm
FE29-11-E27-WW	FE29-11-B22-CW	11W	152mm	443lm
FE50-15-E27*	FE50-15-B22*	15W	164mm	695lm
-	FE32-22-B22-WW	22W	Ø210	1900lm
-	FE16-20-B22-WW	20W	170mm	895lm
-	FE18-S11-B22-WW	11W	109mm	550lm
-	FE18-S20-B22-*	20W	144mm	1080lm

\*Add colour to code: ○ CW (Cool White), ○ WW (Warm White)



FE66 ERF ERB LUXPAR56

### Reflective Type

FE66-11-E27-WW	FE66-11-B22-WW	11W	R80	449lm
ERF-15-E27-CW	ERF-15-B22-CW	15W	R80	701lm
ERB-20-E27-CW	-	20W	PAR38	935lm
ERB-25-E27-CW	-	25W	PAR38	1265lm
<b>PAR56</b>				
LUXPAR56-CW	-	23W	PAR56	980lm
LUXPAR56-WW	-	23W	PAR56	980lm



SP2007/9 SP20011/13

GU10 CFL 12000hrs - Not Dimmable 220-240VAC

Watts	Warm White 2700K	Cool White 4000K	Daylight 6500K	Lens	Length
7W	SP2007-WW	SP2007-CW	-	Diffused	68mm
9W	SP2009-WW	SP2009-CW	SP2009-DL	Diffused	78mm
11W	SP20011-WW	SP20011-CW	SP20011-DL	Diffused	84mm
13W	SP20013-WW	SP20013-CW	SP20013-DL	Diffused	86mm

R50/E14 CFL 15000hrs



BR0107 MM166

Watts	Warm White 2700K	Cool White 4000K	Lens	Length
7W	BR0107-WW	BR0107-CW	Clear	-

### Accessory

Code	Description
MM166	Reflector for BR0107 Ø80 x 54H (mm)

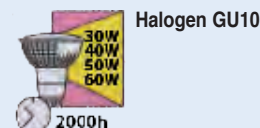

MR16/GU5.3 12000hrs - 220-240VAC

Watts	Warm White 2700K	Cool White 4000K
7W	LUX240-7-WW	LUX240-7-CW
9W	LUX240-9-WW	LUX240-9-CW
11W	LUX240-11-WW	LUX240-11-CW

MR16/GU5.3 8000hrs - 12VAC/DC

Watts	Warm White 2700K	Cool White 4000K
7W	KS-MR16-7-WW	KS-MR16-7-CW
9W	KS-MR16-9-WW	KS-MR16-9-CW
11W	KS-MR16-11-WW	KS-MR16-11-CW

Cat's Eye Glo-in-the-dark Lamps



Code	GSU111-IAG
Watts	11W
Base	E27

Lamp will glow in the dark for approximately 20 min after it has been switched off

## DC ENERGY SAVING LAMPS



### DC Lamps 8000 Hour Life

Code E27	Code B22	Watts	Lumen	Length (H)
FE1-7-E27**	FE1-7-B22**	7W	238lm	124mm
FE1-9-E27**	FE1-9-B22**	9W	367lm	136mm
FE1-11-E27**	FE1-11-B22**	11W	449lm	146mm
FE27-15-E27**	FE27-15-B22**	15W	701lm	139mm
FE27-20-E27**	FE27-20-B22**	20W	935lm	164mm
-	FE36-5-B22-W*	5W	180lm	108mm
-	FE36-7-B22-W*	7W	270lm	108mm
-	FE36-9-B22-W*	9W	400lm	117mm
-	FE36-11-B22-W*	11W	500lm	136mm

\*Supply Voltage: 12VDC, 24VDC | \*Add "-CW" for cool white or "-WW" for warm white

### DC Lamps 15000 Hour Life

CF1-9-E27-12VDC	-	9W	367lm	140mm
-----------------	---	----	-------	-------

## ENERGY SAVING LAMPS & FITTINGS



### Classic – 15000 hours lifetime 220-240VAC

Code Warm White	L (mm)	Watts	Base	Colour	Code Cool White	Watts	Base	Colour
-	-	-	-	-	GSU109-E27-CW	9W	E27	4000K
GSU520-E27-WW	140	20W	E27	2700K	GSU520-E27-CW	20W	E27	4000K
-	-	-	-	-	GSU109-B22-CW	9W	B22	4000K
GSU111-B22-WW	113	11W	B22	2700K	GSU111-B22-CW	11W	B22	4000K
GSU515-B22-WW	116	15W	B22	2700K	GSU515-B22-CW	15W	B22	4000K

### PAR's

- CW (Cool White),
- WW (Warm White)
- W (Warm White),
- GN (Green)



### AR111 CFL Aluminium Reflector - Replaced AR111 Halogen Lamps 12000hrs | Supply Voltage 220-240VAC

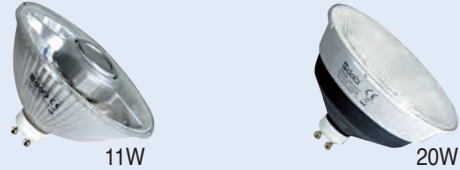

Code	BR01111-*	BR0620-*	Warm White 2700K	Cool White 4000K	Watts	Base	Type	Replaces Halogen
Size	E27/R63	E27/PAR38	LUXES111-WW	LUXES111-CW	11W	GU10	Spot (60°)	75W
Watts	11W	20W	EF-AR111-WW	EF-AR111-CW	20W	GU10	Flood (105°)	50W

\*Add colour to code: **WW / CW**      **W / GN**

### G9 Energy Saving Lamps 10 000 hours

Supply Voltage 220-240VAC

Code	Watts	Base	Lumen	Length
S-AE-7-*	7W	G9	445	69mm
S-AE-9-*	9W	G9	585	75mm

\* Add 'CW' for cool white or 'WW' for warm white  
Perfect replacement for hot G9 lamps  
Diameter of lamp: 37mm  
Produces less heat and consumes less energy



### Mini-twist Energy Saver 9W



Code	MHS9W-GU10-WW
Watts	9W
Base	GU10
Length	90mm

### Self Ballasted Plug-in Lamp 10 000 hours 220-240VAC

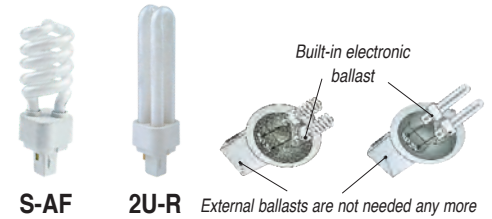

Code	Base	Lumen	Length
S-AF-10-*	10W G24d-1	530	105mm
S-AF-13-*	13W G24d-1	700	112mm
S-AF-18-*	18W G24d-2	950	123mm
2U-R-10-*	10W G24d-1	500	127mm
2U-R-13-*	13W G24d-1	650	137mm
2U-R-18-*	18W G24d-2	900	147mm
3U-R-26-WW	26W G24d-3	1300	167mm

\* Add 'CW' for cool white or 'WW' for warm white

## DOUBLE ENDED HALOGEN LINEAR LAMPS

Expected lamp life 2000hrs | Supplied 2 per pack /2

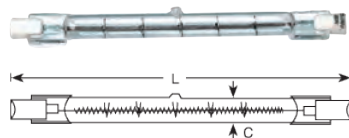

Code	Watts	Lumens	Base	Length	Code	Watts	Lumens	Base	Length
HD-150-78/2	150W	2100lm	R7s	78mm	HD-500/2	500W	9500lm	R7s	118mm
HD-150-118/2	150W	2100lm	R7s	118mm	HD-1000/2	1000W	21000lm	R7s	189mm
-	300W	4800lm	R7s	118mm	HD-1500	1500W	33000lm	R7s	254mm

## HALOGEN CAPSULE LAMPS

Halogen Lamps - Colour Temp: 2900K | Some supplied with 2 per pack as shown in code /2



Halogen Code	Watts	Voltage	Base Type	Luminous Intensity (lm)	Size L x Ø (mm)
JCD-50/2	50W	220-240V	G6.35	600	45 x 13
JCD-100/2	100W	220-240V	G6.35	1200	54 x 13
JCD-150	150W	220-240V	G6.35	2100	54 x 13
JD-100	100W	220-240V	BA15d	1150	75 x 14



Halogen Flood Lamps - Replacement for Incandescent Reflector Lamps | Beam Angle 30°

Code	Watts	Voltage	Base	Luminous Intensity (lm)	Size L x Ø (mm)
PAR16FL	50W	220-240V	E27	250	75 x 51
PAR20FL	50W	220-240V	E27	350	80 x 64.5

## INCANDESCENT LAMPS



Incandescent Lamps

Type	E14	Watts	BA15D	Watts	BA15D	Watts	E14	Watts	BA15D	Watts
Size	16 x 45		16 x 45		35 x 56		45 x 75		16 x 54	
Volts: *12	ACL1*	5	ACL31*	5	-	45	-	-	-	7
*24	ACL1*	5	ACL31*	5	ACL42*	45	-	-	ACL61*	7
*110/130	ACL1*	7/10	ACL31*	10	-	-	ACL51*	40	ACL61*	7
*230/240	ACL1*/2	7/10	ACL31*	10	-	-	ACL51*	40	ACL61*	7



Code	Watts	Base
PAR56 - For swimming pools   12V		
ACL81	120W	Fast on
PAR46 - For swimming pools   12V		
ACLP46	100W	Fast on
PAR38 - 230/240V		
ACL91	75W	E27
ACL92	100W	E27
ACL93	150W	E27

Code	R	Watts	Base
Frosted Reflective- 230/240V			
ACL71	50	40W	E14
ACL72	50	40W	E27
ACL73	63	60W	E27
ACL74	80	75W	E27
ACL75	80	100W	E27

## DICHROIC LAMPS



Halogen Lamp 2000-3000hrs Colour Temp K = 2900 \*Xenon Lamp 12V 8000hrs • Xenon Lamp (GU) 230V 5000hrs



Halogen Code	Watts	Voltage	Base Type	Beam Angle	Luminous Intensity (lm)	*Xenon Code
<b>Open Type</b>						
MR11-20*	20W	12V	GU4/GZ4	30°	1100	-
MR16-20*	20W	12V	GU5.3	36°	500	-
-	35W	12V	GU5.3	36°	850	XMR16-35
-	50W	24V	GU5.3	36°	1550	*XMR16-50
GU10-35*	35W	230V	GU10	30°	600	XGU10-35
GU10-50*	50W	230V	GU10	30°	1000	XGU10-50
<b>Closed Type</b>						
MR11S-20	20W	12V	GU4	30°	1100	-
MR16S-20*	20W	12V	GU5.3	36°	500	-
MR16S-35*	35W	12V	GU5.3	36°	850	-
MR16S-50*	50W	24V/230V	GU5.3	36°	1550	*XMR16S-50
GU10S-35*	35W	230V	GU10	30°	600	XGU10S-35
<b>Closed Type Coloured Lens</b>						
MR16S-20*	20W	12V	GU5.3	24°	950	-
MR16S-35*	35W	12V	GU5.3	24°	1800	-
MR16S-50*	50W	12V	GU5.3	24°	3000	-

\*Add /2 for pack of 2

\*Add colour of lens to code: ● R (Red), ● G (Green), ● Y (Yellow), ● B (Blue) or ● P (Purple)

**METAL HALIDE LAMPS**

	Double Ended		G12 Single Ended			Tubular	
Code	HQI-TS-70W	HQI-TS-150W	HCI-T-35W	HCI-T-70W	HCI-T-150W	HQI-T-250W	HQI-T-400W
Power	70W	150W	35W	70W	150W	250W	400W
Current	1A	1.80A	0.5A	1.0A	1.2A	3.0A	4.1A
Finish	Clear	Clear	Clear	Clear	Clear	Clear	Clear
Lamp base	RX7s	RX7s	G12	G12	G12	E40	E40
Lumen	5800lm	13000lm	3400lm	6800lm	10500lm	20000lm	36000lm
Colour Temp.	Natural Daylight 4200K		Natural Daylight 4200K			Natural Daylight 4200K	

	Elliptical			1000W		Double Ended	
Code	HQI-E-150W	HQI-E-250W	HQI-E-400W	HQI-T-1000W	HQI-T-2000W	HQI-TS-1000	HQI-TS-2000
Power	150W	250W	400W	1000W	2000W	1000W	2000W
Current	1.8A	2.1A	3.7A	9.7A	10.3A	8.6A	11.3A
Finish	Coated	Coated	Coated	Clear	Clear	Clear	Clear
Lamp base	E27	E40	E40	E40	E40	X528	X528
Lumen	12100lm	21500lm	40000lm	90000lm	220000lm	85000lm	230000lm
Colour Temp.	4200K	4200K	4200K	4400K	4200K	7250K	6100K

**HIGH PRESSURE SODIUM LAMPS**

	Tubular				
Code	NAV-T-70W	NAV-T-150W	NAV-T-250W	NAV-T-400W	NAV-T-1000W
Power	70W	150W	250W	400W	1000W
Current	1A	1.80A	3A	4.50A	10.6A
Finish	Clear	Clear	Clear	Clear	Clear
Lamp base	E27	E40	E40	E40	E40
Lumen	6600lm	17500lm	33200lm	56500lm	130000lm

	Elliptical				Internal Ignitor
Code	NAV-E-70W	NAV-E-150W	NAV-E-250W	NAV-E-400W	NAV-E-70W-I
Power	70W	150W	250W	400W	70W
Current	1A	1.80A	3A	4.40A	0.98A
Finish	Coated	Coated	Coated	Coated	Coated
Lamp base	E27	E40	E40	E40	E27
Lumen	6300lm	17000lm	31600lm	56500lm	5800lm

LAMPS  
LIGHTING

MERCURY VAPOUR LAMPS

Elliptical



Code	HQL-80W	HQL-125W	HQL-250W	HQL-400W
Power	80W	125W	250W	400W
Current	0.80A	1.2A	2.1A	3.2A
Finish	Coated	Coated	Coated	Coated
Lamp base	E27	E27	E40	E40
Lumen	4000lm	6800lm	14000lm	24000lm

MERCURY BLENDED LAMPS

Elliptical



Code	HWL-160	HWL-250	HWL-500
Power	160W	250W	500W
Current	0.80A	1.20A	2.40A
Finish	Coated	Coated	Coated
Lamp base	E27	E40	E40
Lumen	3100lm	5600lm	14000lm

HID LAMPS - ACDC



Watts	Metal Halide (MH) Code				High pressure Sodium (HPS) Code		
	G12	Rx7s	Tubular	Elliptical	ST (Rx7s)	Tubular	Elliptical
50W	G12-50	-	-	-	-	-	-
70W	G12-70	MD-70	-	MTE-70-E27	ST-70	SD-70-E27 SD-70I-E27†	-
100W	-	-	-	MTE-100-E27	-	SD-100-*	-
150W	G12-150	MD-150	-	MTE-150-E27	ST-150	SD-150-E27	SE-150-E40
250W	-	-	MT-250-E40	MTE-250-E40	-	SD-250-E40	SE-250-E40
400W	-	-	MT-400-E40	MTE-400-E40	-	SD-400-E40	SE-400-E40
1000W	-	-	MT-1000-E40	MTE-1000-E40	-	SD-1000-E40	SE-1000-E40

\*Add base to code: E27 or E40

†High pressure sodium with internal igniter

Colour

150W	-	MD-150-*	-	-	-	-	-
400W	-	-	JLZ400W-BL	-	-	-	-

\* Add colour to code: ● BL (Blue), ● GN (Green)

QE	Mercury Vapour			
	QE-80	80W	3240lm	E27
	QE-250	250W	11025lm	E40
QE-400	400W	21000lm	E40	
QB	Mercury Vapour Blended			
	QB-160	160W	3100lm	E27
	QB-250	250W	5600lm	E40
	QB-500	500W	14000lm	E40
MD-(HQI-TS); MT-(HQI-T); MTE-(HQI); SD-(NAV-TS); SE-(NAVE); QE-(HQL); QB-(Mercury Vapour blended lamps)				
Expected lamp life 5000hrs; Lamps to be used with relevant control gear.				

# LED FLOODLIGHTS

**2 Year Warranty!**



Optional

**LED Economical Floodlights - IP65** | Supply Voltage: 220-240VAC | Beam Angle: 120° | With 3 x MOV's | SMD Chipsets

Code	Code With Day/Night Sensor <sup>NEW</sup>	Wattage	Lumens	Size (mm)
FL-10W-*	DNFL-10W-CW	10W	800lm	95 x 85 x 25
FL-20W-*	DNFL-20W-CW	20W	1600lm	120 x 100 x 30
FL-30W-*	DNFL-30W-CW	30W	2400lm	150 x 120 x 30
FL-50W-*	DNFL-50W-CW	50W	4000lm	200 x 150 x 30
FL-100W-CW	DNFL-100W-CW	100W	8000lm	250 x 180 x 30
FL-150W-CW	DNFL-150W-CW	150W	12000lm	270 x 210 x 34
FL-200W-*	DNFL-200W-CW	200W	16000lm	250 x 300 x 40

\*Add colour to code: ○ WW (Warm White) 3000K, ○ CW (Cool White) 5500-6000K

FL-400W-CW	-	400W	32000lm	490 x 370 x 50
------------	---	------	---------	----------------

\*Add colour to code: ○ CW (Cool White) 4200K, ○ DL (Daylight) 6000K

**3 Year Warranty!**



**LED General Floodlights - IP65** | Supply Voltage: 120-265VAC | Beam Angle 120° | SMD Chipsets | Designed for general applications

Code	Wattage	Lumens	Size (mm)	Spare Driver
GY225TG-10W-*	10W	900lm	125 x 120 x 45	DRV-GY225TG-10W
GY225TG-20W-*	20W	1800lm	200 x 180 x 45	DRV-GY225TG-20W
GY225TG-30W-*	30W	2700lm	200 x 225 x 50	DRV-GY225TG-30W
GY290TG-40W-*	40W	3600lm	270 x 280 x 80	DRV-GY290TG-40W
GY290TG-50W-*	50W	4500lm	270 x 280 x 80	DRV-GY290TG-50W
GY370FG-60W-*	60W	5400lm	316 x 235 x 65	DRV-GY370FG-60W
GY370FG-70W-*	70W	6300lm	375 x 290 x 75	DRV-GY370FG-70W
GY470TG-80W-*	80W	7100lm	375 x 290 x 75	DRV-GY470TG-80W
GY470TG-100W-*	100W	9000lm	375 x 290 x 75	DRV-GY470TG-100W
GY490TG-150W-*	150W	14500lm	455 x 330 x 95	DRV-GY490TG-150W
GY490TG-200W-*	200W	18000lm	455 x 330 x 95	DRV-GY490TG-200W

\*Add colour to code: ○ WW (Warm White) 3000K, ○ CW (Cool White) 5500-6000K

**LED High Quality Floodlights - IP65** | Supply Voltage: 85-265VAC | LED Floodlights above 100W are supplied with Meanwell Drivers | Designed for industrial applications

Code	Wattage	Lumens	Size (mm)	Spare Driver
GY480TG-100W-*	100W	9000lm	350 x 300 x 70	DRV-GY480TG-100W
GY480TG-150W-*	150W	18000lm	450 x 348 x 60	DRV-GY480TG-150W
GY480TG-200W-*	200W	24000lm	450 x 348 x 60	DRV-GY480TG-200W
GY480TG-400W-*	400W	40000lm	620 x 500 x 125	DRV-GY480TG-400W
GY570FG-120W-*	120W	12000lm	593 x 285 x 93	DRV-GY570FG-120W
GY670S-150W-*	150W	15000lm	451 x 311 x 202	DRV-GY670S-150W
GY670S-180W-*	180W	18000lm	451 x 311 x 202	DRV-GY670S-180W
GY670S-200W-*	200W	20000lm	525 x 365 x 185	DRV-GY670S-200W
GY670S-320W-*	320W	32000lm	525 x 365 x 185	DRV-GY670S-320W
GY670S-400W-*	400W	40000lm	580 x 320 x 190	DRV-GY670S-400W

\*Add colour to code: ○ WW (Warm White) 3000K, ○ CW (Cool White) 5500-6000K

**LED Plastic Floodlights - IP65** | Supply Voltage: 220-240VAC | Stainless Steel Bracket

| Colour Temp: 5500K | Plastic / Stainless Steel | SMD Chipset | Also Available in DC

Code	Wattage	Lumens	Size (mm)
COS-FL10W-CW*	10W	900lm	128 x 112 x 31
COS-FL20W-CW*	20W	1800lm	170 x 150 x 40
COS-FL30W-CW*	30W	2250lm	230 x 190 x 40
COS-FL50W-CW*	50W	4500lm	300 x 245 x 40
COS-FL100W-CW*	100W	8000lm	390 x 290 x 36

\*Add Voltage to code: /12VDC, /24VDC

**IDEAL FOR COASTAL REGIONS**

**2 Year Warranty!**



## LED FLOODLIGHTS



10W, 30W, 50W 100W

**LED Slimline Floodlights - IP65** | Supply Voltage: 85-265VAC | Die-Cast Aluminium | Beam Angle: 110°

Code	Wattage	Lumens	Size (mm)
RW-A010-*	10W	650lm	170 x 200 x 50
RW-A030-*	30W	1950lm	250 x 325 x 80
RW-A050-*	50W	3250lm	320 x 385 x 100
RW-A100-*	100W	6500lm	400 x 480 x 140

\*Add Colour to Code: ○ WW (Warm White) 3000K, ○ CW (Cool White) 5500-6000K

5 Year Warranty!



**Sky 2.0 Floodlights - IP65** | Input Voltage: 230VAC | Driver on Board | Beam Angle: 90° | Removable cable entry for easy installation | Cable not supplied | SMD Chipset

Code	Wattage	Lumens	Size (mm)
YT-NP-FL16-10W-*	10W	900lm	90 x 65 x 45
YT-NP-FL16-20W-*	20W	1800lm	100 x 70 x 45
YT-NP-FL16-30W-*	30W	2700lm	136 x 95 x 45
YT-NP-FL16-50W-*	50W	4500lm	180 x 126 x 37
YT-NP-FL16-100W-*	100W	9000lm	210 x 147 x 37

\*Add Colour to Code: ○ WW (Warm White) 3000K, ○ CW (Cool White) 5500-6000K

5 Year Warranty!

NEW



**3CCT Adjustable Floodlight IP65** - 190-260VAC | 120° Beam Angle | 10kV Surge Protection | Colour Temp can be adjusted 3000K - 4000K - 6000K

Code	Wattage	Lumens	Size (mm)
GY-CCT-50W	50W	6000lm	
GY-CCT-100W	100W	12000lm	
GY-CCT-150W	150W	18000lm	
GY-CCT-200W	200W	24000lm	

**DC Floodlights - IP65** | Input Voltage: DC | Beam Angle: 110° | Other DC Voltages available on request



FL1

FL3

Code	Wattage	Lumens	Size (mm)	Spare Driver
FL1-DC-10W-*	10W	800lm	90 x 80 x 24	DRV-FL1-DC-10W-*
FL3-DC-20W-*	20W	1600lm	115 x 110 x 24	DRV-FL3-DC-20W-*
FL3-DC-30W-*	30W	2400lm	150 x 110 x 24	DRV-FL3-DC-30W-*
FL3-DC-50W-*	50W	4000lm	195 x 150 x 30	DRV-FL3-DC-50W-*
*FL3-AC-20W-CW32VAC	20W	1600lm	225 x 185 x 160	DRV-FL3-AC-20W
*FL3-AC-30W-CW32VAC	30W	2400lm	225 x 185 x 160	DRV-FL3-AC-30W

\*Add Colour to Code: ○ WW (Warm White), ○ CW (Cool White)

\*Add Volts to Code: 12VDC, 24VDC, 48VDC | \*32VAC only



**Colour Floodlights** - Input Voltage: 230VAC | Beam Angle 110° | Ideal for decorative applications

Code	Wattage	Lumens	Size (mm)	Spare Driver
FLC-20W-*	20W	Dependant on colour	125 x 120 x 25	DRV-GY225TG-20W
FLC-30W-*	30W		185 x 180 x 25	DRV-GY225TG-30W
FLC-50W-*	50W		225 x 220 x 30	DRV-GY290TG-50W
FLC-100W-*	100W		375 x 290 x 75	DRV-GY470TG-100W
FLC-20W-UV	20W	1600lm	130 x 120 x 40	-

\*Add Colour to Code: ● R (Red), ● GN (Green), ● BL (Blue), ● Y (Yellow)



**Colour Changing Floodlights - IP65** | Input Voltage: 100-240VAC | Beam Angle 110° | 16 Million Colours + White

Code	Wattage	Lumens	Size (mm)	Spare Driver
FLC-20W-RGBW	20W	Dependant on colour	124 x 100 x 24	DRV-FLC-20W-RGBW
FLC-30W-RGBW	30W		159 x 122 x 26	DRV-FLC-30W-RGBW
FLC-50W-RGBW	50W		205 x 160 x 34	DRV-FLC-50W-RGBW
FLC-100W-RGBW	100W		270 x 210 x 34	DRV-FLC-100W-RGBW

c/w Remote Control to Change Colour RGBW ●●●○

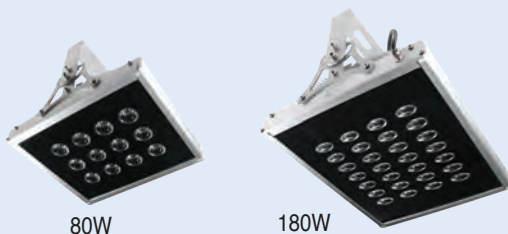

80W

180W

**LED Narrow Beam Floodlights - IP65** | Input Voltage: 90-265VAC | Beam Angle: 10° | Colour Temp.: 6500K

Code	Wattage	Lumens	Size (mm)
SS-FL-80W	80W	7000lm	240 x 285 x 150
SS-FL-100W	100W	8400lm	300 x 285 x 150
SS-FL-120W	120W	10700lm	360 x 285 x 150
SS-FL-180W	180W	15700lm	540 x 285 x 150

## LED FLOODLIGHTS



**Rhombberg LED Floodlight - IP65** | Input Voltage: 230VAC

Code	Wattage	Lumens	Size (mm)
JM-LED-54W-CW	40W	4000lm	315 x 235 x 125

**1 Year Warranty!**



**Economy LED Flood Light** - Input Voltage: 230VAC | 6500K

Code	Wattage	Lumens	Size (mm)
ECHO-50-CW	50W	2600lm	250 x 130 x 50

**NEW**

## LED SPORT FLOODLIGHTS



FA-480

FA-720

FA-960

**LED Stadium Floodlights - IP65** | Input Voltage: 100-277VAC | Phillips LumiLEDs | Meanwell Driver | Colour Temp: 5500K | Ideal for Stadium Lighting

Code	Wattage	Lumens	Beam Angle	Size (mm)
FA-480-30	480W	52 200lm	30°	630 x 500 x 285
FA-720-30	720W	82 800lm	30°	885 x 500 x 285
FA-960-30	960W	110 400lm	30°	1145 x 500 x 285
FA-480-60X100	480W	52 200lm	60° x 100°	630 x 500 x 285
FA-720-60X100	720W	82 800lm	60° x 100°	885 x 500 x 285
FA-960-60X100	960W	110 400lm	60° x 100°	1145 x 500 x 285
FB-480-120	480W	60 000lm	120°	630 x 500 x 285
FB-720-120	720W	90 000lm	120°	885 x 500 x 285
FB-960-120	960W	120 000lm	120°	1145 x 500 x 285

### Accessories

Code	Description
FA-AIM	Laser Aiming device for LED Floodlight

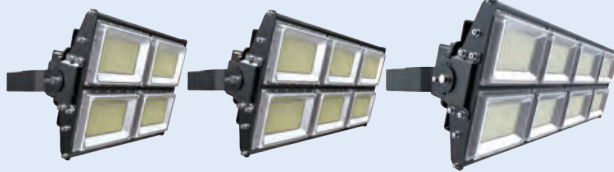

FB-480

FB-720

FB-960

**5 Year Warranty!**



FA-AIM



**G2 Stadium Floodlights - IP66** | Input Voltage: 100-277VAC | 5500K | CRI >70 | 30°/45°/80° (150lm/W) | 15° (130lm/W) | c/w 10kV SPD | Operating Temp.: -40°C to 50°C | Remote Gear | Glare Control Lens | Applications: Stadiums, Arenas, Golf Courses, Courts | Available in 15°, 30°, 45°, 80° Beam Angles

Code	Wattage	Lumens	Size (mm)
ST-RSL-500W-*	500W	75 000lm	Ø495 x 236
ST-RSL-600W-*	600W	90 000lm	Ø495 x 236
ST-RSL-800W-*	800W	120 000lm	Ø495 x 236
ST-RSL-1000W-*	1000W	150 000lm	Ø495 x 236
ST-RSL-1200W-*	1200W	180 000lm	Ø495 x 236

\* Add Beam Angle to Code: **15** (15°), **30** (30°), **45** (45°), **80** (80°)



**LED Asymmetrical Floodlights - IP65** | Input Voltage: 170-240VAC | Colour Temperature: 6500K | Concentrated Beam Angle | Suitable for Sports & Area Lighting

Code	Wattage	Lumens	Size (mm)
NP-FL03-80W	80W	6400lm	255 x 87 x 290
NP-FL03-100W	100W	8000lm	255 x 87 x 290

**LED Stadia Floodlight - IP66** | Input Voltage: 100-277VAC | 140lm/W | RA80 | PF > 0.9 | Beam Angles 30° / 60° / 90° / 80° x 140° | Colour Temperature: 6000K | Ideal for Highmast lighting & Sport facilities

Code	Wattage	Lumens	Size (mm)
YT-NP-FL07-75W-*	75W	10125lm	365 x 310 x 60
YT-NP-FL07-100W-*	100W	13500lm	365 x 310 x 60
YT-NP-FL07-150W-*	150W	20250lm	365 x 365 x 60
YT-NP-FL07-200W-*	200W	27000lm	365 x 420 x 60
YT-NP-FL07-300W-*	300W	40500lm	387 x 590 x 63
YT-NP-FL07-400W-*	400W	54000lm	387 x 590 x 63

\* Add Beam Angle to Code: **N**(30°), **M**(60°), **W**(90°), **MW**(80° x 140°). Only Stocking **W**(90°) other Beam Angles on Request only.

**5 Year Warranty!**



75-100W

150-200W

200-400W



## LED SPORT FLOODLIGHTS



**Dragon Stadium Floodlight - IP66** - Input Voltage: 100-277VAC | 5700K | 150lm/W | L70B10 50000hrs | 360° Rotatable Module | Tempered Glass, PMMA Lens | Ideal for Sport fields & Stadiums

Code	Wattage	Lumens	Beam Angle	Size (mm)
B-240W-30-DL	240W	36 000lm	30°	745 x 332 x 172
B-500W-30-DL	500W	75 000lm	30°	745 x 594 x 172
B-800W-30-DL	800W	120 000lm	30°	745 x 817 x 172
B-1000W-40-30-DL	1000W	150 000lm	30°	911 x 1125 x 181
B-1500W-40-30-DL	1500W	225 000lm	30°	1139 x 1125 x 181



**5 Year Warranty!**

NEW

## LED MODULAR FLOODLIGHTS

**5 Year Warranty!**



**LED Adjustable Floodlights - IP65** Input Voltage: 230VAC | Colour Temp: 6500K | Modular and adjustable | Suitable for Sports Fields, Warehouses, Gymnasiums, Workshops, Gas Stations, Toll Stations, Parking Areas, etc.

Code	Wattage	Lumens	Size (mm)
HBB-HD-C1	50W	7000lm	310 x 85 x 120
HBB-HD-C2	100W	14000lm	310 x 176 x 120
HBB-HD-C3	150W	21000lm	310 x 267 x 120
HBB-HD-C4	200W	28000lm	310 x 360 x 120
HBB-HD-C6	300W	42000lm	310 x 542 x 120
HBB-HD-C8	400W	56000lm	310 x 726 x 120
HBB-HD-C10	500W	70000lm	310 x 910 x 120
HBB-HD-C12	600W	84000lm	610 x 542 x 120
HBB-HD-C16	800W	112000lm	610 x 726 x 120
HBB-HD-C20	1000W	140000lm	610 x 910 x 120

**LED Adjustable Floodlights - IP65** | Input Voltage: 85-265VAC | Colour Temp.: 6500K | LED Modules are Adjustable | Working Temperature -40°C - +60°C

Code	Wattage	Lumens	Size (mm)
CE33-DL	40W	4200lm	238 x 102 x 178
CE37-DL	80W	8400lm	238 x 102 x 178
CE46-DL	160W	6800lm	425 x 219 x 227

**Modular LED Floodlight - IP66** | Input Voltage: 230VAC | Beam Angle 110° | Colour Temp: 6500K | Driver on board | Modular design to allow more fittings to be added horizontally | Optional bracket required when adding fittings.



Code	Wattage	Lumens	Size (mm)
YT-TG-09-DOB	50W	4500lm	240 x 115 x 35

### Accessories

Code	Description
YT-TG-BK	Bracket for adding additional fittings ( 2 Per Pack)

## LED MOTION SENSOR FLOODLIGHTS



**LED PIR Motion Sensor Floodlight - IP65** | Input Voltage: 230VAC

Code	Wattage	Lumens	Size (mm)
PR225TG-10W-*	10W	800lm	135 x 90 x 25
PR225TG-20W-*	20W	1600lm	175 x 125 x 25
PR225TG-30W-*	30W	2400lm	235 x 185 x 25
PR225TG-50W-*	50W	4000lm	275 x 225 x 30

\*Add colour to code: ○ **CW** (Cool White) 5500-6000K, ○ **WW** (Warm White) 3000K

**NEW**



**LED PIR Motion Sensor Floodlight - IP54** | Input Voltage: 230VAC | Colour Temperature: 6500K | ABS Body | PC Diffuser | PIR Sensor | Adjustable Head

WP05-10W-DL	10W	800lm	152 x 140 x 230
WP05-20W-DL	20W	1600lm	134 x 350 x 236

**Aluminium Adjustable Spot Head with PIR - IP54** | Input Voltage: 230VAC | Colour Temperature: 6500K | Robust Aluminium Body | Time Adjustable 3s - 7min | Motion Sensor 140° | 20 - 20 000 lux | Max 12m Sensing

S1707A-20	20W	1600lm	283 x 189 x 130
-----------	-----	--------	-----------------

**NEW**



**LED Floodlight Microwave Motion & Day/Night Sensor - IP65** | Input Voltage: 230VAC | Material: Plastic

PIR-N-10W-*	10W	800lm	150 x 116 x 36
PIR-N-20W-*	20W	1600lm	150 x 116 x 36
PIR-N-30W-*	30W	2400lm	170 x 130 x 36
PIR-N-50W-*	50W	4000lm	230 x 170 x 36
PIR-N-100W-*	100W	8000lm	390 x 290 x 36

\*Add colour to code: ○ **CW** (Cool White) 5500-6000K, ○ **WW** (Warm White) 3000K

**NEW**

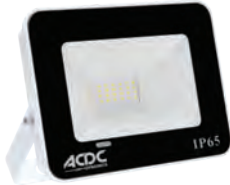

**LED Day/Night Sensor Floodlight - IP65** | Input Voltage: 230VAC | Material: Plastic

DN-N-10W-*	10W	800lm	150 x 110 x 36
DN-N-20W-*	20W	1600lm	150 x 110 x 36
DN-N-30W-*	30W	2400lm	170 x 130 x 36
DN-N-50W-*	50W	4000lm	230 x 170 x 36
DN-N-100W-*	100W	8000lm	390 x 290 x 36

\*Add colour to code: ○ **CW** (Cool White) 5500-6000K, ○ **WW** (Warm White) 3000K

## SMART SKY LED FLOODLIGHTS



WF-FL17-20W-CW/WW

WF-FL17-20W-RGBW

Input Voltage: 230VAC | 110° Beam Angle

Code	Wattage	Lumens	Size (mm)
WF-FL17-20W-CW/WW	20W	2000lm	162 x 36 x 144
WF-FL17-20W-RGBW	20W	2000lm	162 x 36 x 144



WiFi Control



App Control



Remote Switching



Dimmable



Set Timers & Schedules



Scenes Control



Colour Temp. Adjustable



Music



Colour Temp. Adjustable



Colour RGBW Adjustable

## LED FLOODLIGHT ACCESSORIES



**Garden Spike**

Code	Description
GY-SPIKE	Garden spike for ALL LED Floodlights up to 50 Watts

## LED SPOT LIGHT IP65



Input Voltage: 230VAC

Code	Wattage	Lumens	Size (mm)
ZL-L3222P-*	28W	2380lm	260 x 272 x 86
ZL-L3222L-*	30W	2300lm	260 x 272 x 86
ZL-L3223A-CW	80W	1100lm	190 x 278 x 86
NLG08-08A-*	24W	2000lm	230 x 354
GY290TS-30W-*	30W	2400lm	290 x 236 x 206
GY290TS-40W-*	40W	3200lm	290 x 236 x 206
GY290TS-50W-*	50W	4000lm	290 x 236 x 206

\*Add colour to code: ○ CW (Cool White) 5500-6000K, ○ WW (Warm White) 3000K

## LED WORK LIGHTS IP65



Floor Standing Work Light - Input Voltage: 230VAC | Colour Temp. 6500K  
120° Beam Angle

Code	Wattage	Lumens	Size (mm)
NLG08-08C-*	24W	2400lm	410 x 354
WS225TG-20W	20W	2000lm	250 x 190 x 160
WS225TG-30W	30W	3000lm	260 x 220 x 160
WS225TG-50W	50W	5000lm	330 x 270 x 180
WS225TG-100W	100W	8450lm	400 x 350 x 230

Tripod Work Lights - Input Voltage: 230VAC | Colour Temp. 6500K | c/w 2 meter mains cable and plug



Code	Wattage	Lumens	Size (mm)	Spare Stand
NLG08-08B	24W	2400lm	1650 x 295	-
NLG08-08B2	2 x 24W	4800lm	1650 x 600	-
WP225T1-20W-*	20W	2000lm	1650 x 500	WP225T1-STAND
WP225T1-30W-*	30W	3000lm	1650 x 295	WP225T1-STAND
WP225T1-50W-*	50W	5000lm	1650 x 295	WP225T1-STAND
WP225T2-20W-*	2 x 20W	4000lm	1650 x 500	WP225T2-STAND
WP225T2-30W-*	2 x 30W	6000lm	1650 x 600	WP225T2-STAND
WP225T2-50W-*	2 x 50W	10000lm	1650 x 500	WP225T2-STAND

\*For Low Voltage add: 12VDC, 24VDC

## PORTABLE LIGHTS C/W BATTERY



Rechargeable | c/w charger & car charger | Material: ABS Plastic | IP65

Code	Wattage	Battery Type	Battery Life	Size	Colour Temp
SP-W806A	180LEDs (13W)	12V, 7Ah (Lead Acid)	3hrs	450 x 300	DL (6000K)

Rechargeable | c/w charger & car charger | Material: Die-Cast Aluminium | IP65

PFL-5W-*	5W	7.4V, 2200mAh (Li)	3hrs	145 x 166 x 255	DL / RGB
PFL-10W-*	10W	7.4V, 2200mAh (Li)	3hrs	145 x 166 x 255	DL / RGB
PFL-20W-*	20W	14.8V, 4400mAh (Li)	3hrs	215 x 185 x 295	DL / RGB

\*Add colour to code: ○ DL (Daylight) 6500K, ●●● RGB (Colour Changing)



LED Work Light - Operating Mode: High - Low - SOS - Off | USB Input Charging | USB Output for mobile device charging | Material: Nylon | IP44

Code	Watts	Lumens	Battery Type	Battery Life	Size	Colour Temp
WL03-COB-10W	10W	750lm	7.4V, 2 x 2200mAh (Li)	3hrs High / 10hrs Low	173 x 127 x 45	DL (6000K)
WL03-COB-20W	20W	1800lm	11.1V, 3 x 2000mAh (Li)	3hrs High / 8hrs Low	173 x 127 x 45	DL (6000K)

## PORTABLE LIGHTS C/W BATTERY



**CFL - IP65** | Lamps included | Rechargeable | Material: Plastic

Code	Wattage	Battery Type	Working Time	Colour Temp
<b>E84W/24A</b>	2 x 42W (CFL)	24Ah Sealed Lead acid	1 lamp:7hrs/2 lamp:3.5hrs	DL (6000K)
<b>E84W/24A-E</b>	2 x 42W (CFL)	24Ah Sealed Lead acid	1 lamp:7hrs/2 lamp:3.5hrs	DL (6000K)

**LED - IP65** | Lamps included | Rechargeable | Material: Aluminium

<b>E2410-30</b>	30W (LED)	10Ah Li-Ion	7hrs	DL (6000K)
-----------------	-----------	-------------	------	------------

**Explosion Proof - IP65** | c/w wheels & 2 light levels selectable | Material: Aluminium Alloy |

Ex de II C T6

**FLP**

<b>BW3210</b>	30W (LED)	12Ah Sealed Lead acid	High: 16hrs / Low: 36hrs	DL (6000K)
---------------	-----------	-----------------------	--------------------------	------------



**AC & DC Work Light IP54** - AC Power 120-240VAC / DC Power 18-20V Battery Pack (include) | 2 Working Modes: 30% @ 900lm = 11hrs, and 100% @ 2500lm = 3hrs work time | Plastic Body + Steel Tripod | c/w 2m Power Cable | AC & Battery backup work light for fixed or remote work sites.

Code	Wattage	Lumens	Battery	Size (mm)	Colour
<b>WL10621-30</b>	AC - 45W DC - 25W	100lm/W	18.5V 4400mAh Li-ion	Ø670 x 1126 (open)	6500K

**LED Mobile Emergency Lighting in Case IP67** - Colour Temp: 6500K | c/w Built-In Charger | c/w Batteries | c/w Wheels for easy transportation

c/w Wheels



Code	5JG-RL9972	RLS512722-72W	RLS584433-144W
Lamp Power	36W	72W	144W
Lumen (High/Med/Low)	2100/1255/884lm	4000/2000/1500	8000/4000/2000
Total Weight	14.5kg	22kg	32kg
Battery Type	12V 10Ah Lithium	12V 24Ah	12V 33Ah
Working Time hrs	33hrs (low)/17hrs (med)/8hrs (high)	26hrs (low)/14hrs (med)/7hrs (high)	28hrs (low)/16hrs (med)/8hrs (high)
Charge Time	5.5hrs	6-8hrs	6-8hrs
Spare Battery Code	<b>RLS-963L-BAT</b>	<b>RLS512722-BAT</b>	<b>RLS584433-BAT</b>

## LED BILLBOARD LIGHTS IP65

**SOL2 SOLAR**

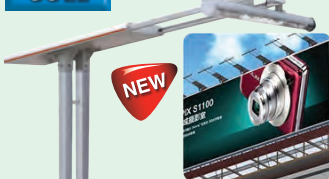

**Solar Billboard Floodlight** - Colour Temperature: 5500K | Working Hours: 4-6Hrs, 3-5Hrs (Rainy Day) | Charging Time: 6-8Hrs | Life PO4 Battery

Code	Solar Panel	Light Source	Lumen	Size (mm)	Weight (Kg)
<b>LFA-36W</b>	18V / 60W	36W CREE LED	3960lm	1155 x 480 x 185	35
<b>LFA-24W</b>	18V / 60W	24W CREE LED	2640lm	1155 x 355 x 185	23

**LED**

- 230VAC
- c/w arm



**LED Billboard Floodlight** - Input Voltage 230VAC | c/w Mounting Arm

Code	Power	Lumen	Size (mm)
<b>ZL-L3221PB*</b>	12W	1020lm	190 (wide) x 835 (incl. arm)
<b>ZL-L3221QB*</b>	20W	1700lm	190 (wide) x 835 (incl. arm)

\*Add colour to code: ○ **CW** (Cool White) 4200K, ○ **WW** (Warm White) 2700-3000K

## BILLBOARD LIGHT SERIES

Metal Halide  
230VAC  
Lamp excluded

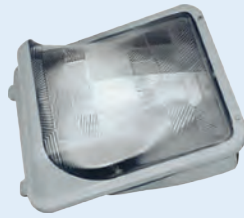
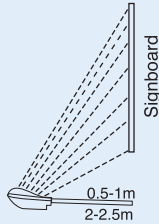

### Adjustable Arms for Mounting Floodlights

Powder coated black.  
Light fitting excluded.



Joints can rotate  
through 270°



Code	GG01	GG012	GG01-EMPTY	Code	JM-ZJ-01	JM-ZJ-02	JM-ZJ-03
Wattage	250W	400W	400W Max	Description	600mm fixed arm	1200mm hinged arm (2 x 600mm)	1800mm hinged arm (3 x 600mm)
Lamp Type	E40/ MTE-250	E40/ MTE-400	CFL/LED	Max Fitting Weight	32kg	14kg	14kg
<b>IP Rating</b>	<b>IP65</b>	<b>IP65</b>	<b>IP65</b>				

## LED WALL WASHER FLOODLIGHTS IP65

RGB  
16 Million  
Static Colour  
Shows



RGB  
Beam  
angle 25°



Single  
Colour



Code	LW-AL-300	LW-003-RGB	SL-T204*
Power	25W/3A	R:12, G:12, B:12 (36 x 1W)	24 x 1W (24W)
Lumen	371lm	371lm	2000-2300lm (White)
Size (mm)	300L x 145W x 225H	343L x 150W x 214H	330L x 160mm
Light Distance	20m	10m	10m
DMX Controller	<b>SRC-174</b>	Independent and <b>DMX512</b>	No DMX
Supply Volts	90-264VAC	100-240VAC	230VAC

\*Add colour to code: ● R (Red), ● GN (Green), ● BL (Blue), ● Y (Yellow), ○ PW (Pure White)



### RGB LED Wall Washer - 100-256VAC | • Beam Angle 30° | c/w wall brackets

Code	Size (mm)	LED Qty	LED Power	Total Power
LW-020-RGB	500 x 45 x 62	R:4 G:4 B:4	12 x 1W	15W
LW-021-RGB	850 x 45 x 62	R:8 G:8 B:8	24 x 1W	30W
LW-022-RGB	1000 x 45 x 62	R:12 G:12 B:12	36 x 1W	40W
LW-022-RGB-AUTO	1000 x 45 x 62	R:12 G:12 B:12	36 x 1W	40W



### LED Wall Washer IP66 - Input Voltage: 240VDC | High Strength Aluminium Housing + Tempered Glass | c/w Mounting Bracket

Code	Wattage	Colour	Beam Angle	Control	Size (mm)
ELI-LW-2626	15W	Cool White (4200K)	120°	Steady	1000 x 26 x 26
ELI-LW-3026	24W	RGB	30°	DMX 512	1000 x 30 x 26
ELI-LW-4226	36W	RGBW	15°	DMX 512	1000 x 30 x 26

Supply Voltage:  
230VAC

RGB

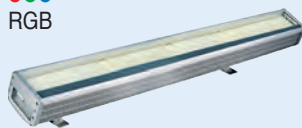

RGB

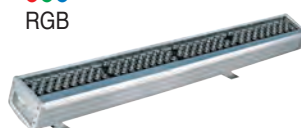

RGB

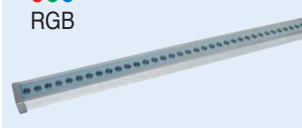

### Indoor IP20

RGB 110-240VAC  
Sound active, auto run mode, colour strobe, dimmer, colour mixing, colour water flow & chasing effects

Code	LW-008	LW-009	LW-024	LW-WF-F10-252
Power/max	1440 x 5mm LEDs (112W max)	144 x 1W (220W max)	36 x 1W (56W max)	252 x 10mm LEDs (50W max)
Lumen	1187lm	1482lm	1112lm	480lm
Size (mm)	1240L x 150W x 172H	1240L x 150W x 172H	1120L x 76W x 163H	1240L x 76W x 163H

Independent and DMX Mode Available beam angle 25°. DMX controller: **DMX-512**

## FLOODLIGHTS - INDUCTION IP65



Code	EDC*-DL	VF*-DL	JM-JN*
*Add watts to code	<b>80W, 100W</b>	<b>200W, 300W</b>	<b>80W, 120W, 200W</b>
lm/W	80lm	80lm	80lm
Colour Temp	5000-5500K	5000-5500K	6500K
Size (mm)	450 x 450 x 155	Ø430 x H350	440 x 410 x 140

2 Year warranty on all LED products, & 1 Year warranty on all products that carry batteries, unless otherwise specified. Warranty void if adequate surge protection is not installed on LED products. See page 149

## FLOODLIGHTS - ENERGY SAVING IP65

Lamp supplied: Daylight 6500K.  
For spare lamps, see page 20



DF-65CFL



DF-180CFL

Energy Saving Floodlights - c/w lamp 230VAC

Code	Watts	Lamp Holder	Light Fitting	Lamp Code	Size (mm)
DF-30CFL	30W	E27	-	-	270 x 202 x 132
DF-45CFL	45W	E40	F2012	-	395 x 224 x 165
DF-065CFL	65W	E40	-	ESL42-65-E40-D	410 x 300 x 139
DF-105CFL	105W	E40	-	-	410 x 300 x 139
DF-125CFL	125W	E40	FL1028	ESL42-125-E40-D	580 x 475 x 168

Lamp supplied: Daylight 6500K

DF-150CFL	150W	E40	FL1028	ESL42-150-E40-D	580 x 475 x 168
DF-180CFL	180W	E40	FL1028	ESL42-180-E40-D	580 x 475 x 168
DF-200CFL	200W	E40	FL1028	ESL42-200-E40-D	580 x 475 x 168

Energy Saving Floodlights - Lamp to be ordered separately. See page 18-19



LD3001-2X26W LD3001-4X26W LD3001-51

Code	Lamp Holder	Watts	Size(mm) H x W x D	Lamp Type
LD3001-2X26W	G24q3	2 x 26W	290 x 240 x 115	PLCE-26-CW
LD3001-4X26W	G24q3	4 x 26W	450 x 325 x 130	PLCE-26-CW

Empty Floodlights - Lamp to be ordered separately. See page 20.

LD3001-50	E27	70W	290 x 240 x 115	ESL42-45-E27-S-M
LD3001-51	E40	150W	400 x 325 x 130	ESL42-65-E40-S-M
LD3001-52	E40	400W	400 x 420 x 170	ESL42-150-E40-D

## PLASTIC ENERGY SAVING FLOODLIGHTS

Supply Voltage  
230VAC  
Lamps Included  
Cool White 4000K



Lamps excluded



Electronic Ballast



Electronic Ballast



Electronic Ballast

Code (c/w lamp)	BL070	FLN001-65	FL1063-18	FL1063-26	FL1063-42
Wattage/Lamp	2 x 23W	2 x 65W	2 x 18W	2 x 26W	2 x 42W
Spare Lamp	FE35-26-E27	ESL42-65-E27-D	PLC-18-CW	PLC-26-CW	PLCE-42-CW
IP Rating	IP65	IP65	IP65	IP65	IP65
Material	High Strength Plastic	Plastic	Plastic	Plastic	Plastic
Size (mm)	260 x 260 x 105	338 x 430 x 118	315 x 235 x 125	315 x 235 x 125	390 x 325 x 135

## FLOODLIGHTS - HID

High Pressure Sodium Floodlight IP55

Metal Halide Floodlight IP55

Mercury Vapour Floodlight IP55

Watts	High Pressure Sodium Floodlight IP55		Lamps	Lamp Holder	Metal Halide Floodlight IP55		Lamps	Lamp Holder	Mercury Vapour Floodlight IP55		Lamps	Lamp Holder
	Code Symmetrical	Code Asymmetrical			Code Symmetrical	Code Asymmetrical			Code Symmetrical	Code Asymmetrical		
70W	DF-070HPS-S	DF-070HPS-A	ST-70	RX7s	DF-070MH-S	DF-070MH-A	MD-70	Rx7s	-	-	-	-
125W	-	-	-	-	-	-	-	-	-	DF-125MV-A	QE-125	E27
150W	DF-150HPS-S	DF-150HPS-A	ST-150	RX7s	DF-150MH-S	DF-150MH-A	MD-150	Rx7s	-	-	-	-
250W	DF-250HPS-S	DF-250HPS-A	SD-250	E40	DF-250MH-S	DF-250MH-A	MT-250	E40	DF-250MV-S	DF-250MV-A	QE-250	E40
400W	DF-400HPS-S	DF-400HPS-A	SD-400	E40	DF-400MH-S	DF-400MH-A	MT-400	E40	DF-400MV-S	DF-400MV-A	QE-400	E40
1000W	DF-1000HPS-S	DF-1000HPS-A	SD-1000	E40	DF-1000MH-S	DF-1000MH-A	MTE-1000	E40	-	-	-	-

For Metal Halide Blue Light 400W use lamp code JLZ400W-B ( See page 26)

Order Lamps separately see page 25-26



For 70W & 150W  
Asymmetrical



For 250W & 400W  
Symmetrical



For 250W & 400W  
Asymmetrical



For 1000W Asymmetrical  
(Supplied with Vossloh-Schwabe ballast)



For 1000W Symmetrical  
(Supplied with Vossloh-Schwabe ballast)

## FLOODLIGHTS - HID



### Metal Halide Plastic Floodlights IP65

Stainless Steel 304 Bracket. C/w control gear. Lamps excluded, see page 25-26.

Code	Lamp Holder	Watts	Size(mm) H x W x D	Lamp Type
LD3001-70	Rx7s	70W	290 x 240 x 115	MD-70
LD3001-150	Rx7s	150W	400 x 325 x 130	MD-150
LD3001-400	E40	450W	400 x 420 x 170	MT-400

## EMPTY FLOODLIGHTS

Supply Voltage  
230VAC  
IP55



Code	FL1061-ASY	NB1025 ASY	NB1029-RX7 ASY	F2010 ASY	NB1029-E27 SYM
Type	Asymmetrical	Asymmetrical	Asymmetrical	Asymmetrical	Symmetrical
Lamp Holder	E40	E40	Rx7s/118	E40	E27
Wattage	1000W	400W	70/150W	250/400W	70/150W
Size (mm)	650 x 550 x 205	410 x 420 x 145	230 x 350 x 85	435 x 410 x 158	230 x 350 x 85

Supply Voltage  
230VAC  
IP55



Code	NB1025 SYM	FL1061-SYM	FL1001	FL1002	FL1003	FL1028
Type	Symmetrical	Symmetrical	Symmetrical	Symmetrical	Symmetrical	Symmetrical
Lamp Holder	E40	E40	E27	E40	E40	E40
Wattage	400W	1000W	70/150W	250/400W	1000W	70/150W
Size (mm)	410 x 420 x 145	650 x 517 x 227	290 x 225 x 190	415 x 320 x 260	568 x 435 x 420	600 x 480 x 168

Supply Voltage  
230VAC



Code	FL1063-E40	FL1063-E27	F2011	F2012
Type	Symmetrical	Symmetrical	Symmetrical	Symmetrical
Lamp Holder	E40	2 x E27	E40	E40
Wattage	250/400W	70/150W	70/150W	70/150W
Size (mm)	390 x 325 x 135	315 x 235 x 125	345 x 240 x 180	395 x 224 x 165

## HIGH MAST & STADIUM HID FLOODLIGHTS



**Asymmetrical High Performance - IP66** Narrow beam reflector | Sports field lighting | High mast lighting | Security lighting | Area lighting | Airport aprons | Lamps Not Included - See page 25-26 for lamps

Code	Lamp Holder	Wattage	Size (mm)
AF-400*	E40	400	360 x 450 x 185

\*Add type of switchgear required to code: **MH** (Metal Halide), **HPS** (High Pressure Sodium)

**Stadium - IP65** High efficiency light output | Multiple optics - Beam angle adjustable | Perfect solution for stadium lighting designs | Lamps and control gear to be ordered separately

Code	Head Piece	Lamp Holder	Wattage	Size (mm)	Lamp Code
YGTH-1000-A1		X528 (Double Ended)	1000	535 x 556 x 242	HQI-TS-1000
YGTH-2000-A1			2000		HQI-TS-2000(Long Arc)

**Control Gear IP65** - To be ordered Separately

Code	Gearbox	Description	Size (mm)
YGTH-GB-1000		230V, 1000W Gear tray in die-cast aluminium enclosure	295 x 250 x 156
YGTH-GB-2000		400V, 2000W Gear tray in die-cast aluminium enclosure	404 x 268 x 186.5



**LED HIGHBAYS IP65**

**5 Year Warranty!**



**Narrow Angle** - Supply voltage: 85-265VAC | Working Life: 50 000hrs | Power Factor: > 0.95 | Recommended Mounting Height +12m | Applicable for Workshops, Factories, Storage, Supermarkets, Shops

Code	Watts	Lumens	Colour Temp.	Beam Angle	Dimensions	Weight
LQ-ILH-200	200W	20000lm	6000K	60°	Ø367 x 459	11kg
LQ-ILH-300	300W	30000lm	6000K	60°	Ø367 x 470	11,5kg
LQ-ILH-400	400W	40000lm	6000K	60°	Ø367 x 497	12kg

- WW - 2700K
- CW - 4200K
- DL - 6000K



**FLP**



**Explosion Proof Light** - Supply Voltage: 85-265VAC | 120° Beam Angle.

Code	* Add Watts to Code	Luminous Efficiency	Size (mm)	*Add Colour to Code
SEM-HG-**-*	50W, 70W, 100W, 120W	100lm/W	Ø295 x 164	WW / CW / DL

- WW - 2700K
- CW - 4200K
- DL - 6000K



**Weatherproof Light** - Supply Voltage: 85-265VAC | 120° Beam Angle.

Code	* Add Watts to Code	Luminous Efficiency	Size (mm)	*Add Colour to Code
JR-GK10-**-*	50W, 70W, 100W, 120W	100lm/W	Ø295 x 164	WW / CW / DL

**LED High Bays**

Recommended Mounting Height 4-10m  
 • Supply Volts: 100-240VAC  
 • CRI: 75(cw), 80 (ww)  
 • Working Temp: -40-65°C  
 • Aluminium Reflectors available in two Beam Angles  
 • High Quality Meanwell Drivers  
 Please note that LED Head and Reflectors are to be ordered separately!

**3 Year Warranty!**

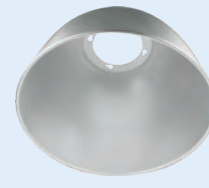

Ø 410mm

Ø 500mm

Complete Assembled Fitting

Wattage	Lumen	LED Head	Reflector 120°	Reflector 45-60°	Weight Inc.Ref
50W	4750lm	HB-LED-50W-*	HB-AL120-50W	HB-AL4560	4.1kg
100W	9500lm	HB-LED-100W-*	HB-AL120L		6.1kg
120W	11400lm	HB-LED-120W-*			6.1kg
150W	14250lm	HB-LED-150W-CW	HB-AL120L		8.3kg
200W	19000lm	HB-LED-200W-*			7.2kg

\*Add colour to code: ○ CW (Cool White) 4200K, ○ WW (Warm White) 3000K.

**3 Year Warranty!**

**NEW**



**High Power LED Highbays** - Supply voltage: 85 - 265VAC | Colour Temp: 4000K | CRI > 80 | Working Temp: -25°C to +60°C | Bridgelux Chipset

Code 45-60° Reflector	Code 120° Reflector	Watts	Lumens	Size
HB-L4560D-30W-CW	HB-L120D-30W-CW	30W	2850lm	Ø410 x 500
HB-L4560D-50W-CW	HB-L120D-50W-CW	50W	4750lm	Ø410 x 500
HB-L4560D-100W-CW	HB-L120D-100W-CW	100W	9500lm	Ø410 x 510
HB-L4560D-150W-CW	HB-L120D-150W-CW	150W	14250lm	Ø480 x 620
HB-L4560D-200W-CW	HB-L120D-200W-CW	200W	19000lm	Ø480 x 650

2 Year warranty on all LED products, & 1 Year warranty on all products that carry batteries, unless otherwise specified. Warranty void if adequate surge protection is not installed on LED products. See page 149



## LED HIGH BAYS

**5 Year Warranty!**

**NEW**



GY730



GY730-SEN-PIR

**UFO Type 120° Beam Angle - IP65** | Supply Voltage: 100-265VAC | Colour Temp: 6000K | Beam Angle 110° | 0-10V Dimmable | CRI>80 | Die-Cast Aluminium with Acrylic Lens | Plug & Play Compatibility to allow control options

Code	Wattage	Lumens	Size (mm)
GY730-100-DL	100W	15000lm	Ø253 x 194
GY730-150-DL	150W	22500lm	Ø308 x 194
GY730-200-DL	200W	30000lm	Ø354 x 194

### Optional Accessories

Code	Description
GY730-SEN-PIR	Plug and Play PIR Sensor
GY730-SEN-M	Plug and Play Microwave Sensor
GY730-SEN-BT	Plug and Play Bluetooth Module
GY730-SEN-REM	Remote Control for GY730-SEN-M

**3 Year Warranty!**

**150lm/W**



**UFO Type 120° Beam Angle - IP65** | Supply Voltage: 100-265VAC | Working Conditions: -40°- 55°C | Working Life: 50 000hrs | CRI > 80 | Power Factor: > 0.95

Code	Wattage	Lumens	Size (mm)
GY630-100-*	100W	15000lm	Ø247 x 90
GY630-150-*	150W	22500lm	Ø256 x 90
GY630-200-*	200W	30000lm	Ø270 x 95

\*Add colour to code: ○ CW (Cool White) 4000-4200K or ○ DL (Day Light) 6000K

**5 Year Warranty!**



**UFO Type 90° Beam Angle - IP65** | Supply Voltage: 100-240VAC | Working Conditions: -40°- 55°C | Working Life: 50 000hrs | Colour Temp: 6000K | CRI > 80 | Power Factor: > 0.95

Code	Wattage	Lumens	Size (mm)
GY530-120	120W	15000lm	Ø366 x 194
GY530-150	150W	18500lm	Ø366 x 194
GY530-200	200W	24000lm	Ø366 x 194

**2 Year Warranty!**



**DOB LED Highbay - IP65** | Supply Voltage: 220 -240VAC | Driver on board (DOB) | 120° Beam Angle | CRI 70 | Die-Cast Aluminium with Acrylic lens

Code	Wattage	Lumens	Size (mm)
GY-DOB-100W -*	100W	8000lm	Ø245 x 102
GY-DOB-150W -*	150W	12000lm	Ø280 x 103
GY-DOB-200W -*	200W	16000lm	Ø330 x 104

\*Add colour to code: ○ CW (Cool White) 4200K or ○ DL (Day Light) 6000K

**5 Year Warranty!**

**NEW**

**150lm/W**



**Orion Highbay - IP65** Input Voltage: 220-240VAC | 150lm/W | Colour Temperature 5000K | 1 - 10V Dimmable | Supplied with 120° Lens, Interchangeable lenses Available | Adaptable Reflectors Available

Code	Wattage	Lumens	Size (mm)
BT-ON100W-UV	100W	15000lm	Ø245 x 184
BT-ON150W-UV	150W	22500lm	Ø280 x 202
BT-ON200W-UV	200W	30000lm	Ø300 x 207

### Optional Accessories

Code	Description
BT-ON-LENS-60	60° Fresnel Lens
BT-ON-LENS-90	90° Fresnel Lens
BT-ON-REF-60	60° Aluminium Reflector
BT-ON-REF-90	90° Aluminium Reflector
BT-ON-REF-70	70° Acrylic Reflector



60°/90° Lens



60° Reflector



90° Reflector



70° Reflector

**LED HIGHBAYS**



GY830-A-DL

**Selectable Highbay - IP65** Supply Voltage: 220-240VAC | 90° Beam Angle | Colour Temperature: Selectable 3k, 4K, 5K | Power: Selectable 100,150, 200W | 0-10V Dimming Plug and Play Modules for added functions.

Code	Wattage	Lumens	Size (mm)
GY830-A-DL	100/150/200W	160lm/w	Ø300 x 134

**Accessories**

Code	Description
GY830-SEN-PIR	Plug and Play PIR Sensor
GY830-SEN-M	Plug and Play Microwave Sensor
GY830-SEN-BT	Plug and Play Bluetooth Module
GY830-SEN-REM	Remote Control for Gy830



GY830-SEN-REM



GY830-SEN-M



## SHALLOW BOWL INDUCTION HIGH BAY LIGHT

Supply Voltage:  
180-260VAC  
6000K



c/w glass bowl



c/w glass bowl

### Accessories



Code	GDD-N*	GDD-V*	Code	GDD-BGLASS
*Add watts to code	150W, 200W, 250W	150W, 200W, 250W	Description	Spare glass bowl
Luminous Efficiency	80lm/W	80lm/W		
Beam Type	Wide	Narrow		
Reflective Coating	Nano-coating	Vacuum Coating		
<b>Size</b>	<b>Power (W)</b>	<b>Ø (mm)</b>	<b>Code</b>	<b>GDD-BACR</b>
	150	Ø470	Description	Spare Acrylic bowl
	200	Ø506		
	250	Ø556		

## INDUCTION HIGH BAYS

### Reflectors for Induction High Bays

Polycarbonate. Supplied c/w white collar



Complete fitting



Bowl Cover

### Reflectors for Induction High Bays - Aluminium

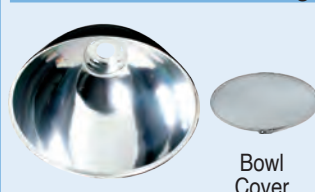

Bowl Cover



c/w glass bowl cover & fixing clips

### Control Gear IP43

Supply Voltage:  
180-260VAC



Size	Lamp Size	Reflector	Bowl Cover	Reflector	Bowl Cover	Reflector	Code	CHG-GB*
410mm	80 - 200W	PCR-410	NBC114-2	-	-	-	*Add power to code	80W, 100W, 120W, 150W, 200W, 250W
485mm	80 - 200W	-	-	ALR-485	RW-AL485	-	Material	Die Cast Aluminium
505mm	80 - 250W	-	-	-	-	ALR-505SH	Description	Gear box with built in ballast for induction lamp
570mm	250W	PCR-570	NBC114-4	ALR-570	RW-AL570	-		

To put together a complete fitting order: 1x Reflector, 1x Control Gear, 1x Lamp

## INDUCTION BALLASTS

### Ballasts for Low Frequency Induction Lamps

PF: 0.99. Operating Temperature: -35°C to 50°C. Frequency: 230kHz ±30

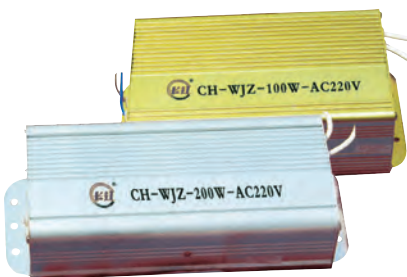

Code	Size L x W x H	Supply Volts
CH-WJZ-80W	191 x 100 x 56mm	180-260VAC
CH-WJZ-100W	191 x 100 x 56mm	180-260VAC
CH-WJZ-120W	191 x 100 x 56mm	180-260VAC
CH-WJZ-150W	191 x 100 x 56mm	180-260VAC
CH-WJZ-200W	206 x 110 x 56mm	180-260VAC
CH-WJZ-250W	206 x 110 x 56mm	180-260VAC
CH-WJZ-300W	206 x 110 x 56mm	180-260VAC

## INDUCTION LAMPS

**Low-Frequency Induction Lamps** - Supply volts 160-260VAC | PF: 0.98 | Quick starting | CRI: 80 | Ballast to be ordered separately

- WW - 2700K
- CW - 4000K
- DL - 6000K



Rectangular



IN-AD



Ring	Code <sup>^</sup>	Lamp Size	Code	Lamp Size	Lamp Power	Lumen	*Add colour to Code
	CH-HX-80W*	225 x 215 x 78mm	CH-JX-80W*	300 x 142 x 78mm	80W	6000-6400lm	WW / CW / DL
	CH-HX-100W*	225 x 215 x 78mm	CH-JX-100W*	300 x 142 x 78mm	100W	7500-8200lm	WW / CW / DL
	CH-HX-120W*	305 x 275 x 78mm	CH-JX-120W*	370 x 142 x 78mm	120W	9225-9840lm	WW / CW / DL
	CH-HX-150W*	340 x 295 x 79mm	CH-JX-150W*	410 x 142 x 78mm	150W	11475-12699lm	WW / CW / DL
	CH-HX-200W*	355 x 315 x 89mm	CH-JX-200W*	500 x 150 x 90mm	200W	15000-17000lm	WW / CW / DL
	CH-HX-250W*	420 x 395 x 90mm	CH-JX-250W*	550 x 155 x 90mm	250W	18750-21250lm	WW / CW / DL
	CH-HX-300W*	430 x 400 x 90mm	CH-JX-300W*	550 x 160 x 90mm	300W	22500-28050lm	WW / CW / DL

<sup>^</sup>Includes IN-AD lampholder adaptor for use in high bay fittings.

2 Year warranty on all LED products, & 1 Year warranty on all products that carry batteries, unless otherwise specified. Warranty void if adequate surge protection is not installed on LED products. See page 149

## HIGH BAY WITH CONTROL GEAR

Reflector to be ordered separately

**High Pressure Sodium**



**Metal Halide**



**Mercury Vapour**



Power	HPS Code	Starting Current	Running Current	MH Code	Starting Current	Running Current	MV Code	Starting Current	Running Current
250W	HBB-250HPS	2.10A	1.42A	HBB-250MH	3.00A	1.35A	HBB-250MV	2.60A	1.35A
400W	HBB-400HPS	3.80A	2.20A	HBB-400MH	3.80A	2.20A	HBB-400MV	4.20A	2.10A

**Polycarbonate Highbays**



Supplied c/w white collar

**Control Boxes for Polycarbonate Highbays**



**Aluminium Highbays**



**Control Boxes for Aluminium Highbays**



Size	Reflector Code	Bowl Cover Code	Code	GB-18	GHK03	GHK05	Size	Reflector Code	Bowl Cover Code	GHK03
410mm	PCR-410	NBC114-2	Size(mm)	240x190x160	260x270x255	225x225x170	410mm	ALR-410	-	260x270x255
485mm	-	-	Material	Sheet Steel	Die-cast Aluminium	Die-cast Aluminium	485mm	ALR-485	RW-AL485	Die-cast Aluminium
570mm	PCR-570	NBC114-4	IP-Rating	IP20	IP43	IP20	570mm	ALR-570	RW-AL570	IP43

## HIGH BAY WITHOUT CONTROL GEAR



Bowl



Code	NB8012	DH-6389	DH-6387
Type	Aluminium	PC	PC
Lampholder	E40	E40	E40
Size	480mm	Ø340 x 330mm	Ø420 x 400mm
Bowl Code	RW-AL480	-	Included
Material of Bowl	Glass	-	-

For lamps see page 25-26.  
For metal halide ballasts see page 159-160.



NB150GB

c/w 1m chain



c/w 1m chain



c/w 1m chain and glass bowl



Code	NB1065-310	NB1065-365	NB1128-310-AL	NB1128-410-AL	NB8016-325	NB8016-430
Type	PC	PC	Aluminium	Aluminium	Aluminium	Aluminium
Lampholder	E27	E27	E27	E27	E27	E40
Size	310Ø x 180mm	365Ø x 240mm	310Ø x 125mm	410Ø x 265mm	325Ø x 375mm	430Ø x 375mm
Code for Bowl	NBC1065	-	NBC1128	NBC1128-410	Included	Included

NEW

## LED T-BAY / HIGHBAY

Input Voltage: 120-277VAC | 120° Viewing Angle | 1-10V Dimming | Colour Temperature 5000K | c/w Mounting Kit | Applications: Industrial



**5 Year Warranty!**

TS-HB-KIT

Code	Wattage	Lumens	Size (mm)
TS-FHB1-110W	110W	14300lm	604 x 244 x 50
TS-FHB2-165W	165W	21450lm	604 x 320 x 50
TS-FHB3-220W	220W	28600lm	604 x 440 x 50
TS-FHB5-165W	165W	21450lm	1168 x 320 x 50
TS-FHB5-220W	220W	28600lm	1168 x 320 x 50
TS-FHB5-300W	300W	39000lm	1168 x 320 x 50

### Additional Accessories

Code	Description
TS-HB-KIT	Chain Mounting Kit (Chain Excluded)

## T-BAY FLUORESCENT FITTINGS

### T5 Louvred High Bay Fittings

- With Electronic Ballast
- Steel Grey Powder Coated
- For food industry applications use in combination with tube sleeves



TB-428

TB-280

Code	Code	Size (mm)	Wattage	Lamp
2 Lamp	4 Lamp	L x W x H	per Lamp	Type G5
TB-235	-	1493 x 291 x 48	35W (5FT)	FLT5-35W
TB-254	-	1193 x 291 x 48	54W (4FT)	FLT5-54W
TB-280	-	1493 x 291 x 48	80W (5FT)	FLT5-80W
-	TB-454	1193 x 518 x 48	54W (4FT)	FLT5-54W
-	TB-480	1493 x 518 x 48	80W (5FT)	FLT5-80W

Lamps excluded. For lamps see page 19

### Accessories

Code	Description
5L2-35E	Electronic Ballast for 2 x 35W
5IC2-54E	Electronic Ballast for 2 x 54W
SI-280	Electronic Ballast for 2 x 80W
TB-1493-RAIL	2 x Diffuser Rail 1493 x 31 x 7mm
TB-1493-DIFF4	Transparent Acrylic Diffuser 1493 x 498 x 3mm



Mounting Bracket Included



### Compact T5 Louvred High Bay Fittings

- With Electronic Ballast
- White Powder Coated
- For food industry applications use in combination with tube sleeves



HB-L628A

HB-L428A

Code	Code	Size (mm)	Wattage	Lamp
4 Lamp	6 Lamp	L x W x H	per Lamp	Type G5
HB-L428A	-	1170 x 332 x 76	28W (4FT)	FLT5-28W
HB-L435A	-	1470 x 332 x 76	35W (5FT)	FLT5-35W
HB-L454A	-	1170 x 332 x 76	54W (4FT)	FLT5-54W
HB-L480A	-	1470 x 332 x 76	80W (5FT)	FLT5-80W
-	HB-L628A	1170 x 502 x 76	28W (4FT)	FLT5-28W
-	HB-L654A	1170 x 502 x 76	54W (4FT)	FLT5-54W
-	HB-L635A	1470 x 502 x 76	35W (5FT)	FLT5-35W
-	HB-L680A	1470 x 502 x 76	80W (5FT)	FLT5-80W

Lamps excluded. For lamps see page 19.

### Accessories

Code	Description
5L2-28E	Electronic Ballast for 2 x 28W
5L2-35E	Electronic Ballast for 2 x 35W
5IC2-54E	Electronic Ballast for 2 x 54W
SI-280	Electronic Ballast for 2 x 80W



**NEW** LED LINEAR HIGHBAYS

5 Year Warranty!

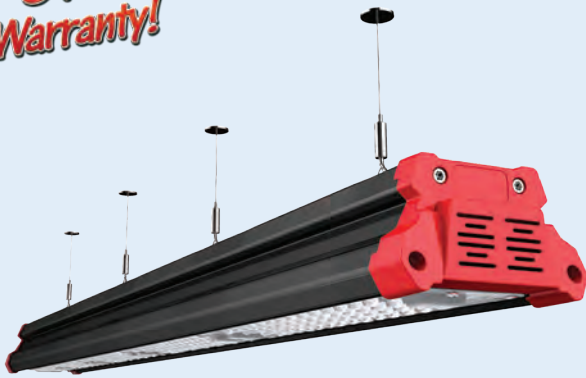

**Industrial Bay - IP65**

Input Voltage: 240VAC | Phillips SMD LEDs | Operating Temperature: -20°~ 50° | Meanwell Driver | Colour Temp: 5500K | 1-10V Dimmable | Supplied with Suspension Kit and Mounting Clips

Code	Wattage	Lumens	Beam Angle	Dimensions
LBL-50W-60X100	50W	5000lm	60° x 100°	341 x 135 x 84
LBL-100W-60X100	100W	10000lm	60° x 100°	631 x 135 x 84
LBL-150W-30X70	150W	19500lm	30° x 70°	718 x 137 x 102
LBL-200W-30X70	200W	18000lm	30° x 70°	1217 x 135 x 84



BR-HBL-BRKT

BR-HBL-SEN

**Additional Accessories**

Code	Description
BR-HBL-SEN	Radar Occupancy Sensor 360°, 15m Max Height
BR-HBL-BRKT	Mounting Bracket for wall or ceiling mounting

5 Year Warranty!



140lm/W

**Linear Highbay - IP66**

Input Voltage 85-265VAC | 140lm/W | 5500K | 1-10V Dimmable | 240° Beam Angle | Frosted Diffuser | Applications: Airport, Parking Garages, Industrial Warehouses, Gymnasiums

Code	Wattage	Lumens	Size (mm)
IK-LHB-80W	80W	11200lm	600 x 154 x 70
IK-LHB-150W	150W	21000lm	1200 x 154 x 70
IK-LHB-200W	200W	28000lm	1500 x 154 x 70
IK-LHB-240W	240W	33600lm	1500 x 154 x 70

INDUSTRIAL

5 Year Warranty!

PURE LIGHT LED PRODUCTS  
MADE IN SOUTH AFRICA

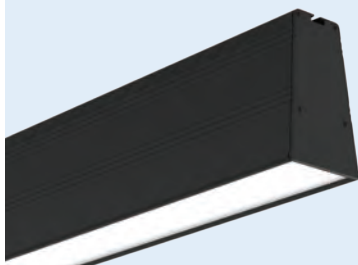

MASTER-SLH

MASTER-H

MASTER-SM

**Warehouse Master Highbay - IP20**

Operating Voltage: 170-264VAC | Over Voltage Protection: 320VAC, 48h | Burst Surge Protection: 2kV - 4kV | Power Factor > 0.97 | CRI: +70 | Colour Temperature: 4000K

Code	Wattage	Lumens	Size (mm)
WH-MASTER2-*	64W	8250lm	65 x 110 x 470
WH-MASTER3-*	100W	12600lm	65 x 110 x 720
WH-MASTER4-*	134W	16900lm	65 x 110 x 970
WH-MASTER5-*	170W	21200lm	65 x 110 x 1220

\* Add beam Angle to Code: **M**(13°), **W**(24°), **WW**(52°), **O**(23+104°)

**Additional Accessories**

Code	Description
MASTER-SLH	Slide In Hanger Bracket
MASTER-SM	Side Mount Hanger Bracket
MASTER-H	Hanging Bracket

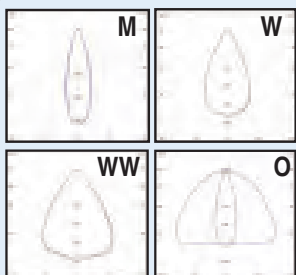

LIGHTING

NEW

## LED LINEAR LOWBAY IP20

5 Year  
Warranty!

PURE LIGHT LED PRODUCTS  
MADE IN SOUTH AFRICA

### Single Linear Bay

Operating Voltage: 198-264VAC | Over Voltage Protection: 320VAC, 48h | Burst Surge Protection up to 2kV | Power Factor > 0.97 | CRI +70 | Colour Temp: 5000K | High Transmission Diffuser Matt 76% | Beam Angle 90°

Code	Wattage	Lumens	Size (mm)
BASE-LED-20	19W	2350	600 x 44 x 41
BASE-LED-25	25W	3550	600 x 44 x 41
BASE-LED-35	38W	4700	1160 x 44 x 41
BASE-LED-50	50W	7150	1160 x 44 x 41

\* Add -S to code for sensor

### Accessories

Linear Bay Lights can be combined in clusters with 2, 3 and 4 luminaires in a set. Adjustable 15°, 30° and 45°

Code	Description	Size (mm)
BASE-C2	2 Cluster Bracket	150
BASE-C3	3 Cluster Bracket	256
BASE-C4	4 Cluster Bracket	362

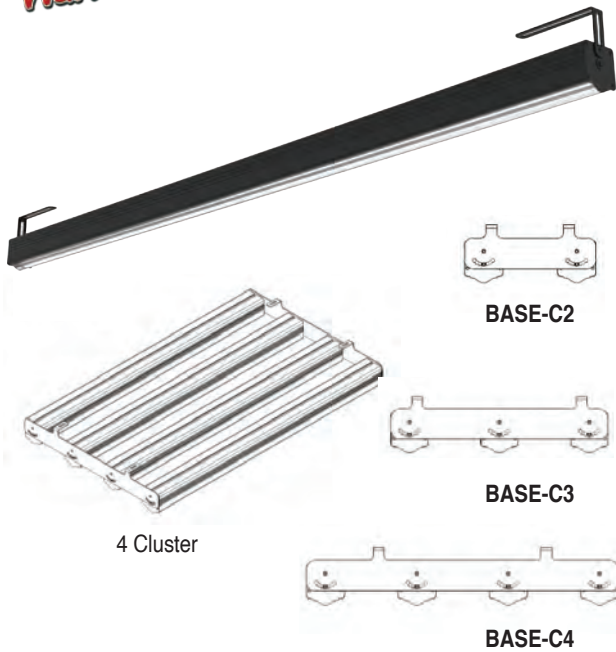

## LED HIGHBAY/LOWBAY IP65

Supply Voltage:  
90-246VAC  
• Meanwell Drivers  
• Bridge Lux LEDs



Code	LGCD60WD-*	LGCD90WD-CW	LGCD120WD-*	HLB00202-*
Power	60 x 1W (70W)	90 x 1W (90W)	120 x 1W (135W)	58 x 1.73W (100W)
Luminous Flux	7200lm	10800lm	14400lm	2622lm
Equivalent Brightness	150W	250W	400W	600W
Size (mm)	346 x 320 x 174	476 x 320 x 174	606 x 320 x 174	298D x Ø378

\*Add colour to code: ○ CW (Cool White 5000k-5500k), ○ WW (Warm White 2700-3000k)



Code	LGCD150WE-*	LGCD180WE-*	LGCD210WE-WW
Power	150W	180W	210W
Luminous Flux	16500lm	19800lm	23100lm
Equivalent Brightness	500W	600W	700W
Size (mm)	590 x 395 x 190	615 x 395 x 190	700 x 395 x 190

\*Add colour to code: ○ CW (Cool White 5000k-5500k), ○ WW (Warm White 2700-3000k)

2 Year warranty on all LED products, & 1 Year warranty on all products that carry batteries, unless otherwise specified. Warranty void if adequate surge protection is not installed on LED products. See page 149

## LED GAS STATION CANOPY LIGHT IP65

**5 Year Warranty!**

Colour Temperature: 6000K



**CYZ-100- R** - Recessed  
Material: Aluminium Alloy

**NEW**

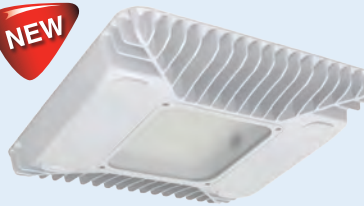

**CYZ-ECO-100- S** - Surface  
Material: Aluminium Alloy

**NEW**



**TS-GCP**  
Material: Die-cast Aluminium / PC

Code	Supply Voltage	Watts	Lumens	Size (mm)	Cut-out Size (mm)
CYZ-100-R	100-277VAC	100W	11000lm	420 x 420 x 160	360 x 360
CYZ-100-S	100-277VAC	100W	11000lm	420 x 420 x 160	-
CYZ-ECO-100-R	100-277VAC	100W	11000lm	350 x 248 x 115	316 x 200
CYZ-ECO-100-S	100-277VAC	100W	11000lm	380 x 380 x 70	-
TS-GCP0840	120-177VAC	40W	4800lm	255 x 255 x 86	-
TS-GCP1070	120-177VAC	70W	8400lm	255 x 255 x 86	-

## LED PARKING BAY LIGHT IP65

Input Voltage: 230VAC | 160° Beam Angle | Colour Temperature: 5000K | CRI > 80 | Operating Temp -40°C to +40°C | 1-10V Dimmable

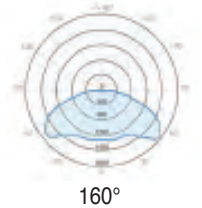

Surface Mount



Pole-Mount



Surface mount with side wiring

Standard

Code	Wattage	Lumens	Size (mm)
BT-ST-60W	60W	8100lm	Ø290 x 114

**With Built-In Sensor** - Dimmable | Detection Area Ø12m @ 6m max | Daylight sensing 5lux-150lux | Detection Angle: 150° Wall Mount, 360° Ceiling Mount

Code	Wattage	Lumens	Size (mm)
BT-VT-60W	60W	8100lm	Ø290 x 114

**Accessories** - Remote Control to configure **BT-VT-60W**

Code	Description
MC612V-IR	Remote Control



MC612V-IR

## LOW BAY FITTING E40 BASE

Input Voltage: 230VAC | Fitting size: 715 x 320 x 210mm | Lamp not included

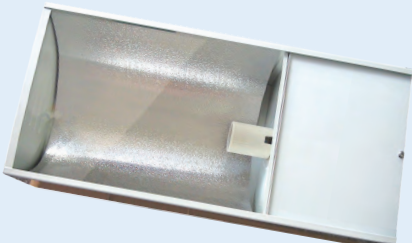

Code	Wattage	Lamp Code	Gear
LB-250MH	250W	MT-250-E40	Metal Halide low bay
LB-400MH	400W	MT-400-E40	Metal Halide low bay
LB-1001	-	-	Empty (no control gear)

LIT

2 Year warranty on all LED products, & 1 Year warranty on all products that carry batteries, unless otherwise specified. Warranty void if adequate surge protection is not installed on LED products. See page 149



## LED STREET LAMP - RETRO FIT

- WW - 2700K
- CW - 4200K
- DL - 6000K



Input Voltage: 230V | Ideal for Retrofit Installations



Code	Wattage	Lumens	Base	Size (mm)	*Colour Temp
SP90-*	28W	2100lm	E40	Ø90 x 275L	WW / DL
TK-VCL-36-*	36W	4680lm	E27	Ø98 x 245	CW / DL
TK-VCL-54-*	54W	7020lm	E40	Ø98 x 245	CW / DL

## LED STREET LIGHTS

- DL - 6000K

**3 Year  
Warranty!**

**Eco 2 LED Street Light IP66** - Input Voltage: 100-300VAC | Beam Angle: 120° | CRI > 80

Die-Cast Aluminum + Tempered Glass



Code	Wattage	Lumens	Size (mm)	Colour Temp
SL-016-20W-DL	20W	22000lm	300 x 110 x 63	DL
SL-016-30W-DL	30W	3300lm	300 x 110 x 63	DL
SL-016-50W-DL	50W	5500lm	400 x 150 x 78	DL
SL-016-100W-DL	100W	11000lm	500 x 180 x 78	DL
SL-016-150W-DL	150W	16500lm	500 x 180 x 78	DL
SL-016-200W-DL	200W	22000lm	500 x 180 x 78	DL

- CW - 4200K

**3 Year  
Warranty!**



**Slim - Eco LED Street Light IP65** - Input Voltage: 85 - 265VAC | 110lm/W

Code	Wattage	Lumens	Size (mm)	Colour Temp
LL-SL-60	60W	6600lm	475 x 215 x 145	CW
LL-SL-120	120W	13200lm	685 x 270 x 145	CW

- DL - 6000K

**3 Year  
Warranty!**



**Cobra LED Street Light IP65** - Input Voltage: 90-305VAC | High Power Single LED Chip |

Die-Cast Aluminium Body

Code	Wattage	Lumens	Size (mm)	Colour Temp
LU793-60	60W	5700lm	640 x 250 x 80	DL
LU793-100	100W	9500lm	720 x 280 x 95	DL
LU793-120	120W	11400lm	850 x 315 x 95	DL
LU793-150	150W	14200lm	850 x 315 x 95	DL
LU793-200	200W	19000lm	850 x 315 x 95	DL

**NEW**

## LED STREET LIGHTS IP65

○ DL - 6000K

**5 Year Warranty!**
**Module LED Street Light** - Input Voltage: 230VAC | Type III Beam Angle (85 x 135°)

Code	Wattage	Lumens	Size (mm)	Colour Temp
YR-ST-50W	50W	6000lm	373 x 300 x 90	DL
YR-ST-100W	100W	12000lm	473 x 347 x 147	DL
YR-ST-150W	150W	18000lm	529 x 600 x 90	DL
YR-ST-200W	200W	24000lm	607 x 300 x 90	DL
YR-ST-240W	240W	28800lm	685 x 300 x 90	DL
YR-ST-300W	300W	36000lm	763 x 300 x 90	DL

**NEW**

## LED PARKING LOT LIGHT IP65

**5 Year Warranty!**

Input Voltage: 100-277VAC | 120lm/W | Colour Temperature: 5700K | Light Distribution "Type IV" | Supplied with Type A Slip Fitter | Suitable for Parking Lots, Residential areas, Landscapes, Roads and Architecture



Code	Wattage	Lumens	Size (mm)
YR-PL345-100	100W	12000lm	367 x 348 x 68
YR-PL345-150	150W	18000lm	367 x 348 x 68
YR-PL670-200	200W	24000lm	434 x 353 x 75
YR-PL670-300	300W	36000lm	555 x 348 x 78

### Mounting Brackets

Code	Description
YR-PL-1	Type A (Slip Fitter)
YR-PL-2	Type B (Square/Round Pole Mount with Slip-Fitter Function)
YR-PL-3	Type C (Square/Round Pole Mount)
YR-PL-4	Type D (Trunnion)

**NEW**

## LED STREET LIGHTS IP65

**5 Year Warranty!**

○ DL - 6000K

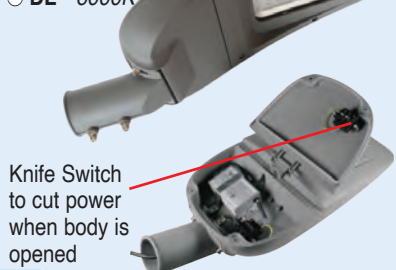
**Elegant LED Street Light** - Input Voltage: 100-265VAC | High Lumen Output > 120lm/W | Installed with Knife Switch to cut power when body is opened | Adjustable Spigot with bottom & side entry adaptor | Die-Cast Aluminium Body

Knife Switch to cut power when body is opened

Code	Wattage	Lumens	Size (mm)	Colour Temp
LEDL19-60W	60W	7200lm	640 x 265 x 110	DL
LEDL19-80W	80W	9600lm	640 x 265 x 110	DL
LEDL19-100W	100W	12000lm	700 x 305 x 120	DL
LEDL19-120W	120W	14400lm	700 x 305 x 120	DL

NEW

5 Year  
Warranty!

○ DL - 6000K



## LED STREET LIGHTS IP65

**Elegant with 7 Pin Nema Socket LED Street Light** - Input Voltage: 100-265VAC | High Lumen Output > 120lm/W | Inventronics 0-10V Dimmable Driver | 7 Pin Nema Socket | Die Cast Aluminium | Installed with Knife Switch to cut power when body is opened | Adjustable Spigot with bottom & side entry adaptor.

Code	Wattage	Lumens	Size (mm)	Colour Temp
LED-N19-60	60W	6000lm	616 x 259 x 186	DL
LED-N19-80	80W	8000lm	616 x 259 x 186	DL
LED-N19-100	100W	10000lm	676 x 303 x 186	DL
LED-N19-120	120W	12000lm	676 x 303 x 186	DL



### Photo Controller:

Rated Voltage: 110-277VAC | Typical on/off delay: 50lux | Typical Time delay: 10sec | Ambient Temp: 40 ~ 170°C | Size: Ø84 x 86mm | IP65

Code	JL-241C	JL-242C	JL-243C
Constant on/off Dimming	•	•	•
Midnight Dimming	X	•	•
LED Decay Compensation	X	X	•

**Constant On/Off Dimming:** Constant lighting level, in accordance with the natural sunlight level detected. When the natural lighting is higher than 110% of the rated level, power will be disconnected to increase power saving.

**Midnight Dimming:** Output lowered to a customized percentage to save power after midnight until dawn, as well as reduce light pollution to environment.

**LED Decay Compensation:** Output partially reserved for compensating decay. It will extend the work life of a LED fixture significantly.

Knife Switch to cut power when body is opened

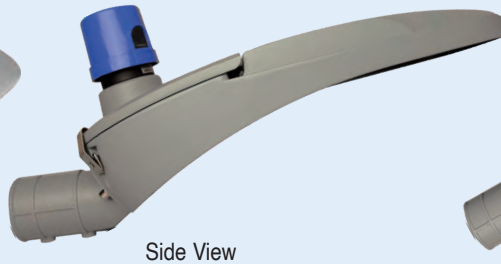
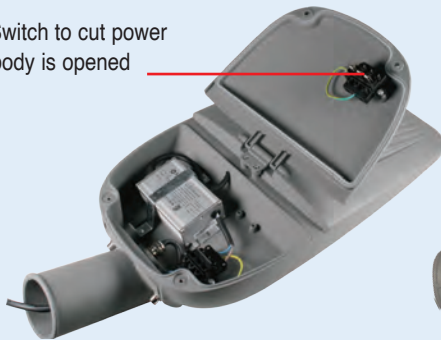

Side View

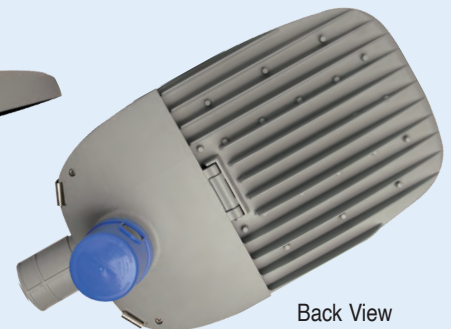

Back View

CREE

○ DL - 6000K

3 Year  
Warranty!

40W & 60W

**Flux LED Street Light** - Input Voltage: 220-240VAC | Die-Cast Aluminium Body

Code	Wattage	Lumens	Size (mm)	Colour Temp
ZY-6009-LED-40	40W	4000lm	565 x 270 x 145	DL
ZY-6009-LED-60	60W	6000lm	640 x 270 x 160	DL
ZY-6009-LED-80	80W	8000lm	755 x 300 x 215	DL
ZY-6009-LED-120	120W	12000lm	862 x 360 x 231	DL



80W & 120W

## HID STREET LIGHTING IP65

**Flux HID Street Light** Input Voltage: 220-240VAC | Die-Cast Aluminium Body | Tempered Glass Diffuser | Lamps Excluded - For Lamps see page 25-26

Code	Wattage	Lamp Holder	Pole Entry	Size (mm)
ZY-6009-70-*	70W	E27	Side & Bottom	565 x 220 x 145
ZY-6009-150-*	150W	E27	Side & Bottom	640 x 270 x 160
ZY-6009-250-*	250W	E40	Side & Bottom	755 x 300 x 215
ZY-6009-400-*	400W	E40	Side & Bottom	862 x 358 x 215



70W, 150W, 250W



400W

\*Add type of Control Gear required to code: **MH** (Metal Halide), **HPS** (High Pressure Sodium), **EMPTY** (No Control Gear)

## HID STREET LIGHTING



Lamp Excluded-  
For Lamps see Page 25-26

**Path Finder HID** - Input Voltage: 230VAC | SANS 475, SANS 60598-2-3 | UV stabilised polymer body, grey in colour | High impact UV stabilised clear acrylic lens | **IP54** Gear compartment, **IP65** Lamp compartment | Side Entry

Code	Wattage	Lamp Type	Ignitor	Lamp Holder	Size (mm)
PATH-70-MH	70W	MH & HPS	Yes	E27	591 x 238 x 196
PATH-70-HPS	70W	HPS with Internal Ignitor	No	E27	591 x 238 x 196
PATH-100-MH	100W	MH & HPS	Yes	E27	591 x 238 x 196
PATH-100-HPS	100W	MH & HPS	Yes	E40	591 x 238 x 196
PATH-150-MH	150W	MH & HPS	Yes	E27	591 x 238 x 196
PATH-150-HPS	150W	HPS	Yes	E27	591 x 238 x 196
PATH-EMPTY	EMPTY	-	No	E27	591 x 238 x 196

\*Add type of Control Gear required to code: **MH** (Metal Halide), **HPS** (High Pressure Sodium), **EMPTY** (No Control Gear)



**Optic HID** - Input Voltage: 220-240VAC | Die-Cast Aluminium Body | Glass Diffuser | Lamps Excluded | **IP65**

Code	Wattage	Lamp Holder	Pole Entry	Size (mm)
STN007	250W	E40	Side	587L x 288W x 204H
ST9012-*	250W	E40	Side	660L x 300W x 190H

**STN007** For use with LED Lamp. \*Add type of Control Gear required to code: **MH** (Metal Halide), **HPS** (High Pressure Sodium)

## PL STREET LIGHT



Lamp Excluded-  
For Lamps see Page 18-19

**Path Finder PL** - Input Voltage: 230VAC | SANS 475, SANS 60598-2-3 | UV stabilised polymer body, grey in colour | High impact UV stabilised clear acrylic lens | **IP54** Gear compartment, **IP65** Lamp compartment

Code	Wattage	Lamp Holder	Pole Entry	Size (mm)
PATH-218	2 x 18W	PLCE	Side	591.5 x 238.8 x 196
PATH-226	2 x 26W	PLCE	Side	591.5 x 238.8 x 196

## EMPTY STREET LIGHT FITTING **IP65**



Input Voltage: 220-240VAC | Complete with 15° Mounting Bracket | E27 Lamp Holder | Polycarb Body | Polycarb Diffuser | Lamps Excluded

Code	Wattage	Pole Entry	Size (mm)
<b>Standard</b>			
SFL-1001	1 x 45W Max	Side	590L x 170W x 150H
SFL-1002	2 x 45W Max	Side	590L x 250W x 170H
<b>Complete with Photocell</b>			
SFL-1001-P	1 x 45W Max	Side	590L x 170W x 150H
SFL-1002-P	2 x 45W Max	Side	590L x 250W x 170H



Input Voltage: 230VAC | Complete with Mounting Arm and Day/Light Switch | E27 Lamp Holder | Die-Cast Aluminium Body | PS Diffuser | Lamps Excluded

Code	Wattage	Pole Entry	Size (mm)
SFL-3001	60W Max	Side	Ø300 x 470H

## INDUCTION STREET LIGHTS **IP65**



Input Voltage: 230VAC | Colour Temperature: 5000K | Lamp Excluded - For Lamps see Page 39

Code	*Add Wattage to Code	Lumen / Wattage	Size (mm)
CHL-005-*	80W, 100W, 120W	80lm	1000 x 405 x 210
JRD-DP-LD2001-*	80W, 100W, 120W	80lm	810 x 340 x 250
JRD-DP-LD2002-*	80W, 100W, 120W	80lm	960 x 410 x 200

## LED INDUSTRIAL BULKHEAD IP65

Die-Cast Aluminium Base | Glass Diffuser with Stainless Steel Clips | Colour Temperature: 6000K | Size: 418 x 314 x 203 | DOB (Driver on Board) external driver available

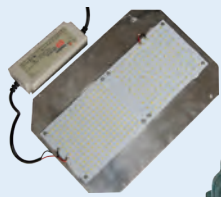

Retrofit Kit



Complete Fitting

External Driver		Wattage	Lumens	NEW DOB Driver on Board	
Complete Fitting Code 85-265VAC*	Retrofit Kit with external driver 85-265VAC*			Complete Fitting DOB Code 220-240VAC*	Retrofit Kit with driver on board 220-240VAC*
IBG-LED-30W	IBG-LEDRRK-30W	30W	3000lm	IBG-LED-30W-DOB	IBG-LEDRRK-30W-DOB
IBG-LED-60W	IBG-LEDRRK-60W	60W	6000lm	IBG-LED-60W-DOB	IBG-LEDRRK-60W-DOB
IBG-LED-100W	IBG-LEDRRK-100W	100W	9000lm	IBG-LED-100W-DOB	IBG-LEDRRK-100W-DOB
* 5 Year Warranty				* 2 Year Warranty	

Emergency inverter available for IBG-LED-30W, 60W, 100W. See page 161 (ECLAT-39410 / ECLAT-39482)

## LASCON B40 LED RETROFIT KIT



B40-LEDRRK



LASCON B40 Bulkhead

B40 Retrofit LED - Designed to be used in existing LASCON B40 Luminaires | CRI>80 | 6000K | Driver on board

Code	Wattage	Lumens
B40-LEDRRK-60W-DOB	60W	6000lm
B40-LEDRRK-100W-DOB	100W	10000lm

## LED WALL PACK IP65

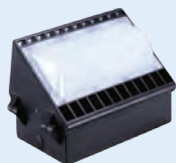

LS-WP

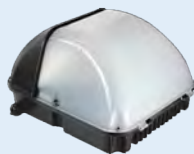

RWSP-\*-B



RWSP-\*-C

- Supply Voltage: 90-240V
- Die-Cast Aluminium
- Colour Temp: 6000K

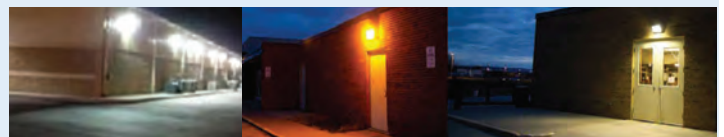

Code	Wattage	Lumens	Size (mm)
LS-WP30W	30W	2100lm	366 x 185 x 233H
LS-WP60W	60W	4200lm	366 x 185 x 233H
RSWP-30W-B	30W	2100lm	287 x 272 x 188
RSWP-60W-B	60W	4200lm	287 x 272 x 188
RSWP-30W-C	30W	2100lm	264 x 308 x 182
RSWP-60W-C	60W	4200lm	264 x 308 x 182

## INDUSTRIAL BULKHEADS - INDUCTION



JRD-BG9012-40W



JRD-BG9013-40W



EAL-BM

Industrial Bulkhead - Input Voltage: 230VAC

Code	Wattage	Lumens	Size (mm)
<b>Induction - IP65</b>			
JRD-BG9012-40W	40W	3200lm	275 x 270 x 190
JRD-BG9013-40W	40W	3200lm	288 x 308 x 180

Induction - IP66 - Glass fill Nylon Base | Polycarbonate Diffuser

EAL-BM-80W	80W	6400lm	320 x 420 x 180
EAL-BM-100W	100W	8000lm	320 x 420 x 180

## INDUSTRIAL BULKHEADS - ENERGY SAVING



BK6009

Industrial Bulkheads - IP55 - Input Voltage: 230VAC | Electronic Ballast | Lamps Included | Die-Cast Aluminium body

Code	Spare Lamp	Wattage / Lamp	Lumens	Size (mm)
BK6009-26	PLC-26-CW	2 x 26W	3400lm	260 x 300 x 180
BK6009-42	PLCE-42-CW	2 x 42W	3500lm	260 x 300 x 180

## INDUSTRIAL BULKHEADS - HID

Lamp to be ordered separately.

**Industrial Bulkheads IP44** - 230VAC, Size: 310 x 258 x 225(D)mm, Polycarbonate Diffuser



**IBPC**

H.P.S. (High Pressure Sodium)  
M.H. (Metal Halide)  
M.V. (Mercury Vapour)

Watts	Code						Lamp Holder
	H.P.S.	Lamp	M.H.	Lamp	M.V.	Lamp	
70W	IBPC-70IHPS	SD-70I	IBPC-70MH	MTE-70	-	-	E27
125W	-	-	-	-	IBPC-125MV	QE-125	E27
150W	IBPC-150HPS/MH	SD-150-E27	IBPC-150HPS/MH	MTE-150	-	-	E27
<b>Energy Saving Fittings</b> - Excluding Lamps. Fitted Polycarbon diffuser and die-cast.							
2 x 18W	IBPC-218	PLC-18					BCF-G24d2
2 x 26W	IBPC-226	PLC-26					BCF-G24d3
2 x 42	IBPC-242	PLCE-42					BCF-G24q4
	NB1269	-	Empty Body c/w Lampholder				E27

Lamp to be ordered separately.

**Industrial Bulkheads IP65** - 230VAC, Size: 418 x 314 x 203(D)mm Glass Diffuser with stainless steel clips.

Die-cast aluminium base.



**IBG**

H.P.S. (High Pressure Sodium)  
M.H. (Metal Halide)  
M.V. (Mercury Vapour)

Watts	Code						Lamp Holder
	H.P.S.	Lamp	M.H.	Lamp	M.V.	Lamp	
70W	IBG-70IHPS	SD-70I	-	-	-	-	E27
150W	IBG-150HPS/MH	SD-150	IBG-150HPS/MH	MTE-150	-	-	E27

## INDUSTRIAL BULKHEADS - EMPTY



**BK6009**



**NB1269**



**EL-616**

**Industrial Bulkheads** - Input Voltage: 230VAC | E27 Lamp Holder | Lamps Excluded

Code	IP Rating	Size (mm)
<b>BK6009</b>	<b>IP65</b>	260 x 300 x 180
<b>NB1269</b>	<b>IP44</b>	310 x 258 x 255
<b>EL-616</b>	<b>IP65</b>	418 x 314 x 203



**BK6003**



**FL1057**

**Rectangular Bulkheads** - Input Voltage: 230VAC | E27 Lamp Holder | Lamps Excluded | Aluminium Body | Glass Cover

Code	IP Rating	Size (mm)
<b>BK6003</b>	<b>IP54</b>	280 x 175 x 133
<b>FL1057</b>	<b>IP65</b>	330 x 230 x 190

**NEW**

## LED INDUSTRIAL VANDAL PROOF

**5 Year Warranty!**



**V004579**



**V004586**

**LED Industrial Round Vandal Proof - IP54** Input Voltage: 220-240VAC | Colour Temp: 4000K | L70B10 ta30 - 100 000h | White painted metal frame RAL9003 with PC Cover | Direct fastening on ceiling or wall light | Applications : Areas with high risk i.e. Prison Cells, Psychiatric Hospitals, Gymaniums and Pedestrian Subways.

Code	Power	Lumens	Size (mm)
<b>CLUMBER3-LED-1500-4K</b>	8W	1047lm	Ø208 x 63
<b>CLUMBER2-LED-2650-4K</b>	19W	1819lm	Ø370 x 63
<b>CLUMBER1-LED-6200-4K</b>	44W	4690lm	Ø505 x 63

**Accessories**

Code	Description
<b>V004579</b>	TORX Security Screw M5 x 12
<b>V004586</b>	BIT25 tool for Screw M5 x 12

**5 Year Warranty!**



**V004579**



**V004586**

**LED Industrial Box Vandal Proof - IP64** Input Voltage: 220-240VAC | Colour Temp: 4000K | L70B10 ta30 - 100 000h | White painted metal frame RAL9003 with PC Cover | Direct fastening on ceiling or wall light | Applications : Areas with high risk i.e. Prison Cells, Psychiatric Hospitals, Gymaniums and Pedestrian Subways.

Code	Power	Lumens	Size (mm)
<b>BOXER-LED-3300-4K</b>	25W	2584lm	700 x 184 x 56
<b>BOXER-LED-6600-4K</b>	53W	5168lm	1257 x 184 x 56
<b>BOXER-LED-8200-4K</b>	66W	6421lm	1537 x 184 x 56

**Accessories**

Code	Description
<b>V004579</b>	TORX Security Screw M5 x 12
<b>V004586</b>	BIT25 tool for Screw M5 x 12

## T8 LED WEATHERPROOF LINEAR LIGHTS IP65

**LED Standard Weatherproof Linear Light IP65** c/w Fuse Links | Easy Replacement | Wired for L+N one end, Link Opposite end. **LED Tubes Excluded**

Fitting Wired for LED Single	LED Tube Code	Lamp Power	Lumen	Size (mm)
LED-YZ-T8-8W-NT	LEDT8-A2FR-CW or DL	1x 8W (2FT)	800lm	675 x 85 x 90
LED-YZ-T8-18W-NT	LEDT8-A4FR-CW or DL	1x 18W (4FT)	1700lm	1278 x 85 x 90
LED-YZ-T8-22W-NT	LEDT8-A5FR-CW or DL	1x 22W (5FT)	1900lm	1578 x 85 x 90

Eg. LED YZ-T8-18W-NT (Fitting) + EMG-LEDT8-A4FR-\* (Tube)

Fitting Wired for LED Double	LED Tube Code	Lamp Power	Lumen	Size (mm)
LED-YZ-T8-2X8W-NT	2x LEDT8-A2FR-CW or DL	2x 8W (2FT)	2x 800lm	675 x 129 x 90
LED-YZ-T8-2X18W-NT	2x LEDT8-A4FR-CW or DL	2x 18W (4FT)	2x 1700lm	1278 x 129 x 90
LED-YZ-T8-2X22W-NT	2x LEDT8-A5FR-CW or DL	2x 22W (5FT)	2x 1900lm	1578 x 129 x 90

Eg. LED YZ-T8-18W-NT (Fitting) + EMG-LEDT8-A4FR-\* (Tube)

For LED tubes see page 1-3 | For Emergency Add Emergency Tube Code on page 3

### Accessories

Code	Wattage
LED-YZ-CLIP/S	Stainless Steel holding clips for YZ Diffuser

**LED Economy Weatherproof Linear Light IP65** Material: ABS & Polycarbonate Diffuser | Supplied without LED Tube

Code	Power	Dimensions
LEDWPT8-109	1 x 9W	650 x 74 x 61mm
LEDWPT8-209	2 x 9W	650 x 110 x 61mm
LEDWPT8-118	1 x 18W	1250 x 74 x 61mm
LEDWPT8-218	2 x 18W	1250 x 110 x 61mm
LEDWPT8-122	1 x 22W	1550 x 74 x 61mm
LEDWPT8-222	2 x 22W	1550 x 110 x 61mm

For LED tubes see page 1-3 | For Emergency Add Emergency Tube Code on page 3

**LED Integrated Weatherproof Linear Light IP65** - Supply Voltage 230VAC | Colour temp 6500K (Daylight) | Snap on lens cover (no clips/screws) | Easy connection (no need to open fitting) | PC Base and Lens / Aluminium heat sink

Code 2 Year	Wattage	Lumen	Max Series Connection	Size (mm)
BW-ECO-18	18W	1500lm	20	590 x 86 x 66
BW-ECO-36	36W	3000lm	10	1180 x 86 x 66
BW-ECO-48	48W	4000lm	8	1480 x 86 x 66

**LED Weatherproof Linear Light with Motion Sensor IP65** - Input Voltage: 230VAC | ABS + PC | Colour Temperature 6000K | Integrated Microwave Sensor | Time Setting: 10sec to 30min | Light Control: 10-2000 lux | Detection Range: 1-8m (Radius) (Adjustable) | Ideal for parking lots

Code	Wattage	Lumen	Size (mm)
BW-ECO2-18	18W	1500lm	568 x 70 x 55
BW-ECO2-36	36W	3000lm	1168 x 70 x 55
BW-ECO2-48	48W	4000lm	1480 x 70 x 55

**LED Mining Weatherproof Linear Light IP65** Input Voltage: 85 - 265VAC | c/w LED Tubes 6000K (Daylight) | c/w 2 x Stainless Steel Clips & 2 x Hooks

Codes c/w LED Tube	Wattage	Supplied with	Size (mm)
MYZ-2X22W	2 x 22W	1.5m Cable & 2P + E 16A Industrial Plug 2 x Daylight LED Tubes	1578 x 129 x 90
MYZ-2X18W-E27	2 x 18W	1.5m Cable & E27 Lamp Holder	1278 x 129 x 90
MYZ-2X22W-E27	2 x 22W	1.5m Cable & E27 Lamp Holder	1578 x 129 x 90

• For LED tubes see page 1-3

• For Emergency Add Emergency Tube Code on page 3



LED Tubes to be ordered separately see page 1-3

Wiring Diagram

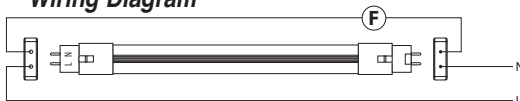

LED-YZ-CLIP/S



LED Tubes to be ordered separately see page 1-3

Accessories Supplied

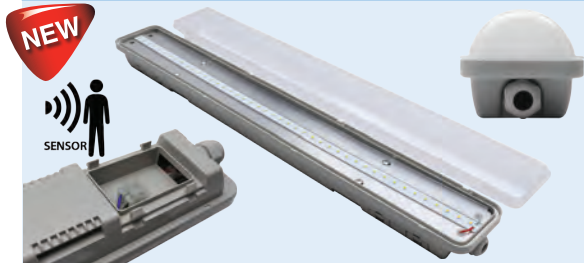

# T8 FLUORESCENT WEATHERPROOF LIGHT FITTINGS IP65



**YZ & F7 Range** - Material: ABS Base & Clip, Clear Poly-Carbonate diffuser | Working Temp: 85°C max | PF >0.97

Lamp Power	Size (mm) L x B x H	Codes			
		Iron Ballast	Electronic Ballast (240V)	Electronic Ballast (110V)	*c/w Emergency Kit
1 x 18W (2FT)	675 x 85 x 90	YZ-8118A	YZ-8118-ELC 240V	YZ-8118-ELC 110V	-
1 x 36W (4FT)	1278 x 85 x 90	YZ-8136A	YZ-8136-ELC 240V	YZ-8136-ELC 110V	YZ-8136-EMG
1 x 58W (5FT)	1578 x 85 x 90	YZ-8158A	YZ-8158-ELC 240V	YZ-8158-ELC 110V	YZ-8158-EMG
2 x 18W (2FT)	675 x 129 x 90	YZ-8218A	YZ-8218-ELC 240V	YZ-8218-ELC 110V	YZ-8218-EMG
2 x 36W (4FT)	1278 x 129 x 90	YZ-8236A	YZ-8236-ELC 240V	YZ-8236-ELC 110V	YZ-8236-EMG
2 x 58W (5FT)	1578 x 129 x 90	-	YZ-8258-ELC 240V	YZ-8258-ELC 110V	YZ-8258-EMG
3 x 18W (2FT)	675 x 220 x 110	F7318	F7318-ELC 240V	-	F7318-EMG
3 x 36W (4FT)	1278 x 220 x 110	F7336	F7336-ELC 240V	-	F7336-EMG

\*1 Lamp fitted with emergency kit @ 11% of full power for 1 hour



**YZ Range - Empty** - Material: ABS Base & Clip, Poly-Carbonate diffuser | Working Temp: 85°C max | Supplied without gear

Lamp Power	Size (mm) L x B x H	Codes			
		Body with Clear Diffuser	Spare Clear Diffuser	Body with Opal Diffuser	Spare Opal Diffuser
1 x 18W (2FT)	675 x 85 x 90	YZ-8118-EMPTY	YZ-8118-DIF	-	-
1 x 36W (4FT)	1278 x 85 x 90	YZ-8136-EMPTY	YZ-8136-DIF	-	-
1 x 58W (5FT)	1578 x 85 x 90	YZ-8158-EMPTY	YZ-8158-DIF	-	-
2 x 18W (2FT)	675 x 129 x 90	YZ-8218-EMPTY	YZ-8218-DIF	-	-
2 x 36W (4FT)	1278 x 129 x 90	YZ-8236-EMPTY	YZ-8236-DIF	YZ-8236-OP-EMPTY	YZ-8236-OP-DIF
2 x 58W (5FT)	1578 x 129 x 90	YZ-8258-EMPTY	YZ-8258-DIF	YZ-8258-OP-EMPTY	YZ-8258-OP-DIF
3 x 18W (2FT)	675 x 220 x 110	-	F7318-DIF	-	-
3 x 36W (4FT)	1278 x 220 x 110	-	F7336-DIF	-	-



**F7D Range - High Temp Rating** - Material: Poly-Carbonate Base & Clear Poly-Carbonate diffuser | Working Temp: 120°C max | PF >0.97 | Cover & internal plate can be hinged

Lamp Power	Size (mm) L x B x H	Codes			
		Iron Ballast	Electronic Ballast (240V)	*c/w Emergency Kit	Spare Clear Diffuser
2 x 36W (4FT)	1268 x 158 x 101	F-7236D	F-7236D-ELC 240V	F-7236D-ELC 110V	F-7236D-DIF
2 x 58W (5FT)	1568 x 158 x 101	-	F-7258D-ELC 240V	F-7258D-ELC 110V	F-7258D-DIF



Accessories - For YZ Range		Accessories - For F7 & F7-D Range	
Code	Description	Code	Description
YZ-CLIP/P	Plastic holding clips for YZ Diffuser	F7-CLIP/P	Plastic holding clips for F7 Diffuser
YZ-CLIP/S	S/Steel holding clips for YZ Diffuser	F7-CLIP/S	S/Steel holding clips for F7 Diffuser
YZ-CLIP/M	S/Steel surface mount clips	F7D-CLIP/P	Plastic holding clips for F7-D Diffuser
YZ-CLIP/C	Chassis assembly clips	F7D-CLIP/S	S/Steel holding clips for F7-D Diffuser

Accessories - spare ballasts for YZ fittings		Emergency Accessories - for YZ fittings	
Code	Description	Code	Description
BYZ-18W	18 Watt Ballast	YZ-EMG-2X18	2x18W Emergency Ballast c/w Batteries
BYZ-36W	36 Watt Ballast	YZ-EMG-2X36	2x36W Emergency Ballast c/w Batteries
BYZ-58W	58 Watt Ballast	YZ-EMG-2X58	2x58W Emergency Ballast c/w Batteries
BYZ-2X18W	2 x 18 Watt Ballast	YZ-BAT	Battery for emergency fitting only
BYZ-2X36W	2 x 36 Watt Ballast		
BYZ-2X58W	2 x 58 Watt Ballast		

# T5 FLUORESCENT WEATHERPROOF FITTING IP65

**IP65 Weatherproof Light Fitting**  
 Supplied with electronic ballasts  
 Material: ABS Base & Polycarbonate diffuser  
 Working Temp: 85°C max



Lamp Power	Single Lamp			Twin Lamp		
	Code	c/w Emergency Kit	Size L x W x H	Code	c/w Emergency Kit	Size L x W x H
14W(2ft)	YZ-1T514W-ELC 240V	-	610 x 60 x 74mm	YZ-2T514W-ELC 240V	YZ-2T514W-EMG	610 x 60 x 74mm
28W(4ft)	YZ-1T528W-ELC 240V	YZ-1T528W-EMG	1210 x 60 x 74mm	YZ-2T528W-ELC 240V	YZ-2T528W-EMG	1210 x 60 x 74mm
54W(4ft)	YZ-1T554W-ELC 240V	YZ-1T554W-EMG	1210 x 60 x 74mm	YZ-2T554W-ELC 240V	YZ-2T554W-EMG	1210 x 60 x 74mm
35W(5ft)	YZ-1T535W-ELC 240V	YZ-1T535W-EMG	1510 x 60 x 74mm	YZ-2T535W-ELC 240V	YZ-2T535W-EMG	1510 x 60 x 74mm
49W(5ft)	YZ-1T549W-ELC 240V	YZ-1T549W-EMG	1510 x 60 x 74mm	YZ-2T549W-ELC 240V	YZ-2T549W-EMG	1510 x 60 x 74mm
80W(5ft)	YZ-1T580W-ELC 240V	YZ-1T580W-EMG	1510 x 60 x 74mm	YZ-2T580W-ELC 240V	YZ-2T580W-EMG	1510 x 60 x 74mm

For LED Tubes see page 3



## T8 LED STAINLESS STEEL LIGHT FITTING IP65

Material: 304 Stainless steel base & tempered glass diffuser.  
Working temperature: 120°C  
Application: Suitable for gas stations, chemical factories, etc.



Lamp Power	Size L x W x H	*Wired for LED	Spare Diffuser
1 x 8W (2FT)	710 x 140 x 97mm	LED-SS-8118A	SS-8118-DIF
1 x 18W (4FT)	1310 x 140 x 97mm	LED-SS-8136A	SS-8136-DIF
1 x 22W (5FT)	1610 x 140 x 97mm	LED-SS-8158A	SS-8158-DIF
2 x 8W (2FT)	710 x 210 x 97mm	LED-SS-8218A	SS-8218-DIF
2 x 18W (4FT)	1310 x 210 x 97mm	LED-SS-8236A	SS-8236-DIF
2 x 22W (5FT)	1610 x 210 x 97mm	LED-SS-8258A	SS-8258-DIF

\*Note: Lamps Excluded, For LED Tubes see page 1-3 | For Emergency Add Emergency Tube Code on Page 3

### Accessories

Code	Description
EL-FL	Fuse Link (To be Ordered Separately for LED Version)

For Polycarbonate diffuser add **-PCDIF** to code. For example: **SS-8258-PCDIF**

## T8 FLUORESCENT STAINLESS STEEL LIGHT FITTING IP65

Material: 304 Stainless steel base & tempered glass diffuser.  
Working temperature: 120°C  
Application: Suitable for gas stations, chemical factories, etc.



Lamp Power	Size L x W x H	Iron Ballast	Electronic Ballast (240V)	Electronic Ballast (110V)	Spare Diffuser
1 x 18W (2FT)	710 x 140 x 97mm	SS-8118A	SS-8118-ELC 240V	SS-8118-ELC 110V	SS-8118-DIF
1 x 36W (4FT)	1310 x 140 x 97mm	SS-8136A	SS-8136-ELC 240V	SS-8136-ELC 110V	SS-8136-DIF
1 x 58W (5FT)	1610 x 140 x 97mm	SS-8158A	SS-8158-ELC 240V	SS-8158-ELC 110V	SS-8158-DIF
2 x 18W (2FT)	710 x 210 x 97mm	SS-8218A	SS-8218-ELC 240V	SS-8218-ELC 110V	SS-8218-DIF
2 x 36W (4FT)	1310 x 210 x 97mm	SS-8236A	SS-8236-ELC 240V	SS-8236-ELC 110V	SS-8236-DIF
2 x 58W (5FT)	1610 x 210 x 97mm	SS-8258A	SS-8258-ELC 240V	SS-8258-ELC 110V	SS-8258-DIF

For Polycarbonate diffuser add **-PCDIF** to code. For example: **SS-8258-PCDIF**

## T8 LED ALUMINIUM FITTING IP65



F7118F



Wired for LED	Lamp Power	Size L x W x H
LED-F7118F	1 x 8W (2FT)	675 x 120 x 95mm
LED-F7218F	2 x 8W (2FT)	675 x 150 x 95mm
LED-F7136F	1 x 18W (4FT)	1285 x 120 x 95mm
LED-F7236F	2 x 18W (4FT)	1285 x 150 x 95mm
LED-F7158F	1 x 22W (5FT)	1585 x 120 x 95mm
LED-F7258F	2 x 22W (5FT)	1585 x 150 x 95mm

For lamps see Page 1-3 | For Emergency Add Emergency Tube Code on Page 3

### Accessories

Code	Description
NF7-CLIP/S	Spare Stainless Steel Clips
EL-FL	Fuse Link (To be Ordered Separately for LED Version)

For spare glass add **-DIF** to code. For example: **F7258F-DIF**

Material: Aluminium base and tempered glass cover. Stainless Steel Clips

## T8 FLUORESCENT ALUMINIUM FITTING IP65



F7118F



Iron Ballast	Elec. Ballast	Emerg. Ballast	Lamp Power	Size L x W x H
F7118F	F7118F-ELC	-	1 x 18W (2FT)	675 x 120 x 95mm
F7218F	F7218F-ELC	F7218F-EMG	2 x 18W (2FT)	675 x 150 x 95mm
F7136F	F7136F-ELC	-	1 x 36W (4FT)	1285 x 120 x 95mm
F7236F	F7236F-ELC	F7236F-EMG	2 x 36W (4FT)	1285 x 150 x 95mm
F7158F	F7158F-ELC	-	1 x 58W (5FT)	1585 x 120 x 95mm
F7258F	F7258F-ELC	F7258F-EMG	2 x 58W (5FT)	1585 x 150 x 95mm

For lamps see Page 19

For spare glass add **-DIF** to code. For example: **F7258F-DIF**

### Accessories

Code	Description
NF7-CLIP/S	Spare Stainless Steel Clips

Material: Aluminium base and tempered glass cover.

For T8 type lamps. Stainless Steel Clips

2 Year warranty on all LED products, unless otherwise specified. Warranty void if adequate surge protection is not installed on LED products. See page 147

**NEW**

# LED WEATHERPROOF LINEAR LIGHTING IP65

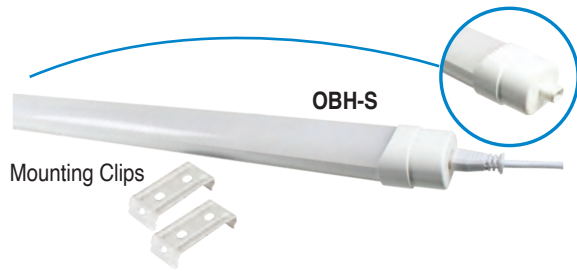

**LED Weatherproof Linear Light** - Input voltage: 230VAC | Extruded body | IK08 | RA > 80 | Mounting Kit Included | 400W max in series

Code	Wattage	Lumen	Size (mm)
<b>Ultra Slim - Linkable / PC Diffuser, Aluminium Body</b>			
OBH-S-18W-*	18W	1440lm	600 x 43 x 38
OBH-S-36W-*	36W	2880lm	1200 x 43 x 38
OBH-S-45W-*	45W	3840lm	1500 x 43 x 38

**Accessories**

Code	Description
OBH-MC	1m Middle Connector
OBH-PC	500mm Power Connector

Code	Wattage	Lumen	Size (mm)
<b>Standard Slimline - Quick Connect Power Adaptor</b>			
LG08C-06-18W-*	18W	1650lm	650 x 72 x 42
LG08C-12-36W-*	36W	3300lm	1250 x 72 x 42
LG08C-15-45W-*	45W	4000lm	1560 x 72 x 42

**High Power Slimline - With 230mm Fly Lead**

MDT-1701-SMD30-*	30W	2700lm	662 x 78 x 38
MDT-1702-SMD60-*	60W	5400lm	1232 x 78 x 38
MDT-1703-SMD70-*	70W	6300lm	1532 x 78 x 38

\*Add colour to code: ○ **CW** (Cool White) 4200K, ○ **DL** (Daylight) 6000K

**LED Weatherproof Linear Light** - Supply Voltage 100 - 240VAC | 2 x LED chip boards to ensure even lighting | Colour temp 6500K (Daylight) | PC Base and Lens | Aluminium heat sink | Series connection possible | Easy connection | Mounting Kit Included

Code	Wattage	Lumen	Size (mm)
RW-PK-WP60-1	9W	800lm	610 x 50 x 49
RW-PK-WP120-1	18W	1600lm	1210 x 50 x 49
RW-PK-WP150-1	22W	1900lm	1510 x 50 x 49

**LED Tri-Proof Fitting** - Input Voltage: 230VAC | 130lm/W | Colour Temperature: 6000K | Seamless Connection | c/w Surface Mounting Kit | c/w Waterproof End Cap | Suspension Kit Optional | Power-Connector not included

Code	Code	Wattage	Lumen	Size (mm)
<b>Standard - 2 Wire</b>				
<b>Dimmable</b>				
01TP-C2F-15	01TP-C2F-D-15	15W	1950lm	600 x 67 x 67
01TP-C4F-33	01TP-C4F-D-33	33W	4290lm	1200 x 67 x 67
01TP-C5F-45	01TP-C5F-D-45	45W	5850lm	1500 x 67 x 67

**Emergency - Lithium Ion | With Test Button | 4 Wire**

01TP-C2F-E-15	15W	1950lm (E-280lm)	600 x 67 x 67
01TP-C4F-E-33	33W	4290lm (E-460lm)	1200 x 67 x 67
01TP-C5F-E-45	45W	5850lm (E-560lm)	1500 x 67 x 67

**Accessories - 2 Wire & 4 Wire**

2 Wire Codes	Description	4 Wire Codes	Description
01TP-2W-PC	1m Power Connector	01TP-4W-PC	1m Power Connector
01TP-2W-JB	Seamless Joining Bracket	01TP-4W-JB	Seamless Joining Bracket
01TP-2W-JL	1m Jumper Lead	01TP-4W-JL	1m Jumper Lead
01TP-2W-MS	Microwave sensor	01TP-4W-MS	Microwave sensor

**INDUSTRIAL  
COMMERCIAL**
**LIGHTING**
**5 Year  
Warranty!**
**Standard  
2 Wire**
**O1TP  
Suspension Kit**

**Dimmable**
**Emergency**

1m Jumper Lead

1m Power Connector

Seamless Joining Bracket

Microwave Sensor

**NEW**

## LED WEATHERPROOF LINEAR LIGHTING IP65

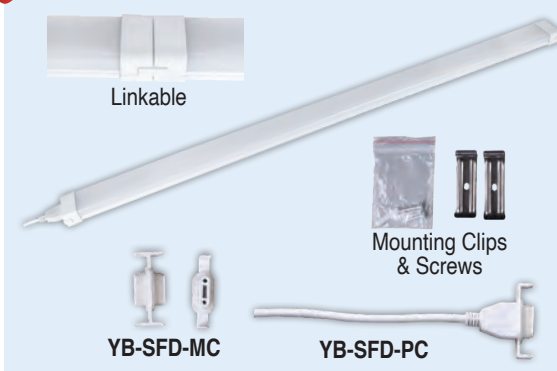

**LED Linear Light** - Input Voltage: 110-240VAC | Linkable | Easy Installation | c/w Mounting Clips, End Caps and 300mm Power Connector

Codes	Wattage	Lumen	Size (mm)
YB-SFD01-18W-*	18W	1500lm	600 x 60 x 29
YB-SFD01-36W-*	36W	3200lm	1200 x 60 x 29

\*Add Colour to Code: ○ CW (Cool White - 4200K), ○ DL (Day Light - 6000K)

Code (Accessories)	Description
YB-SFD-PC	300mm Power Connector
YB-SFD-MC	Middle Connector for Linking

**NEW**

## LED WEATHERPROOF LINEAR LIGHTING IP66

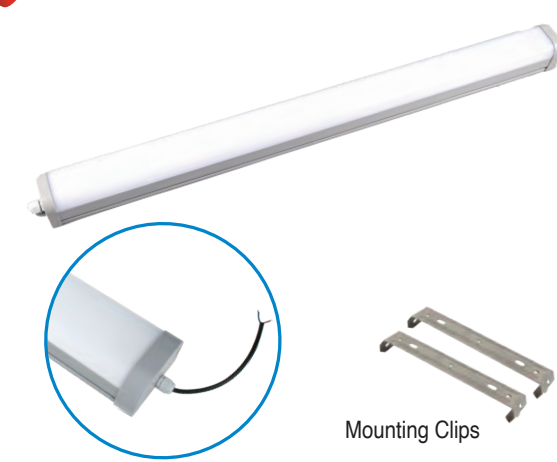

**Narrow Body** - Input Voltage: 230VAC | Integrated LED | CRI ≥80 | Material: PC | Mounting Clips Included | Supplied with 230mm Fly Lead

Code	Power	Lumens	Size (mm)
ZJT-0760-15W-*	15W	1425lm	600 x 70 x 65
ZJT-0790-20W-*	20W	1900lm	900 x 70 x 65
ZJT-07120-36W-*	36W	3600lm	1200 x 70 x 65
ZJT-07150-42W-*	42W	4200lm	1500 x 70 x 65

**Wide Body** - Input Voltage: 230VAC | Integrated LED | CRI ≥80

ZJT-1360-20W-*	20W	1900lm	600 x 134 x 61
ZJT-1390-30W-*	30W	2850lm	900 x 134 x 61
ZJT-13120-42W-*	42W	4200lm	1200 x 134 x 61

\*Add Colour to Code: ○ CW (Cool White - 4200K), ○ DL (Day Light - 6000K)

**NEW**

## LED LINEAR LIGHTING IP20



**LED T8 Batten** - Input Voltage: 220 - 240VAC | No Light Fitting Required | Easy Installation | Colour Temperature: 6000K (Daylight)

Code	Wattage	Lumen	Size (mm)
LEDT8-001A-9W-DL	9W	900lm	610 x 40 x 34
LEDT8-001A-18W-DL	18W	1800lm	1120 x 40 x 34
LEDT8-001A-2x9W-DL	2 x 9W	1800lm	610 x 84 x 34
LEDT8-001A-2x18W-DL	2 x 18W	3600lm	1120 x 84 x 34

Code (Accessories)	Description
W1023	1m Figure 8 Linking Cable

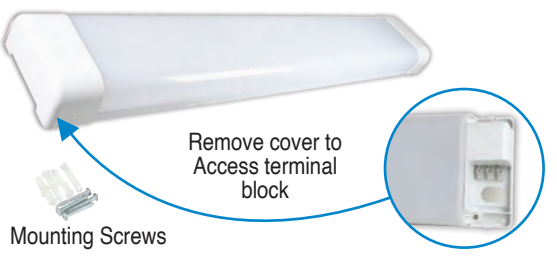

**LED Linear Light** - Input Voltage: 230 VAC | Aluminium body with PC diffuser | c/w Mounting Screws

Code	Wattage	Lumen	Size (mm)
GJZ-F10S-20W-*	20W	2000lm	675 x 108 x 45
GJZ-F10S-40W-*	40W	4000lm	1269 x 108 x 45

\*Add Colour to Code: ○ WW (Warm White 3000K), ○ CW (Cool White - 4200K), ○ DL (Day Light - 6000K)

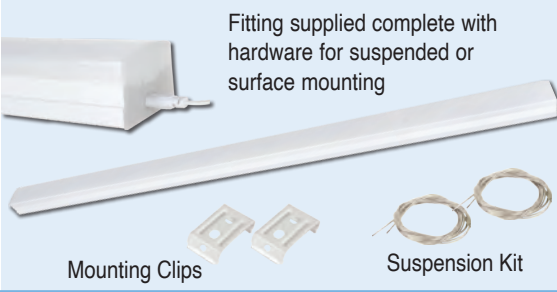

**LED Linear Light** - Colour Temperature: 4200K (Cool White) | Linkable | CRI >70

Code	Wattage	Lumens	Size (mm)
TDL-G45017-36-CW	36W	2880lm	1200 x 65 x 35

Accessories	
Code	Description
LC-1000	1m Figure 8 Linking Cable
LC-1500	1.5m Figure 8 Linking Cable

NEW

## LED LINEAR LIGHTING IP20



**Aluminium Linkable without Parabolic Reflector** - Input Voltage: 180 - 240VAC | 2 Part Design | Single or Interlink | Seamless Design | 120° Beam Angle | Frosted Diffuser

Code	Wattage	Lumens	Size (mm)
LINA-120-40-*	40W	5600lm	1190 x 57 x 67
LINA-150-60-*	60W	8400lm	1490 x 57 x 67

\*Add colour temp to code: ○ CW (Cool White - 4000K), ○ DL (Daylight - 6000K)

### Accessories

Code	Description
LIN1A-A	Middle Connector
LIN01-B	Suspension Kit, 2Pcs, 1 Meter Length
LINIA-R	Parabolic Reflector



**Linkable Linear** - Input Voltage: 100 - 265VAC | 120° Beam Angle | Aluminium body & PC Cover | Single or interlink | Seamless design | Supplied with Mounting Accessories

Code	Wattage	Lumens	Max Linkable Qty	Size (mm)
EVB-120-40-*	40W	5200lm	35	1200 x 73 x 55
EVB-150-60-*	60W	7800lm	28	1500 x 73 x 55

\* Add Colour Temperature to Code: ○ CW (4000K), ○ DL (6000K)

NEW

## ALUMINIUM LED LINEAR LIGHTS IP40



**LED Linear Light** - c/w 1m Suspension Kit and Linking Connector | Linkable

Code	XLN-1200-40W-*	XLN-1500-50W-*
Voltage	230VAC	230VAC
Power	36W	48W
Size (mm)	1200 x 54 x 85	1500 x 54 x 85
Lumen	3060	4080
CRI	80	80

\*Add colour to code: ○ CW (Cool White), ○ WW (Warm White)

**Aluminium Profile** - Empty | Ready to fit Strip Light

Code	Description	Code	Description
ALP052/2M	2m Aluminium Profile	ALP052-EC	End Cap with Hole
ALP052-FD	PC Diffuser Cover (Frosted)	ALP052-SW	2m Suspension Wire
ALP-LINK	Middle Connector to join two profiles		

(To make up complete set, order profile, diffuser, end cap & suspension wire)



**LED Linear Light** - 230VAC | c/w 1m Suspension Kit

Code	GL-LS3050-1200-*	GL-LS3050-1500-*	GL-LS3050-2400-*
Power	23W	28W	36W
Size (mm)	1200 x 38 x 60	1500 x 38 x 60	2400 x 38 x 60
Lumen	1800lm	2300lm	3600lm

\*Add colour to code: ○ WW (Warm White), ○ CW (Cool White)

Code (Accessories)	Description
GL-LS3050-WIRE	1m Suspension Kit
GL-LS3050-FLUSH	Surface Mount Bracket
GL-LS3050-LINK	Middle Connector to join two profiles

## BUTT JOINT LED PANEL LIGHT IP20



**Butt Joint LED Panel Light** - Input Voltage: 100-240VDC | Joinable Panels | Max Length 18m or 600W | Aero Metal Shell | Ultra Thin Height | Beam Angle: 110°

Code	Wattage	Lumens	Size (mm)
BQ-FPL-P300-*	10W	700lm	300 x 120 x 20
BQ-FPL-P600-*	20W	1400lm	600 x 120 x 20
BQ-FPL-P1200-*	40W	2800lm	1200 x 120 x 20

\* Add Colour Temperature to Code: ○ CW (4200K), ○ DL (5000K)

COMMERCIAL

LIGHTING

## LED LINEAR LIGHTING IP20

### LED Single Round Shape Pendant

- Supply voltage: AC 190-240V
- Material: Aluminium
- Power factor: PF > 0.9
- Beam angle: 145°
- Mounting Kit: Included

<b>Code</b>	<b>LD-PD-SR-18W</b>
Wattage	18W
Luminous Flux	1260lm
Colour Temperature	6000K (Pure White)



### LED Double Round Shape Pendant

- Supply voltage: AC 190-240V
- Material: Aluminium
- Power factor: PF > 0.9
- Beam angle: 145°
- Mounting Kit: Included

<b>Code</b>	<b>LD-PD-DR-36W</b>
Wattage	36W
Luminous Flux	2520lm
Colour Temperature	6000K (Pure White)



## LED CONNECTABLE LINEAR LIGHTING IP20

### LED Two-In-One Pendant Lighting -

Can be used as either an individual fitting or can be connected using the accessories below.

- Supply voltage: AC 190-240V
- Material: Aluminium
- Power factor: PF > 0.9
- Beam angle: 145°
- Mounting Kit: Included

<b>Code</b>	<b>LD-PD-EL-36W</b>
Wattage	36W
Luminous Flux	90lm/W
Colour Temperature	6000K (Pure White)



### Connectable Accessories



Code	LD-SC	LD-LC	LD-TC	LD-XC	LD-CB
Description	Straight connector 100 x 80 x 51mm	Left or Right bend 80 x 80 x 51mm	"T" Type connector 100 x 90 x 51mm	"+" Type connector 100 x 100 x 51mm	Spare connector block

NEW

3 Year Warranty!



## LED LINEAR LIGHTS

**Recessed Mount LED Linear Light IP20** - Input Voltage 230VAC | 120° Beam Angle | Aluminium & PC Cover | CRI > 80 | Connectable with various configurations | White Finish

Code	Wattage	Lumens	Size (mm)
<b>FX-LLR-60-20-*</b>	20W	2200lm	600 x 90 x 35
<b>FX-LLR-120-20-*</b>	40W	3800lm	1200 x 90 x 35

\*Add colour to code: ○ WW (Warm White 2700K) or ○ CW (Cool White 4200K)

### Connectors

Code	Description	Code	Description
<b>FX-LLR-SS</b>	Straight Connector	<b>FX-LLR-XC</b>	X Connector
<b>FX-LLR-L90</b>	90° Connector	<b>FX-LLR-IC90</b>	Inside 90° Connector
<b>FX-LLR-TC</b>	T Connector	<b>FX-LLR-OC90</b>	Outside 90° Connector

## LED OFFICE FIXTURE

**Linear Office Fixture** - Input Voltage 230VAC | Direct & Indirect Lighting | Linkable | Frameless LED Panel | UGR < 19 | High Lumen Efficiency | Magnetic Mounting Box for Quick Installation | Adjustable Colour Temp 3000K-4000K

Code	Wattage	Lumens	Size (mm)
<b>UP-PL35120-40</b>	40W	4800lm	1200 x 350 x 19
<b>UP-PL35120-60</b>	60W	7200lm	1200 x 350 x 19

NEW

ADJUSTABLE COLOUR TEMP.



NEW

## LED BATTEN IP20

Input Voltage: 230VAC | Mild Steel Body | Two Part for easy installation | c/w Mounting Screws

Code 2 Year	Code 5 Year	Wattage	Lumen	Size (mm)
<b>Standard Version - 100lm/W</b>				
LG05G-06-100-20-*	LG05G-5Y-06-100-20-*	20W	2000lm	630 x 75 x 85
LG05G-12-100-40-*	LG05G-5Y-12-100-40-*	40W	4000lm	1230 x 75 x 85
LG05G-15-100-60-*	LG05G-5Y-15-100-60-*	60W	6000lm	1518 x 75 x 85
<b>High-end Version - 125lm/W</b>				
LG05G-06-125-25-*	LG05G-5Y-125-25-*	25W	3125lm	630 x 75 x 85
LG05G-12-125-40-*	LG05G-5Y-125-40-*	40W	5000lm	1230 x 75 x 85

\*Add Colour to Code: ○ CW (Cool White - 4000K), ○ DL (Day Light - 6500K)



Profile View

Mounting Screws

Opening Clips

NEW

## SLIM LINE LED BATTEN IP20

**Ultra Slim Profile (Narrow Body)** - Input Voltage: 240VAC | High transparent opal diffuser | Easy to mount | Colour Temperature: 6000K | CRI: ≥80

Code	Wattage	Lumen	Size (mm) L x W x D
DY-30-10W	10W	900lm	300 x 75 x 24
DY-60-20W	20W	1800lm	600 x 75 x 24
DY-120-40W	40W	3600lm	1200 x 75 x 24

**High Power Ultra Slim Profile (Wide Body)** - Input Voltage: 240VAC | High transparent opal diffuser | Easy to mount | Colour Temperature: 6500K | CRI: ≥80

Code	Wattage	Lumen	Size (mm) L x W x D
OQ-XT-362	30W	2400lm	600 x 92 x 32
OQ-XT-721	72W	5760lm	1200 x 92 x 32
OQ-XT-961	96W	7680lm	1200 x 128 x 42



DY

OQ-XT

c/w mounting clips x2

NEW

## WALL OR CEILING LED FITTING IP20

Input Voltage 230VAC | 4200K (Cool White) | Aluminium with polypropylene diffuser

Code	Wattage	Lumen	Size (mm)
MB-075-LED-7W	7W	600lm	291 x 53 x 60
MB-075-LED-14W	14W	1200lm	552 x 53 x 60
MB-075-LED-21W	21W	1735lm	900 x 53 x 60
MB-075-LED-28W	28W	2380lm	1200 x 53 x 60

### Adjustable Wall Light

Input Voltage: 230VAC | Colour Silver | Adjustable Tilt | Material: Aluminium & PC cover with ABS End Caps | Colour Temperature: 4200K

Code	Wattage	Lumen	Size (mm)
RW-551-10	10W	700lm	555 x 36 x 75



Adjustable

## LINKABLE LED UNDERCOUNTER LIGHTING IP20

**LED Linear Light - 230VAC** - Tough plastic lens and body | Linkable c/w power cord and mounting accessories | Cool white (4000K)

Code	Wattage	Lumen	Size (mm)
RW-OC-T5-6W	6W	480-520lm	325 x 22 x 35
RW-OC-T5-10W	10W	870-920lm	586 x 22 x 35
RW-OC-T5-14W	14W	1120-1170lm	885 x 22 x 35
RW-OC-T5-18W	18W	1480-1530lm	1185 x 22 x 35

**Corner Mounting LED undercounter lighting** - 230VAC | 4200K (Cool White) | Linkable, c/w power cord and mounting accessories

Code	Wattage	Lumen	Size (mm)
LDL-5050-1	3W	308lm	303 x 62 x 21
LDL-5050-2	5W	528lm	441 x 62 x 21
LDL-5050-3	6W	638lm	576 x 27 x 11

**Linkable High output LED undercounter lighting** - 230VAC | Linkable c/w power cord and mounting accessories | Cool white (4000K) | Spare Linking Cable: **RS-T5-LINK**

Code	Wattage	Lumen	Size (mm)
RS-T5-9W	9W	750lm	600 x 24 x 30
RS-T5-18W	18W	1500lm	1200 x 24 x 30
RS-T5-24W	24W	2000lm	1500 x 24 x 30



Mounting Clips

Linking with no dark spots



COMMERCIAL

LIGHTING

## T5 & T8 LINEAR FITTINGS

**Wall/Ceiling Tri-Phosphor Fluorescent Fittings IP40** - Input Voltage: 230VAC | c/w Lamp | On/off Switch | Acrylic prismatic diffuser | Built-in electronic ballast | Lamp colour: Cool White.



Code	Lamp	Type	Size (mm)
NB5034-6W	6W	T5 (Linkable)	270 x 22 x 44
NB5034-8W	8W	T5 (Linkable)	345 x 22 x 44
NB5034-14W	14W	T5 (Linkable)	620 x 22 x 44
NB5034-28W	28W	T5 (Linkable)	1210 x 22 x 44
NB5002-18W	18W	T8	670 x 35 x 64
NB5002-36W	36W	T8	1280 x 35 x 64
NB5004-24W	24W	2G11 (NB5025)	430 x 104 x 42
NB5004-36W	36W	2G11 (NB5025)	525 x 104 x 42
NB5236-36W	36W	T8 (FLT8-36)	1280 x 104 x 42

**T5-Cabinet Light Fittings** - Input Voltage: 220-240V | Built-in electronic ballast | Lamps excluded. See page 19 for lamps



Code	Description	Size (mm)
GL-114	14W T5/G5 alum. housing with plastic cover	570 x 25 x 40
GL-121	21W T5/G5 alum. housing with plastic cover	880 x 25 x 40
GL-128	28W T5/G5 alum. housing with plastic cover	1180 x 25 x 40

Input Voltage: 220-240V | Built-in electronic ballast | c/w Lamps | Linkable

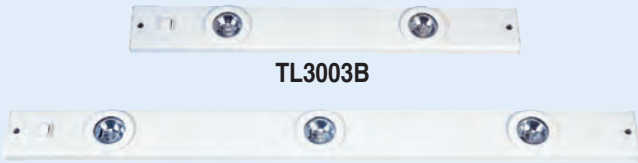

TL3003B

TL3004B

Code	Description	Size (mm)
TL3003B	Two Lamps 20W each, JC-12-20/G4 Lamp	550 x 70 x 25
TL3004B	Three Lamps 20W each, JC-12-20/G4 Lamp	825 x 70 x 25

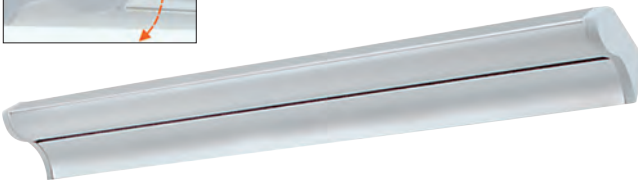
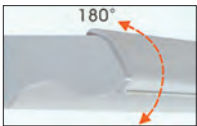

**Tiltable Wall Fluorescent Fitting** - Input Voltage: 230VAC | Lamp included | Lamp body in Aluminium | Acrylic diffuser. | End covers in ABS plastic | Lamp body finished in Matt Silver. | Lamp holder can be swivelled through 180° | Standard colour: Cool White

Code	Lamp	Type	Size (mm)
MB-056-8W	8W	T5	340 x 82 x 45
MB-056-21W	21W	T5	906 x 82 x 45

## OFFICE FIXTURES



LU-508



LU-509

**LED Light with Prismatic Diffuser** - Input Voltage: 100-240VAC | Colour Temp.: 6000K (Daylight) | LED tubes Included

Code	Wattage	Lumen	Size (mm)
LU-508-8W	8W	800lm	628 x 100 x 60
LU-508-18W	18W	1600lm	1238 x 100 x 60
LU-509-2X8W	2 x 8W	1600lm	628 x 164 x 60
LU-509-2X18W	2 x 18W	3400lm	1238 x 164 x 60
LU-509-2X22W	2 x 22W	3800lm	1538 x 164 x 60

**T8 Fluorescent Fittings with Diffuser & P.F. Capacitor. Electronic Ballast.**

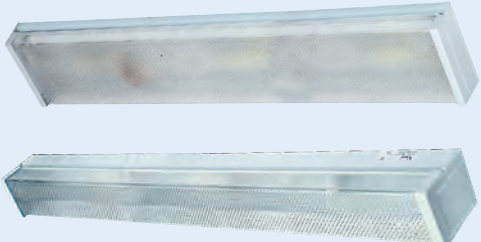

Single Lamp Code	Size (mm) L x W x H	Lamp Power	Twin Lamp Code	Size (mm) L x W x H
MX225-Y20	622 x 78 x 85	18W (2FT)	MX216B-Y20	628 x 176 x 65
MX325-Y30	935 x 78 x 85	30W (3FT)	MX316B-Y30	933 x 176 x 65
MX425-Y40	1240 x 78 x 85	36W (4FT)	MX416B-Y40	1238 x 176 x 65
MX625-Y58	1540 x 78 x 85	56W (5FT)	MX616B-Y58	1538 x 176 x 65

For spare diffuser add '-DIF' to end of code. Lamps excluded.

## OFFICE FIXTURES

LED

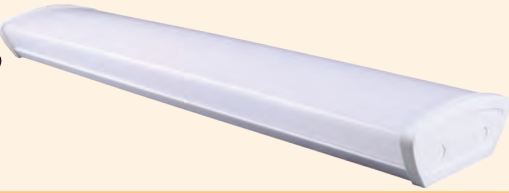

LED Fitting with Curved Opal Diffuser - Integrated LED

Code	Wattage	Lumens	Size (mm)
DW-LED-MX-18*	2 x 9W	1440lm	600 x 155 x 65
DW-LED-MX-36*	2 x 18W	2880lm	1200 x 155 x 65

\*Add Colour to Code: ○ CW (Cool White - 4200K), ○ DL (Day Light - 6000K)

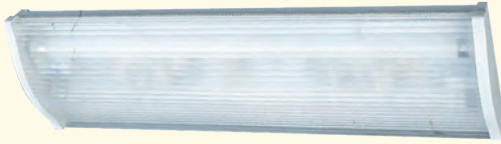

MX472

T8 Fluorescent Fittings with curved Opal Diffuser

Twin Lamp Code	Lamp Power	Size L x W x H
MX472-Y40	36W (4FT) x 2	1253 x 207 x 69mm

For spare diffuser add 'DIF' to end of code



MX472B

Fluorescent Fittings with curved Diffuser - Lamps Excluded | c/w Electronic Ballast

Twin Lamp Code	Lamp Power	Size L x W x H
MX472B-Y40	36W (4FT) x 2	1253 x 207 x 69mm

For spare diffuser add 'DIF' to end of code.

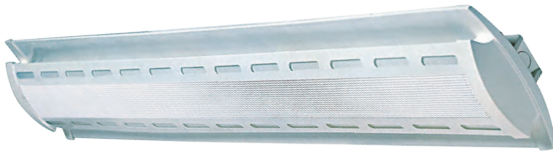

T8 Butterfly Surface Ceiling Fitting - c/w Electronic Ballast | White Powder Coated Steel Body | Lamps Excluded

Code	Wattage per Lamp	Lamp Type G13	Size (mm) L x W x H
MF-BF9258	58W	FLT8-58	1563 x 180 x 80 (5FT)



T8 Super Light Louvre Surface Ceiling Fitting - c/w Electronic Ballast | White Powder Coated Steel Body | Lamps Excluded

Code	Wattage	Lamp Type	Size (mm)
MF-SLM9240V	36W	FLT8-36	1265 x 295 x 85 (4FT)

## T8 OPEN CHANNEL FITTING - WIDE BODY

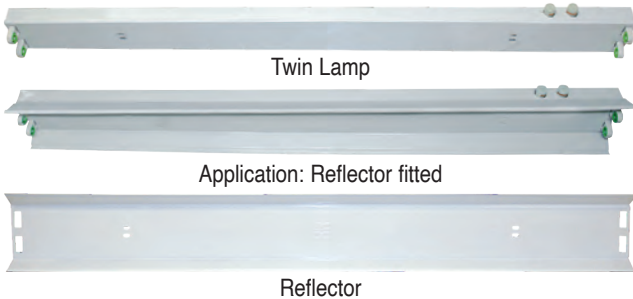

Wide Body Fitting - 100(W) x 38(H)mm

LED NEW	Fluorescent			Lamp Power	L (mm)
	Iron Ballast	Elec. Ballast	Reflector		
MF-3220-WB-LED	MF-3220-WB	MF-3220-WB-ELC	CZ-3220	2x18W(2FT)	630
MF-3230-WB-LED	MF-3230-WB	MF-3230-WB-ELC	CZ-3230	2x30W(3FT)	935
MF-3240-WB-LED	MF-3240-WB	MF-3240-WB-ELC	CZ-3240	2x36W(4FT)	1240
MF-3258-WB-LED	MF-3258-WB	MF-3258-WB-ELC	CZ-3258	2x58W(5FT)	1540

## TELESCOPIC OPEN CHANNEL FITTINGS

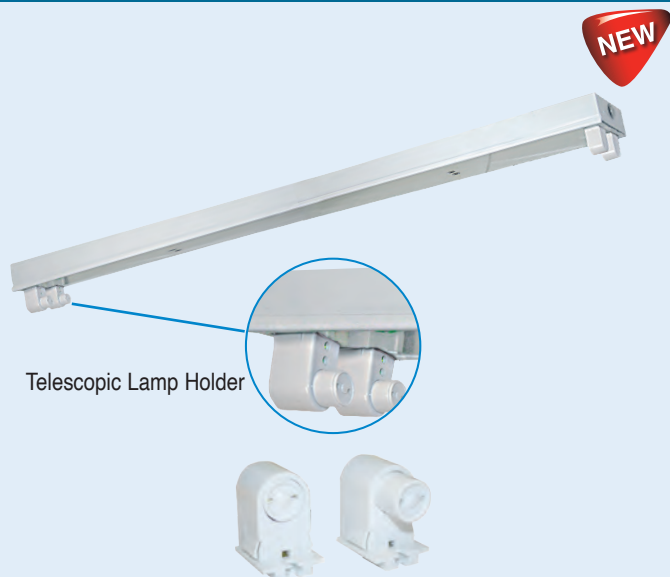

Wired for LED - Telescopic Open Channel Fitting | Telescopic Lampholders.

Single Lamp	Wattage	Twin Lamp	Wattage	Size
LED-TS-1X9	9W	LED-TS-2X9	2 x 9W	2FT (677mm)
LED-TS-1X18	18W	LED-TS-2X18	2 x 18W	4FT (1277mm)
LED-TS-1X22	22W	LED-TS-2X22	2 x 22W	5FT (1577mm)

Lamps Excluded - For LED Tubes see Page 1-3

Fluorescent - Telescopic Open Channel Fitting | Telescopic Lampholders.

Single Lamp	Size (mm)	Twin Lamp	Lamp Power	Size (mm)
Elec. Ballast		Elec. Ballast		
TS-6118	677 x 50 x 40	TS-6218	18W (2FT)	677 x 100 x 38
TS-6136	1277 x 50 x 40	TS-6236	36W (4FT)	1277 x 100 x 38
TS-6158	1577 x 50 x 40	TS-6258	58W (5FT)	1577 x 100 x 38

Lamps Excluded - For Fluorescent Tubes see Page 19

Accessories

Code	Description
PT-C01	Spare G13 lampholder per set



## T8 LED OPEN CHANNEL FITTING

Prewired Open Channel Fitting for T8 LED Tubes **LED Tubes & Fuse Links Excluded**

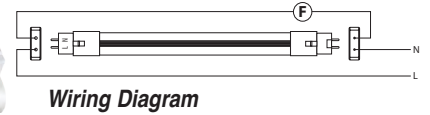
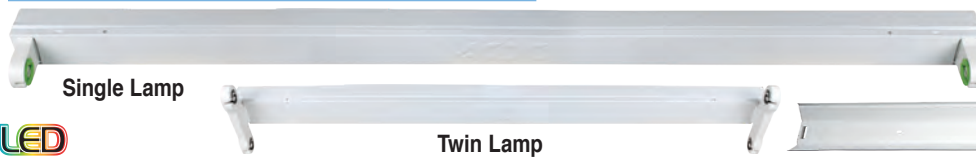

Reflector  
CZ-N3140

Lamp Power	Code (Fitting Only)				Size (mm)
	Single Lamp	Optional Reflector	Twin Lamp	Optional Reflector	
8W (2FT)	AL-A2	CZ-3120	AL-A2X2	CZ-N3220	624L x 35W x 31H
13W (3FT)	AL-A3	CZ-3130	AL-A3X2	CZ-N3230	928L x 35W x 31H
18W (4FT)	AL-A4	CZ-3140	AL-A4X2	CZ-N3240	1234L x 35W x 31H
22W (5FT)	AL-A5	CZ-3158	AL-A5X2	CZ-N3258	1534L x 35W x 31H

For LED tubes see page 1-3 | For Emergency Add Emergency Tube Code on page 3

### Slimline LED T8 Fitting

Prewired for LED

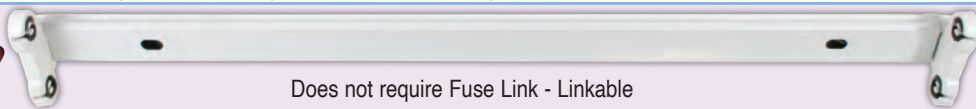

Does not require Fuse Link - Linkable



Side View

Lamp Power	Code (Fitting Only)		Size (mm)	Knock Out Size (mm)
	Single Lamp	Twin Lamp		
9W (2FT)	OS-LED-006	OS-LED-006-2	610 x 33 x 15	7 x 10
18W (4FT)	OS-LED-012	OS-LED-012-2	1210 x 33 x 15	7 x 10
22W (5FT)	OS-LED-015	OS-LED-015-2	1546 x 33 x 15	7 x 10

#### Accessories



Code	Description
LC-1000	1m Figure 8 Linking Cable
LC-1500	1.5m Figure 8 Linking Cable

For LED tubes see page 1-3 | For Emergency Add Emergency Tube Code on page 3

## T8 OPEN CHANNEL FLUORESCENT FITTINGS

### Open Fluorescent Fittings

c/w P.F. Capacitor



Reflector  
CZ-N3140

Lamp Power	Narrow Fitting 50(W) x 35(H)mm					Narrow Fitting 50(W) x 35(H)mm				
	Single Lamp					Twin Lamp				
	L (mm)	Iron Ballast	Elec. Ballast	c/w Emergency Kit	Reflector	L (mm)	Iron Ballast	Elec. Ballast	c/w Emergency Kit	Reflector
18W (2FT)	625	MF-3120	MF-3120-ELC	-	CZ-3120	630	MF-3220	MF-3220-ELC	-	CZ-N3220
30W (3FT)	930	MF-3130	MF-3130-ELC	*MF-3130-EMG	CZ-3130	932	MF-3230	MF-3230-ELC	*MF-3230-EMG	CZ-N3230
36W (4FT)	1240	MF-3140	MF-3140-ELC	*MF-3140-EMG	CZ-3140	1235	MF-3240	MF-3240-ELC	*MF-3240-EMG	CZ-N3240
58W (5FT)	1540	MF-3158	MF-3158-ELC	*MF-3158-EMG	CZ-3158	1535	MF-3258	MF-3258-ELC	*MF-3258-EMG	CZ-N3258

\*1 Lamp fitted with Emergency Kit @ 11% of full power for 1 hour @ 58W

For dimmable light fitting add 'dim' to part No. eg. MF-3140-DIM. Note dimmable units to work with correct external dimmer module EP1 / DS2F see page 158



Accessories - For spare ballasts see page 157-159

Code	Description
PT-C07	Spare lampholder for twin-lamp fittings
PT-C02	Spare lampholder for single-lamp fittings

## T5 OPEN CHANNEL FLUORESCENT FITTINGS

Open Fluorescent Fittings - Supplied with electronic ballasts

Double Lamp

Single Lamp



Lamp Power	Single Lamp			Twin Lamp		
	Code	c/w Emergency Kit	Size L x W x H	Code	c/w Emergency Kit	Size L x W x H
14W(2ft)	MF-5114-ELC 240V	-	579 x 50 x 70mm	MF-5214-ELC 240V	-	579 x 50 x 70mm
21W(3ft)	MF-5121-ELC 240V	-	879 x 50 x 70mm	MF-5221-ELC 240V	MF-5221-EMG	879 x 50 x 70mm
28W(4ft)	MF-5128-ELC 240V	MF-5128-EMG	1179 x 50 x 70mm	MF-5228-ELC 240V	MF-5228-EMG	1179 x 50 x 70mm
35W(5ft)	MF-5135-ELC 240V	MF-5135-EMG	1479 x 50 x 70mm	MF-5235-ELC 240V	MF-5235-EMG	1479 x 50 x 70mm
24W(2ft)	MF-5124-ELC 240V	-	579 x 50 x 70mm	MF-5224-ELC 240V	-	579 x 50 x 70mm
54W(4ft)	MF-5154-ELC 240V	MF-5154-EMG	1179 x 50 x 70mm	MF-5254-ELC 240V	MF-5254-EMG	1179 x 50 x 70mm
49W(5ft)	MF-5149-ELC 240V	MF-5149-EMG	1479 x 50 x 70mm	MF-5249-ELC 240V	MF-5249-EMG	1479 x 50 x 70mm

2 Year warranty on all LED products, unless otherwise specified. Warranty void if adequate surge protection is not installed on LED products. See page 147

NEW

# LED RECESSED PANELS IP40

3 Year Warranty!

P0606

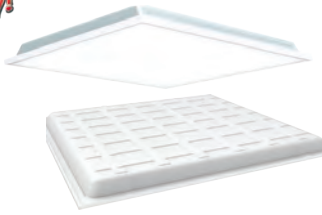

**Backlit Panel** - Input Voltage: 100-240VAC | High Quality | Ultra Efficient | Low Glare | PMMA Diffuser | Suspension Kit available under Accessories

Code 3 Year	Wattage	Lumen	Size (mm)	Spare Driver
DFL-P0606-40W-*	40W	4400lm	595 x 595 x 30	DRV-DFL-40W-B
DFL-P0606-64W-*	64W	7040lm	595 x 595 x 30	DRV-DFL-64W-B
DFL-P1203-40W-*	40W	4000lm	1195 x 300 x 30	DIM-DFL-40W
DFL-P1206-64W-*	64W	7040lm	1195 x 595 x 30	DRV-DFL-64W-B

\* Add colour to code: ○ CW (Cool White) 4200K, ○ DL (Daylight) 6000K

3 Year Warranty!



**Side LED**- 3 Year Warranty panels are designed for normal operating conditions at 8hrs a day. It is recommended to use the 5 Year Warranty panels for operating hours above 8hrs. Warranty void if panels are incorrectly specified for the application.

Code	Wattage	Lumen	Size (mm)	Spare Driver
<b>Standard</b> - Supply Voltage: 100-240VAC   CRI > 80   Lumen Output 100lm/W				
DFL-P0303-*	21W	2100lm	300 x 300 x 12	DRV-DFL-21W
DFL-P0606-46W-CW	46W	4600lm	595 x 595 x 12	DRV-DFL-46W
DFL-P0606-72W-*	72W	7200lm	595 x 595 x 12	DRV-DFL-0606-72W
DFL-P1203-DL	52W	5200lm	1195 x 300 x 12	DRV-DFL-52W

**Dimmable** - Supply Voltage: 100-240VAC | Panels have a 1-10V input on driver (use GL-CA-1 Dimmer)

Code	Wattage	Lumen	Size (mm)	Spare Driver
DIM-DFL-P0303-*	21W	2100lm	300 x 300 x 12	DIM-DRV-DFL-21W
DIM-DFL-P1203-*	52W	5200lm	1195 x 300 x 12	DIM-DRV-DFL-52W
DIM-DFL-P1206-72W-*	72W	7200lm	1195 x 595 x 12	DIM-DRV-DFL-1206-72W

\*Add colour to code: ○ CW (Cool White) 4200K, ○ DL (Daylight) 6000K

5 Year Warranty!



125lm/W

**High Performance** - Input Voltage: 100-277VAC | High Quality, Optimal Performance | CRI > 80 | Lumen Output 125lm/W | Flicker Free | Light Guide Plates PMMA | PF 0.95 | IP20

Codes	Wattage	Lumen	Size (mm)	Spare Driver
FN-0606-40W-*	40W	5000lm	595 x 595 x 10	DRV-FN-40W
FN-60120-50W-*	50W	6250lm	595 x 1195 x 10	DRV-FN-50W

\* Add colour to code: ○ CW (Cool White) 4200K, ○ DL (Daylight) 6000K

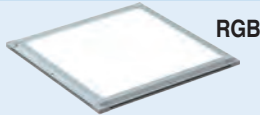

RGB



c/w Remote

**RGB** - Supply Voltage: 100-240VAC | RGB | c/w Remote

Codes	Wattage	Lumen	Size (mm)	Spare Driver
DFL-P0606-46W-RGB	46W	3220lm	595 x 595 x 50	DRV-DFL-46W-RGB

Dimmer



GL-CA-1



SF-300



GL-CA-4KIT  
GL-CA-6KIT



SM4-6060

SM4-60120

### Accessories

Code	Description
SF-300	2m 0.75 x 3 Core Cable with 5Amp Plug
GL-CA-4KIT	4 Pcs of wire for 300x300 or 600x600 panels
GL-CA-6KIT	6 Pcs of wire for 1200x300 or 1200x600 panels
GL-CA-1	Up to 144W (230VAC)   1-10V Output (No Max Load)
SM4-6060	595 x 595 x 10mm Surface Mount Bracket for LED Panel
SM4-60120	595 x 1195 x 10mm Surface Mount Bracket for LED Panel
DFL-4H	Suspension bracket for 600x600 backlit panel
DFL-6H	Suspension bracket for 1200x600 backlit panel

2 Year Warranty!



**Daylight Harvesting** - Input Voltage: 100-277VAC | Beam Angle 80° | UGR 19 | CRI > 80 | Built in daylight sensor to sense movement & calculate ambient light to automatically adjust light output to set parameters.

Code	Wattage	Lumen	Size (mm)
PL-0606-*	40W	3790lm	595 x 595 x 44

\* Add colour to code: ○ CW (Cool White) 4200K, ○ DL (Daylight) 6000K

### Accessories

Code	Description
PL-RMC	Remote Control for setting Parameters



GL-42-R\*

2 Year Warranty!



GL-42-S\*

**Decorative Recessed LED Panel** - Input Voltage: 230VAC | Body Construction ABS | Opal Diffuser | White Trim Colour | CRI: +80 | IP20

Code	Wattage	Lumen	Size (mm)	Inner Shape
GL-42-R-*	42W	4368lm	595 x 595 x 100	Round
GL-42-S-*	42W	4368lm	595 x 595 x 100	Square

\* Add colour to code: ○ CW (Cool White) 4200K, ○ DL (Daylight) 6000K

NEW

## LED RECESSED PANELS

2 Year  
Warranty!



**LED Emergency Panel IP40** - Input Voltage: 230VAC | 1hr Backup time - Half power during backup | Green light - Main line, Red light - Charging, Yellow light - Error | Ni-MH Rechargeable battery

Codes	Wattage	Lumens	Size (mm)
EMG-DFL-P0606-40W-*	40W	4000lm	595 x 595
EMG-DFL-P1206-60W-*	50W	5000lm	1195 x 595

\*Add colour to code: ○ CW (Cool White 4200K), ○ DL (Daylight 6500K)

**Antibacterial LED Panel IP65** - Input Voltage: 230VAC | 120° Beam Angle | Aluminium + PMMA | Low Glare <19 | Dust and Waterproof | Applications: Hospital, Clean Room, Pharmaceutical Factory, Operating Room, Food Facilities. | A particular photocatalytic coating on the LED panel light ensures that bacteria and viruses that come in contact with the surface of the panel for a short period of time can be rendered harmless.

Code	Wattage	Lumens	Size (mm)
ABPC-6060-36-*	36W	3600lm	595 x 595

\*Add colour to code: ○ CW (Cool White 4200K), ○ DL (Daylight 6000K)

**Germicidal LED Panel IP44** - Input Voltage: 230VAC | Antistatic treated to avoid dust build up | Spectrum of light does not produce ultraviolet or blue light | Ideal for hospital, pharmaceutical, clean room, laboratories and food produce factories.

Code	Wattage	Lumens	Spectrum	Size (mm)
DFL-UVC-6060-40	40W+20W	4000lm	UVA + UVC	595 x 595 x 12
DFL-UVC-1203-40	40W+20W	4000lm	UVA + UVC	295 x 1195 x 12

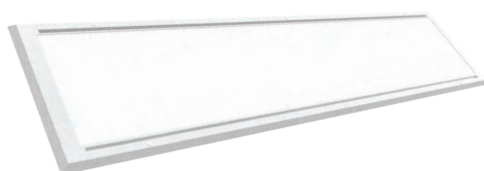

NEW

## LED RECESSED FITTINGS

5 Year  
Warranty!

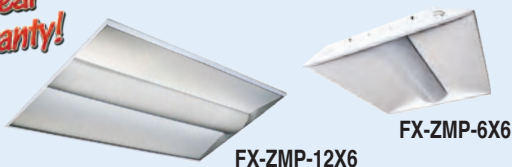

**Recessed Indirect Fitting** - Input Voltage: 85-265VAC | Integrated LEDs

Codes	Wattage	Lumens	Size (mm)
FX-ZMP-6X6-*	46W	4600lm	595 x 595 x 95
FX-ZMP-12X3-*	53W	5300lm	1195 x 295 x 95
FX-ZMP-12X6-*	53W	5300lm	1195 x 595 x 95

\*Add colour to code: ○ CW (Cool White 4200K), ○ DL (Daylight 6500K)

LED Tubes & Fuse Links Excluded

**Recessed Fittings with Prismatic Diffuser** - Wired for T8 LED tubes

Code	No. of Lamps/ Power	Size (mm) L x W x H
LED-66123	3 x 2FT	595 x 595 x 90
LED-66123P4	4 x 2FT	595 x 595 x 90
LED-66143	3 x 4FT	595 x 1195 x 90
LED-66143P4	4 x 4FT	595 x 1195 x 90

For LED tubes see page 1-3 | For Emergency Add Emergency Tube Code on page 3

LED Tubes & Fuse Links Excluded

**Recessed Fittings Aluminium Parabolic Louvre** - Wired for T8 LED tubes

LED-8123P3	3 x 2FT	595 x 595 x 90
LED-8123P4	4 x 2FT	595 x 595 x 90
LED-8143P3	3 x 4FT	595 x 1195 x 90
LED-8143P4	4 x 4FT	595 x 1195 x 90

NEW

## LED T8 SURFACE FITTINGS

LED-ETL320VG



**LED T8 Steel Surface Mount IP20** - V-Shaped Louvre Grill | c/w Fuse Links | Pre-wired for LED Tube

Code	T8 Lamp	Size (mm)
LED-ETL320VG	2 x 9W	660 x 425 x 68
LED-ETL240VG	2 x 18W	1250 x 303 x 68

LED-ETL240VG

## T8 RECESSED FLUORESCENT FITTINGS

**Recessed Fittings Aluminium Parabolic Louvre c/w P.F. Capacitor -**  
Emergency Kit fitted @ 12% of full power for 3 hours @ 36W | Lamps excluded |  
Hinged Reflector for easy maintenance

Code	No. of Lamps/ Power	Size (mm) L x W x H	1 Lamp fitted with EMG kit
SF-8123P3* *	3 x 18W (2FT)	595 x 595 x 90	SF-8123P3-EMG
SF-8123P4*	4 x 18W (2FT)	595 x 595 x 90	SF-8123P4-EMG
SF-8143P3* *	3 x 36W (4FT)	595 x 1195 x 90	SF-8143P3-EMG
SF-8143P4*	4 x 36W (4FT)	595 x 1195 x 90	SF-8143P4-EMG

\*For electronic ballast add **-ELC**. \* For 2m cord set add **SF** to code

Accessories Code	Description
SF-300	2 meter 0.75 x 3 core cable with 5 Amp Plug
SF-305	3 meter 0.75 x 3 core cable with 5 Amp Plug
SF-304	Assembly of 2 meter cable to light fitting
SF-8143P3-DIF	Spare 1200 x 600 Aluminium Parabolic Reflector
SF-8143P4-DIF	Spare 1200 x 600 Aluminium Parabolic Reflector
PT-C08	Lampholder



Spare Reflector



SF-300



PT-C08

**Recessed Fittings Prismatic Diffuser c/w P.F. Capacitor -** Emergency Kit  
fitted @ 12% of full power for 3 hours @ 36W | Lamps excluded.

Code	No. of Lamps/ Power	Size (mm) L x W x H	1 Lamp fitted with EMG kit
SF-66123*	3 x 18W (2FT)	595 x 595 x 90	SF-66123-EMG
SF-66123P4*	4 x 18W (2FT)	595 x 595 x 90	SF-66123P4-EMG
SF-66143*	3 x 36W (4FT)	595 x 1195 x 90	SF-66143-EMG
SF-66143P4*	4 x 36W (4FT)	595 x 1195 x 90	SF-66143P4-EMG

\*For electronic ballast add **-ELC**

Accessories Code	Description
SF-300	2 meter 0.75 x 3 core cable with 5 Amp Plug
SF-304	Assembly of 2 meter cable to light fitting
SF-66123-DIF	Spare 600 x 600 Prismatic Diffuser
SF-66143-DIF	Spare 1200 x 600 Prismatic Diffuser
PT-C08	Lamp Holder

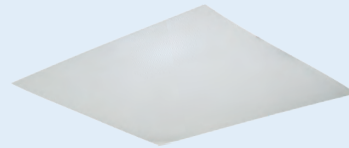
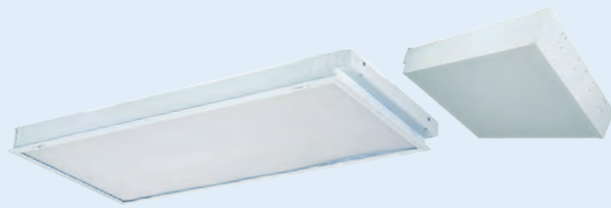

Spare Diffuser



SF-300



PT-C08

## T5 RECESSED FLUORESCENT FITTINGS

**T5 Recessed Double Parabolic Light Fittings** With Electronic Ballasts | Lamps Excluded

Size (mm) L x W x H	Code 2 Lamp	Code 3 Lamp		Code 4 Lamp	Wattage per Lamp	Lamp Type G5
		Normal	90min Emergency			
600 x 600 x 60	-	-	-	SK-T5L414	14W	FLT5-14
1200 x 295 x 60	T5-T1142R	-	-	-	28W	FLT5-28
1200 x 600 x 60	SK-T5L228	SK-T5L328	SK-T5L328-EMG	-	28W	FLT5-28
1200 x 600 x 60	-	SK-T5L354	-	-	54W	FLT5-54

**Accessories**

Code	Description
SK-T5L228-DIF	Spare Aluminium Louvre for <b>SK-T5L228</b>
SK-T5L314-DIF	Spare Aluminium Louvre for <b>SK-T5L314</b>
SK-T5L328-DIF	Spare Aluminium Louvre for <b>SK-T5L328</b>
SF-300	2 Meter 0.75 x 3 Core Cable with Samp Plug
SF-305	3 Meter 0.75 x 3 Core Cable with Samp Plug
SF-304	Assembly of 2 Meter Cable to Light Fitting

**Recessed Fitting -** White | With Electronic Ballast 230VAC | Double reflector system  
provides soft and glare-free lighting | Energy saving | Elegant and modern design | Lamps excluded.  
For Lamps see page 19

Code	No. of Lamps/Power	Size (mm) L x W x H
TCH-214	2 x 14W	595 x 595 x 90
TCH-220	2 x 28W	1195 x 595 x 90



SK-T5L328  
SK-T5L354

SK-T5L228

SK-T5L314

T5-T1142R



## RECESSED PLL FITTINGS



**PLL Recessed Parabolic Light Fittings** c/w Electronic Ballasts for 2 x 55W(2G11)  
| Elec. Transformer 230/12V 150VA for 3 x AR111 (included) | Lamps Excluded

Size (mm) L x W x H	2 x 55W (T5) 3 x AR111	Lamp Type 2G11
600 x 600 x 60	SF-0755G	NB5025-55

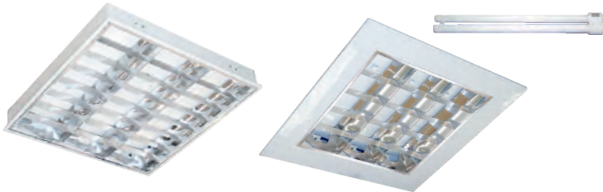

**PLL Recessed Parabolic Fitting** c/w Electronic Ballast | Lamps Excluded

Size (mm) L x W x H	Code 3 Lamp	Wattage per Lamp	Lamp Type 2G11
595 x 595 x 90	SF-366-ELC	36W	NB5025-36
595 x 595 x 85	SF-8355	55W	NB5025-55



**PLL Recessed Glider Fitting** c/w Magnetic Ballast | Lamps Excluded

Size (mm) L x W x H	Code 3 Lamp	Wattage per Lamp	Lamp Type 2G11
595 x 595 x 111	SF-86236V	36W	NB5025-36

## T8 SURFACE FLUORESCENT FITTINGS

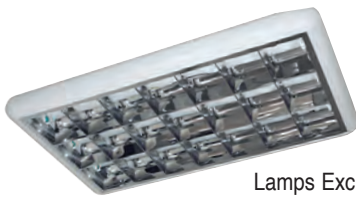

Lamps Excluded

**T8 Steel Surface Ceiling Light Fitting** c/w Electronic Ballasts | V-Shaped Louvre Grill

Size (mm) L x W x H	Code 3 Lamp	Wattage per Lamp	Lamp Type G13
695 x 425 x 68 (2FT)	SK-ETL320VG	18W	FLT8-18

## T5 SURFACE FLUORESCENT FITTINGS

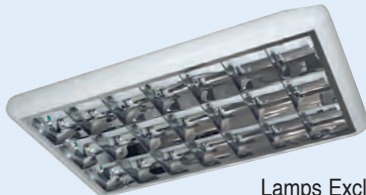

Lamps Excluded

**T5 Steel Surface Ceiling Light Fitting** c/w Electronic Ballasts | V-Shaped Louvre Grill

Size (mm) L x W x H	Code 3 Lamp	Wattage per Lamp	Lamp Type G5
660 x 425 x 68 (2FT)	SK-ETL314VG	3 x 14W	FLT5-14

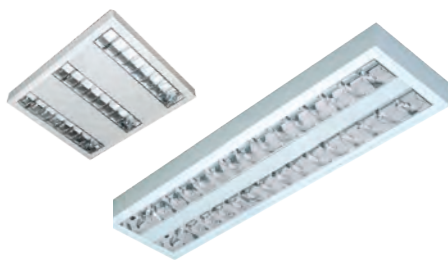

**T5 Surface Double Parabolic Light Fittings** With Electronic Ballasts | Lamps Excluded

Size (mm) L x W x H	Code 2 Lamp	Code 3 Lamp	Wattage per Lamp	Lamp Type G5
600 x 600 x 60	-	MF-T5314	14W	FLT5-14
1200 x 295 x 60	T5-T1142S	-	28W	FLT5-28
1200 x 295 x 60	T5-T254S	-	54W	FLT5-54

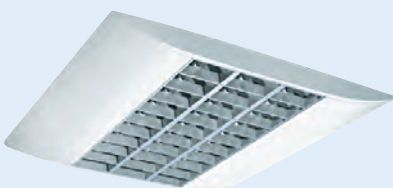

**T5 Surface Fluorescent Louvre** With Electronic Ballasts | Lamps Excluded

Size (mm) L x W x H	Code 3 Lamp	Wattage per Lamp	Lamp Type G5
623 x 623 x 66	SK-STL314	14W	FLT5-14
1227 x 623 x 66	SK-STL328	28W	FLT5-28
1227 x 623 x 66	SK-STL354	54W	FLT5-54

## SURFACE PLL FLUORESCENT FITTINGS



**PLL Owl Surface Ceiling Fitting** c/w Magnetic Ballast | Lamps excluded. For lamps see page 19

Size (mm) L x W x H	Code 2 Lamp	Wattage per Lamp	Lamp Type 2G11
585 x 550 x 64	MF-OW236	36W	NB5025-36

# RECESSED LED DOWNLIGHTS

Dimmable

- WW - 2700K
- CW - 4200K
- PW - 5000K

**5 Year Warranty!**



**Super Slim Design IP54** - Input Voltage: 230VAC | Triac Dimmable | CRI ≥ 80 | Class II Protection | IK06 Rating | Material PC / Aluminium | Lifetime 50 000hrs | Operating Temp: -20°C - 45°C

Code	Wattage	Lumens (lm)	Cut out Size (mm)	Size (mm)	Beam Angle	*Add Colour to Code
UP-DL210-10W-*	10W	760 - 870	Ø90 - 95	Ø110 x 30	90°	WW / CW / PW
UP-DL210-13W-*	13W	1020 - 1140	Ø120 - 130	Ø145 x 30	90°	WW / CW / PW
UP-DL210-18W-*	18W	1620 - 1800	Ø160 x 170	Ø190 x 30	90°	WW / CW / PW
UP-DL210-25W-*	25W	2130 - 2380	Ø200 x 210	Ø225 x 34	90°	WW / CW / PW

- WW - 2700K
- CW - 4200K
- PW - 5000K

**5 Year Warranty!**



**Deep Reflector IP54** - Input Voltage: 230VAC | Triac Dimmable | CRI ≥ 80 | Class II Protection | IK06 Rating | Material PC / Aluminium | Lifetime 50 000hrs | Operating Temp: -20°C - 45°C

Code	Wattage	Lumens (lm)	Cut out Size (mm)	Size (mm)	Beam Angle	*Add Colour to Code
UP-DL179-10W-*	10W	700 - 800	Ø90 x 95	Ø110 x 54	80°	WW / CW / PW
UP-DL179-18W-*	18W	1600 - 1800	Ø125 x 135	Ø145 x 78	80°	WW / CW / PW
UP-DL179-25W-*	25W	2300 - 2550	Ø150 x 165	Ø172 x 90	80°	WW / CW / PW

- WW - 2700K
- CW - 4200K
- PW - 5000K

**5 Year Warranty!**



**COB High Power IP54** - Input Voltage: 230VAC | Triac Dimmable | CRI ≥ 80 | Class II Protection | IK06 Rating | Aluminium Reflector + Tempered Glass Lens | Lifetime 50 000hrs | Operating Temp: -20°C - 40°C

Code	Wattage	Lumens (lm)	Cut out Size (mm)	Size (mm)	Beam Angle	*Add Colour to Code
UP-DL229-10W-*	10W	760 - 988	Ø90 - 95	Ø110 x 35	60°	WW / CW / PW
UP-DL229-18W-S-*	18W	1500 - 1997	Ø120 - 130	Ø145 x 65	60°	WW / CW / PW
UP-DL229-18W-L-*	18W	1600 - 2066	Ø200 - 210	Ø225 x 87	60°	WW / CW / PW
UP-DL229-25W-*	25W	2200 - 2801	Ø200 - 210	Ø225 x 87	60°	WW / CW / PW
UP-DL229-42W-*	42W	3050 - 3659	Ø200 - 210	Ø225 x 87	60°	WW / CW / PW

- CW - 4200K
- PW - 5000K

**5 Year Warranty!**



**Gimble Head IP20** - Input Voltage: 230VAC | Triac Dimmable | CRI ≥ 80 | Class II Protection | IK06 Rating | PC Reflector + Tempered Glass | Lifetime 50 000hrs | Operating Temp: -20°C - 40°C

Code	Wattage	Lumens (lm)	Cut out Size (mm)	Size (mm)	*Beam Angle	*Add Colour to Code
UP-DL77-10W-*-*	10W	700 - 800	Ø85 - 90	Ø96 x 68	15, 24	CW / PW
UP-DL77-20W-*-*	20W	1840 - 2100	Ø120 - 130	Ø145 x 102	36, 60	CW / PW
UP-DL77-35W-*-*	35W	3350 - 3800	Ø165 - 170	Ø180 x 128.5	45, 60	CW / PW

- WW - 2700K
- CW - 4200K



**White / Silver Trim Downlight** - Input Voltage: 100-240VAC | Ultra Thin | Beam Angle 110° | Triac Dimmable

Code	Wattage	Lumens	Cut out Size (mm)	Material/ Colour	Size (mm)	*Add Colour to Code
GL-P9WA-*-*	9W	720lm	Ø135	White/Silver	145Ø x 14	WW / CW
GL-P12WA-*	12W	960lm	Ø155	Silver	170Ø x 14	WW / CW
GL-P16WA-*	16W	1280lm	Ø185	Silver	200Ø x 14	WW / CW
GL-P20WA-*	20W	1600lm	Ø210	Silver	220Ø x 14	WW / CW

\*Add WH to code for white trim

- WW - 2700K
- CW - 4200K
- DL - 6000K



**Glass Trim Downlight** - Input Voltage: 100-240VAC | Beam Angle 110° | Triac Dimmable

DIM-DL-RN100-6W-*	6W	400lm	Ø75	White	Ø100 x 28	WW / CW / DL
DIM-DL-RN160-12W-*	12W	800lm	Ø120	White	Ø160 x 30	WW / CW / DL

Input Voltage: 230VAC | Beam Angle: 90° | TRIAC Dimming

- WW - 2700K
- CW - 4200K



Code	Wattage	Lumens	Cut out Size (mm)	Material/ Colour	Size (mm)	*Add Colour to Code
HI-015-6W-*	6W	510lm	Ø120	White	Ø145 x 74	WW / CW
HI-015-12W-*	12W	1020lm	Ø120	White	Ø145 x 74	WW / CW
HI-015-15W-*	15W	1300lm	Ø120	White	Ø145 x 74	WW / CW

COMMERCIAL

LIGHTING

## SURFACE MOUNT LED DOWNLIGHTS

### Non-Dimmable

- WW - 2700K
- CW - 4200K

- \*W - White
- \*B - Black



Input Voltage: 85-265VAC | Aluminium | Beam Angle: 45°

Code	Wattage	Lumens	Cut out Size (mm)	Material/Colour	Size (mm)	*Add Colour to Code
COB-SM*-10W-*	10W	800lm	-	*W / B	Ø90 x 124	WW / CW
COB-SM*-20W-*	20W	1300lm	-	*W / B	Ø115 x 145	WW / CW
COB-SM*-30W-*	30W	1950lm	-	*W / B	Ø149 x 165	WW / CW

SM-RN



Input Voltage: 85-265VAC | Back Lit | Beam Angle: 140°

SM-RN120-6W-*	6W	420lm	-	White	Ø123 x 35	WW / CW
SM-RN170-12W-*	12W	960lm	-	White	Ø174 x 35	WW / CW
SM-RN225-18W-*	18W	1620lm	-	White	Ø226 x 35	WW / CW
SM-SQ120-6W-*	6W	420lm	-	White	122 x 122 x 35	WW / CW
SM-SQ172-12W-*	12W	960lm	-	White	173 x 173 x 35	WW / CW
SM-SQ225-18W-*	18W	1620lm	-	White	226 x 226 x 35	WW / CW



SM-SQ

NEW

## 2 IN 1 SURFACE AND RECESSED LED DOWNLIGHTS

### Non-Dimmable

- WW - 2700K
- CW - 4200K
- DL - 6000K



**Motion & Daylight Sensor LED Panel** - Input Voltage: 230VAC | Detection Height 3,5m | Hold Time 30s | Moon Mode: Both motion sensor & light sensor work when indoor illumination < 13 lux. Sun Mode: Only motion sensor works (day or night). Trim rings available in various colours.

Code	Wattage	Lumens	Cut out Size (mm)	Material/Colour	Size (mm)	*Add Colour to Code
MD-RN220-18W-*	18W	1500lm	-	White	Ø220 x 18	WW / CW / DL
MD-SQ220-18W-*	18W	1500lm	-	White	220 x 220	WW / CW / DL

Round Trim Ring Colours – MD-RN220-TR-BK (Black), MD-RN220-TR-GD (Gold), MD-RN220-TR-S (Silver)  
Square Trim Ring Colours – MD-SQ220-TR-BK (Black), MD-SQ220-TR-GD (Gold), MD-SQ220-TR-S (Silver)

## RECESSED LED DOWNLIGHTS

### Non-Dimmable



BQ-RN

BQ-SQ

**Frameless Downlight** - Input Voltage: 100-240VAC | 110° Beam Angle | CRF >70

Code	Wattage	Lumens	Cut-out Size (mm)	Material/Colour	Size (mm)	*Add Colour to Code
BQ-RN-10-*	10W	1100lm	Ø98	White	Ø115 x 43	WW / CW / DL
BQ-RN-15-*	15W	1500lm	Ø115	White	Ø140 x 43	WW / CW / DL
BQ-RN-20-*	20W	2000lm	Ø140	White	Ø170 x 43	WW / CW / DL
BQ-SQ-10-*	10W	1100lm	95 x 95	White	115 x 115 x 45	WW / CW / DL
BQ-SQ-15-*	15W	1500lm	115 x 115	White	130 x 130 x 45	WW / CW / DL
BQ-SQ-20-*	20W	2000lm	140 x 140	White	160 x 160 x 45	WW / CW / DL

- WW - 2700K
- CW - 4200K
- DL - 6000K

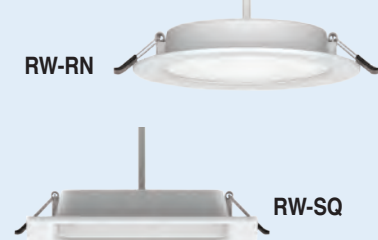

RW-RN

RW-SQ

**White Trim Downlight** - Input Voltage: 100-240VAC | Black Lit | 25,5mm depth | Beam Angle 140° | CRI > 70

Code	Wattage	Lumens	Cut out Size (mm)	Material/Colour	Size (mm)	*Add Colour to Code
RW-RN120-6W-*	6W	390lm	Ø95	White	Ø118	WW / CW / DL
RW-RN150-9W-*	9W	630lm	Ø110	White	Ø145	WW / CW / DL
RW-RN170-12W-*	12W	900lm	Ø140	White	Ø175	WW / CW / DL
RW-RN200-18W-*	18W	1530lm	Ø190	White	Ø222	WW / CW / DL
RW-SQ120-6W-*	6W	420lm	95 x 95	White	120 x 120	WW / CW / DL
RW-SQ150-9W-*	9W	675lm	110 x 110	White	145 x 145	WW / CW / DL
RW-SQ170-12W-*	12W	960lm	140 x 140	White	175 x 175	WW / CW / DL
RW-SQ220-18W-*	18W	1620lm	190 x 190	White	224 x 224	WW / CW / DL

- WW - 2700K
- CW - 4200K
- DL - 6000K

NEW



RN-RW04

SQ-RW04

**LED Panel with Integrated Driver** - Input Voltage: 175-265VAC | Aluminium & Plastic | Beam Angle 110°

RN-RW04-R6W-*	6W	300lm	Ø75	White	Ø90	WW / CW / DL
RN-RW04-R12W-*	12W	780lm	Ø100	White	Ø120	WW / CW / DL
RN-RW04-R16W-*	16W	1040lm	Ø150	White	Ø170	WW / CW / DL
RN-RW04-R24W-*	24W	1560lm	Ø200	White	Ø225	WW / CW / DL
SQ-RW04-R6W-*	6W	300lm	75 x 75	White	90 x 90	WW / CW / DL
SQ-RW04-R12W-*	12W	780lm	100 x 100	White	120 x 120	WW / CW / DL
SQ-RW04-R16W-*	16W	1040lm	150 x 150	White	170 x 170	WW / CW / DL
SQ-RW04-R24W-*	24W	1560lm	200 x 200	White	225 x 225	WW / CW / DL

# RECESSED LED DOWNLIGHTS

## Non-Dimmable

○ WW - 2700K  
○ CW - 4200K  
○ DL - 6000K



**Glass Trim Downlight - Input Voltage: 100-240VAC | Beam Angle 110°**

Code	Wattage	Lumens	Cut out Size (mm)	Material/ Colour	Size (mm)	*Add Colour to Code
DL-RN100-6W-*	6W	400lm	Ø75	White	Ø100 x 28	WW / CW / DL
DL-RN160-12W-*	12W	800lm	Ø120	White	Ø160 x 30	WW / CW / DL
DL-RN200-18W-*	18W	1200lm	Ø146	White	Ø173 x 34	WW / CW / DL
DL-SQ100-6W-*	6W	400lm	65 x 75	White	100 x 100 x 14	WW / CW / DL
DL-SQ160-12W-*	12W	800lm	115 x 120	White	160 x 160 x 14	WW / CW / DL
DL-SQ200-18W-*	18W	1200lm	155 x 160	White	220 x 220 x 14	WW / CW / DL

○ WW - 2700K  
○ CW - 4200K  
○ DL - 6000K



**Input Voltage: 85-265VAC | Aluminium | COB LED | Aluminium Reflector**

RAV160-DLC10W-*	10W	900lm	Ø140	White	Ø165 x 45	WW / CW / DL
RAV190-DLC20W-*	20W	1800lm	Ø170	White	Ø195 x 58	WW / CW / DL
RAV225-DLC30W-*	30W	2880lm	Ø205	White	Ø225 x 73	WW / CW / DL

○ WW - 2700K  
○ CW - 4200K



**Input Voltage: 175-265VAC | Plastic**

D6002-9W-*	9W	900lm	Ø93	White	Ø108 x 52	WW / CW
D9002-15W-*	15W	1500lm	Ø120	White	Ø142 x 65	WW / CW
D9002-20W-*	20W	2000lm	Ø142	White	Ø158 x 75	WW / CW
D9002-30W-*	30W	2700lm	Ø210	White	Ø230 x 85	WW / CW
D9002-40W-*	40W	3600lm	Ø210	White	Ø230 x 85	WW / CW
D9002-50W-*	50W	4500lm	Ø210	White	Ø230 x 85	WW / CW

○ WW - 2700K  
○ CW - 4200K  
○ DL - 6000K



**Input Voltage: 170-240VAC | Beam Angle: 180° | Plastic**

Code	Wattage	Lumens	Cut out Size (mm)	Material/ Colour	Size (mm)	*Add Colour to Code
PL-TD-5W-*	5W	350lm	Ø80-90	White	Ø100 x 60	CW / DL
PL-TD-12W-*	12W	840lm	Ø120-135	White	Ø146 x 80	CW / DL
PL-TD-20W-*	20W	1260lm	Ø155-170	White	Ø178 x 98	CW / DL
PL-TD-24W-*	24W	2000lm	Ø195	White	Ø252 x 90	WW / CW

○ WW - 2700K  
○ CW - 4200K  
○ DL - 6000K

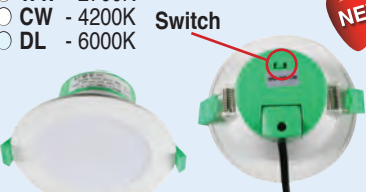

**Adjustable CCT LED Light - Input Voltage: 230VAC | Switch Adjustable CCT (2700K - 4000K - 5700K) | 100° Beam Angle | IP54**

DL54-CCT-10W	10W	900lm	Ø90	White	Ø115 x 60	WW / CW / DL
DL54-CCT-16W	16W	1600lm	Ø110	White	Ø140 x 65	WW / CW / DL
DL54-CCT-20W	20W	2000lm	Ø150	White	Ø190 x 70	WW / CW / DL

○ WW - 2700K  
○ CW - 4200K



**Input Voltage: 85-265VAC | Aluminium**

TD17-140-12W-*	12W	800lm	Ø125	Satin Silver	Ø140 x 95	WW / CW
TD17-165-15W-*	15W	1000lm	Ø145	Satin Silver	Ø190 x 72	WW / CW
TD17-195-18W-*	18W	1200lm	Ø175	Satin Silver	Ø230 x 70	WW / CW

○ WW - 2700K  
○ CW - 4200K  
○ DL - 6000K



**Input Voltage: 85-265VAC | Aluminium | Chrome Bezel**

LYD-BD6W-*	6W	550lm	Ø110	White	Ø130 x 66	WW / CW / DL
LYD-BD12W-*	12W	1050lm	Ø145	White	Ø162 x 70	WW / CW / DL
LYD-BD18W-*	18W	1600lm	Ø165	White	Ø190 x 70	WW / CW / DL
LYD-BD24W-*	24W	2400±5%lm	Ø210	White	Ø230 x 86	WW / CW / DL
LYD-FD5W1-*	5W	500±5%lm	Ø80	White	100 x 100 x 55	WW / CW / DL
LYD-FD9W1-*	9W	900±5%lm	Ø110	White	142 x 142 x 67	WW / CW / DL
LYD-FD12W1-*	12W	1200±5%lm	Ø145	White	172 x 172 x 70	WW / CW / DL
LYD-FD15W1-*	15W	1500±5%lm	Ø145	White	172 x 172 x 70	WW / CW / DL

COMMERCIAL

LIGHTING



## RECESSED LED DOWNLIGHTS

### Non-Dimmable

- WW - 2700K
- CW - 4200K



LBS-1201\*

LBS-1202\*

Input Voltage: 100-240VAC | Aluminium

Code	Wattage	Lumens	Cut out Size (mm)	Material/ Colour	Size (mm)	*Add Colour to Code
LBS-1201-*	10W	475lm	Ø78	White	Ø85 x 82	WW / CW
LBS-1202-*	10W	475lm	Ø78	White	Ø85 x 82	WW / CW

- WW - 2700K
- CW - 4200K



Input Voltage: 85-265VAC | Aluminium

Code	Wattage	Lumens	Cut out Size (mm)	Material/ Colour	Size (mm)	*Add Colour to Code
COB-S190/10W-*	10W	900lm	90 x 90	White	110 x 110 x 52	WW / CW
COB-S190/20W-*	20W	2000lm	130 x 130	White	147 x 147 x 52	WW / CW
COB-S190/30W-*	30W	3000lm	160 x 160	White	180 x 180 x 52	WW / CW

- CW - 4200K
- DL - 6000K



Input Voltage: 85-265VAC | Recessed LED with Reflector

Code	Wattage	Lumens	Cut out Size (mm)	Material/ Colour	Size (mm)	*Add Colour to Code
NED-D09W04-*	9W	680lm	Ø70	White	Ø85 x 85	CW / DL
NED-D15W04-*	15W	1100lm	Ø94	White	Ø118 x 97	CW / DL
NED-D20W04-*	20W	1500lm	Ø118	White	Ø158 x 97	CW / DL
NED-D30W04-*	30W	2150lm	Ø139	White	Ø160 x 108	CW / DL
NED-D40W04-*	40W	2800lm	Ø210	White	Ø226 x 108	CW / DL
NED-D50W04-*	50W	3500lm	Ø265	White	Ø282 x 130	CW / DL
NED-D60W04-*	60W	7200lm	Ø200	White	Ø229 x 85	CW / DL
NED-D70W04-*	70W	8400lm	Ø200	White	Ø230 x 112	CW / DL
NED-D80W04-*	80W	9000lm	Ø200	White	Ø235 x 95	CW / DL

- WW - 2700K
- CW - 4200K



Input Voltage: 230VAC | IP20 | Beam Angle 38° | Optional Ring for Aesthetics

DL-B0105-*	5W	375lm	Ø68	*BK, WH, SN	Ø85 x 50mm	WW / CW
DL-B0107-*	7W	525lm	Ø68	*BK, WH, SN	Ø85 x 50mm	WW / CW

\* Add Trim Colours to Code: BK (Black), WH (White), SN (Satin Nickel)

#### Accessories

Code	Description	*Add Colour to code
DL-B010-TRIM-*	Trim Ring for surface look	BK (Black), WH (White), SN (Satin Nickel)

- CW - 4200K



Input Voltage: 230VAC | c/w Driver | Beam Angle 30° | Glass | IP44

RWCL-3W	3W	270lm	Ø56	White	Ø70 x 66	CW
RWCL-7W	7W	630lm	Ø76	White	Ø90 x 72	CW

- WW - 2700K
- CW - 4200K



RW-RSL

RW-SSL

Input Voltage: 230VAC | ABS + PC | IP44

RW-RSL82-6W-*	6W	400lm	Ø65-70	White	Ø82 x 40	WW / CW
RW-SSL82-6W-*	6W	400lm	65-70	White	82 x 82 x 40	WW / CW

# RECESSED LED DOWNLIGHTS

## Colours

○ CW - 4200K

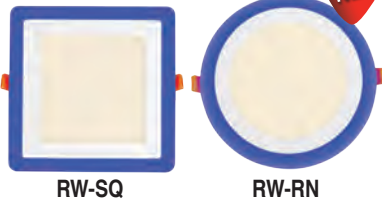

Input Voltage: 100-240VAC | Blue LED Trim | Dual Colour | Beam Angle 110°

RW-RN145-CW-BL	6 + 3W	195 + 130lm	Ø105	White	Ø145	CW
RW-RN195-CW-BL	12 + 4W	260 + 260lm	Ø155	White	Ø195	CW
RW-RN245-CW-BL	18 + 6W	390 + 390lm	Ø210	White	Ø245	CW
RW-SQ145-CW-BL	6 + 3W	195 + 130lm	105 x 105	White	145 x 145	CW
RW-SQ195-CW-BL	12 + 4W	260 + 260lm	155 x 155	White	195 x 195	CW
RW-SQ245-CW-BL	18 + 6W	390 + 390lm	210 x 210	White	245 x 245	CW

○ WW - 2700K  
○ CW - 4200K



Input Voltage: 230VAC | Beam Angle: 20°

HI-001-1W-*	3W	70lm	Ø56	Silver	Ø69 x 69	WW / CW / OR / GN / BL / Y
HI-001-3W-*	7W	140lm	Ø76	Silver	Ø69 x 79	

Input Voltage: 230VAC | Beam Angle: 30°

HI-004-3W-*	3W	210lm	Ø66	Silver	Ø75 x 109	WW / CW / OR / GN / BL / Y
HI-004-9W-*	9W	420lm	Ø66	Silver	Ø75 x 109	
HI-007-3W-*	3W	210lm	Ø78	Silver	Ø92 x 86	
HI-007-9W-*	9W	420lm	Ø78	Silver	Ø92 x 121	
HI-010-1W-*	1W	70lm	Ø42	Silver	Ø50 x 40	
HI-010-3W-*	3W	140lm	Ø42	Silver	Ø50 x 50	
HI-012-1W-*	1W	70lm	Ø42	Silver	Ø55 x 37	
HI-012-3W-*	3W	140lm	Ø42	Silver	Ø55 x 47	
LED-3134-*	3W	220lm	Ø65	White	Ø79 x 27	WW / CW

○ WW - 2700K  
○ CW - 4200K



Input Voltage: 230VAC | Beam Angle: 120°

LS0127H-*	3W	270lm	Ø75	Silver	Ø80 x 67	WW / CW / OR / GN / BL / Y
-----------	----	-------	-----	--------	----------	----------------------------

○ WW - 2700K  
○ CW - 4200K

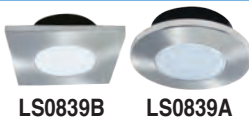

Input Voltage: 100-240VAC | c/w LED Driver | Stainless Steel

LS0839A-*	1.5W	120lm	Ø60	Silver	Ø69 x 23	WW / CW
LS0839B-*	1.5W	120lm	60 x 60	Silver	67 x 67 x 23	WW / CW

NEW

## SMART BLUETOOTH GLASS TRIM DOWNLIGHT

Smart LED Downlight - Input Voltage: 230VAC | 110° Beam Angle



Code	Wattage	Lumens	Cut out Size (mm)	Material/ Colour	Size (mm)
BT-DL-RN100-6W	6W	300lm	Ø75	White	Ø100 x 40
BT-DL-RN160-12W	12W	840lm	Ø125	White	Ø160 x 40
BT-DL-RN200-18W	18W	1350lm	Ø165	White	Ø200 x 40

### Features

- Supports 16+ colour changes
- Synchronises lights with music rhythm

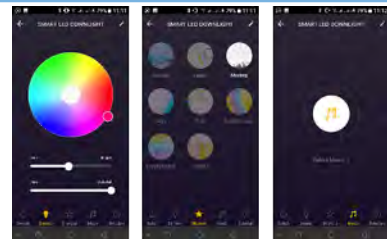
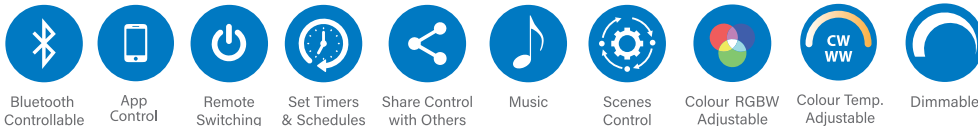

Pick Colour Set Scene Select Music

NEW

## SMART BLUETOOTH FRAMELESS PANEL LIGHT

Input Voltage: 230VAC | 180° Beam Angle | CRI >80 | PC + Aluminium | Seamless Design



Code	Wattage	Lumens	Cut out Size (mm)	Material/ Colour	Size (mm)
MB004-9W-RGBW	9W	900lm	Ø71	White	Ø90 x 27
MB004-18W-RGBW	18W	1800lm	Ø106	White	Ø120 x 27
MB004-36W-RGBW	36W	3600lm	Ø206	White	Ø225 x 27

Order remote Separately for RF Control (MB004-REMOTE)

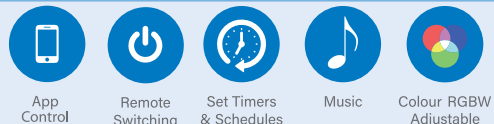

## RECESSED LED DOWNLIGHTS

Non-Dimmable

Input Voltage: 230VAC | Beam Angle: 120°



Code	Wattage	Lumens	Cut out Size (mm)	Material/ Colour	Size (mm)	*Add Colour to Code
LCM4105-RGB	15W	270lm	Ø75	Silver	Ø80 x 67	●●●RGB

- WW - 2700K
- CW - 4200K



Input Voltage: 100-240VAC | c/w LED Driver | Plastic | Ideal for Coastal Areas

Code	Wattage	Lumens	Cut out Size (mm)	Material/ Colour	Size (mm)	*Add Colour to Code
TD60-48D-*	2.5W	240lm	Ø70	White	Ø80 x 37	WW / CW

## RECESSED LED DOWNLIGHTS IP54-65

Non-Dimmable

- WW - 2700K
- CW - 4200K



Code	Wattage	Lumens	Cut out Size (mm)	Material/ Colour	Size (mm)	*Add Colour to Code
CT-3312-*	1W	90lm	Ø50	Silver	Ø77 x 24	WW / CW

Input Voltage: 12V | c/w LED Driver | Stainless Steel | IP54

CT-3312-*	1W	90lm	Ø50	Silver	Ø77 x 24	WW / CW
-----------	----	------	-----	--------	----------	---------

Input Voltage: 100 - 240V | c/w LED Driver | Stainless Steel & Glass | IP54

CT-3620-*	1W	130lm	Ø75	White	Ø105 x 40	WW / CW
-----------	----	-------	-----	-------	-----------	---------

Input Voltage: 100 - 240V | c/w LED Driver | IP65

LED-3322A-*	3W	130lm	Ø65	Silver	Ø100 x 90	WW / CW
LED-3324A-*	3W	130lm	Ø65	Silver	90 x 90 x 90	WW / CW

NEW

## LINEAR RECESSED LED DOWNLIGHTS

Non-Dimmable

- WW - 2700K
- CW - 4200K

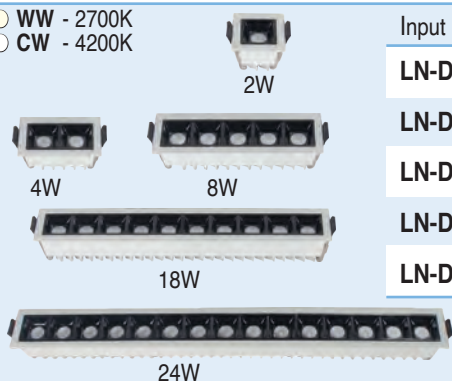

Input Voltage: 85 - 265VAC

LN-D001A-1-*	2W	160lm	37 x 37	Black	45 x 45 x 50	WW / CW
LN-D001A-2-*	4W	320lm	68 x 37	Black	75 x 45 x 50	WW / CW
LN-D001A-5-*	8W	640lm	140 x 37	Black	145 x 45 x 50	WW / CW
LN-D001A-10-*	18W	1440lm	273 x 37	Black	280 x 45 x 50	WW / CW
LN-D001A-15-*	24W	1420lm	405 x 37	Black	411 x 45 x 50	WW / CW

NEW

## ADJUSTABLE RECESSED MOUNT LED DOWNLIGHTS

Non-Dimmable

- WW - 2700K
- CW - 4200K



Input Voltage: 85-265VAC

Code	Wattage	Lumens	Cut out Size (mm)	Material/ Colour	Size (mm)	*Add Colour to Code
RW-IN25-*	25W	2000lm	220 x 130	White	230 x 146 x 86	WW / CW
RW-IN40-*	40W	3200lm	220 x 130	White	230 x 146 x 86	WW / CW

# ADJUSTABLE RECESSED LED DOWNLIGHTS

## Non-Dimmable

- WW - 2700K
- CW - 4200K



Input Voltage: 230VAC | Beam Angle: 60° | c/w Driver

Code	Wattage	Lumens	Cut out Size (mm)	Material/ Colour	Size (mm)	*Add Colour to Code
NED-D3W05B-*	3W	250lm	Ø73	White	Ø90 x 60	WW / CW
NED-D7W05B-*	7W	550lm	Ø98	White	Ø105 x 85	WW / CW
NED-D12W05B-*	12W	900lm	Ø113	White	Ø138 x 90	WW / CW

- WW - 2700K
- CW - 4200K



Input Voltage: 100-240VAC | Tilttable

Code	Wattage	Lumens	Cut out Size (mm)	Material/ Colour	Size (mm)	*Add Colour to Code
CHR-090-9W-*	9W	600lm	Ø75	White	Ø95 x 66	WW / CW
CHR-090-12W-*	12W	800lm	Ø90	White	Ø110 x 72	WW / CW

- WW - 2700K
- CW - 4200K

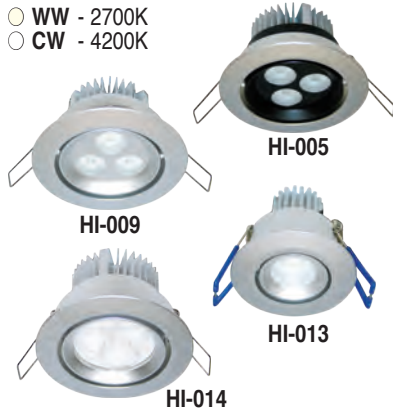

Input Voltage: 230VAC | c/w LED Driver | Beam Angle: 30°

Code	Wattage	Lumens	Cut out Size (mm)	Material/ Colour	Size (mm)	*Add Colour to Code
HI-005-3W-*	3W	210lm	Ø78	Black	Ø90 x 75	WW / CW / ●R / ●GN / ●BL / ●Y
HI-005-9W-*	9W	420lm	Ø78	Black	Ø90 x 119	
HI-009-3W-*	3W	210lm	Ø78	Silver	Ø90 x 75	
HI-009-9W-*	9W	420lm	Ø78	Silver	Ø90 x 119	
HI-013-1W-*	1W	70lm	Ø42	Silver	Ø55 x 37	
HI-013-3W-*	3W	140lm	Ø42	Silver	Ø55 x 47	
HI-014-3W-*	3W	210lm	Ø78	Silver	Ø92 x 86	
HI-014-9W-*	9W	420lm	Ø78	Silver	Ø92 x 121	

- WW - 2700K
- CW - 4200K



Input Voltage: 230VAC | c/w LED Driver | Beam Angle: 120°

Code	Wattage	Lumens	Cut out Size (mm)	Material/ Colour	Size (mm)	*Add Colour to Code
LS0127B-*	3W	270lm	Ø75	Silver	Ø90 x 46	WW / CW / ●R / ●GN / ●BL / ●Y

- WW - 2700K
- CW - 4200K



Input Voltage: 100-240VAC | c/w LED Driver | Plastic | Ideal for Coastal Areas

Code	Wattage	Lumens	Cut out Size (mm)	Material/ Colour	Size (mm)	*Add Colour to Code
TD70-60D-*	3W	285lm	Ø80	White	Ø90 x 49	WW / CW

- WW - 2700K
- CW - 4200K



Input Voltage: 100-240VAC | PBT Thermal Plastic | Tilttable | Beam Angle 38° | RA80

Code	Wattage	Lumens	Cut out Size (mm)	Material/ Colour	Size (mm)	*Add Colour to Code
RN-AP3-3W-*	3W	240lm	Ø60	White	Ø75 x 45	WW / CW
RN-AP3-5W-*	5W	400lm	Ø75	White	Ø90 x 45	WW / CW
RN-AP3-7W-*	7W	560lm	Ø75	White	Ø90 x 45	WW / CW
RN-AP3-10W-*	10W	800lm	Ø95	White	Ø120 x 55	WW / CW
SQ-AP3-3W-*	3W	240lm	60 x 60	White	75 x 75 x 45	WW / CW
SQ-AP3-5W-*	5W	400lm	75 x 75	White	90 x 90 x 45	WW / CW
SQ-AP3-7W-*	7W	560lm	75 x 75	White	90 x 90 x 45	WW / CW
SQ-AP3-10W-*	10W	800lm	95 x 95	White	120 x 120 x 55	WW / CW

COMMERCIAL

LIGHTING

# ADJUSTABLE RECESSED LED DOWNLIGHTS

## Non-Dimmable

- WW - 2700K
- CW - 4200K



Input Voltage: 85-265VAC | Aluminium

Code	Wattage	Lumens	Cut out Size (mm)	Material/ Colour	Size (mm)	*Add Colour to Code
VKC-50-*	3W	244lm	1 x Ø80	Silver	90 x 90 x 49	WW / CW
VKC-51-*	6W	450lm	2 x Ø80	Silver	175 x 90 x 50	WW / CW
VKC-52-*	9W	720lm	3 x Ø80	Silver	179 x 62 x 25	WW / CW

- WW - 2700K
- CW - 4200K



Input Voltage: 85-265VAC | Aluminium

Code	Wattage	Lumens	Cut out Size (mm)	Material/ Colour	Size (mm)	*Add Colour to Code
NED-D20-*	1 x 20W	1550lm	Ø119	Silver	135 x 135 x 93	WW / CW
NED-D40-*	2 x 20W	3000lm	238 x 119	Silver	260 x 135 x 93	WW / CW
NED-D60-*	3 x 20W	4500lm	360 x 119	Silver	382 x 135 x 93	WW / CW

- WW - 2700K
- CW - 4200K

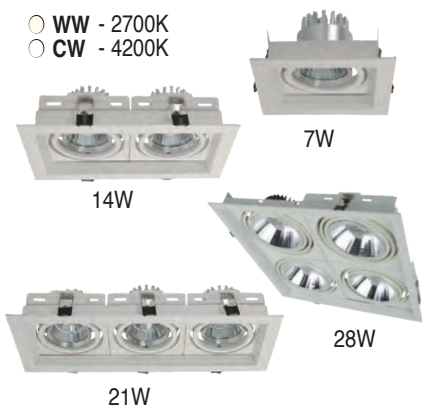

Input Voltage: 90-250VAC | Aluminium cover & Steel Housing

Code	Wattage	Lumens	Cut out Size (mm)	Material/ Colour	Size (mm)	*Add Colour to Code
GDL6H-1R-*	1 x 7W	580lm	110 x 110	Silver	125 x 125 x 90	WW / CW / DL
GDL12H-2R-*	2 x 7W	1160lm	210 x 110	Silver	225 x 125 x 90	WW / CW / DL
GDL18H-3R-*	3 x 7W	1740lm	305 x 110	Silver	320 x 125 x 90	WW / CW / DL
GDL24HS-*	4 x 7W	2320lm	215 x 215	Silver	230 x 230 x 90	WW / CW / DL

- WW - 2700K
- CW - 4200K



Input Voltage: 85-265VAC | 2 Way Adjustable

Code	Wattage	Lumens	Cut out Size (mm)	Material/ Colour	Size (mm)	*Add Colour to Code
COB-S192/10W-*	1 x 10W	900lm	93 x 97	White	120 x 120 x 52	WW / CW
COB-S192/20W-*	2 x 10W	1800lm	188 x 97	White	215 x 120 x 52	WW / CW
COB-S192/30W-*	3 x 10W	2700lm	285 x 97	White	310 x 120 x 52	WW / CW

- WW - 2700K
- CW - 4200K



Adjustable Commercial Spotlight Fittings - Input Voltage: 230VAC | Beam Angle: 24°

Code	Wattage	Lumens	Cut out Size (mm)	Material/ Colour	Size (mm)	*Add Colour to Code
HQ-43013-*	12W	1000lm	Ø155	White	Ø162 x 120	WW / CW
TLL27-15W-*	15W	1300lm	Ø175	White	Ø190 x 180	WW / CW
RS-Q401-20W-*	20W	1400lm	Ø175	White	Ø188 x 150	WW / CW
RS-Q401-30W-*	30W	2100lm	Ø175	White	Ø188 x 150	WW / CW
8822-301-*	30W	1600lm	Ø160	White	Ø164 x 120	WW / CW
8819-302-*	30W	1600lm	160 x 160	White	168 x 168 x 180	WW / CW

## DOWNLIGHTS



**Aluminium Recessed Spot Lights - G4 Lamp 20W** (see page 12 for LED)

Code	*Colour	Hole Size	Bezel Size
ELC-127-*	*SN, CH, WH	25mm	30mm
ELC-258-*	*SN, CH, WH	26mm	50mm

**Fixed - (Zinc Alloy)**

Code	*Colour	Hole Size	Bezel Size
SL-200-*	*WH, CH, SN, PB	96mm	67mm

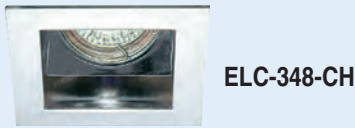
\*Add colour to code. Lamps excluded.

**Steel Recessed Spot Lights - 50W**

Code	*Colour	Hole Size	Bezel Size
ELC-348M-*	*SN, CH, WH	75x75mm	90x90mm

\*Add colour to code. Lamp holder excluded.

**Glass Recessed Spot Lights**

Code	Colour	Lamp Type	Hole Size	Bezel Size
ELC-004S	Chrome/ Clear Crystal	<b>G4-12</b>	55mm	80mm
ELC-004C	Chrome/ Clear Crystal	<b>JC-12</b>	58mm	110mm
ELC-001S	Chrome/ Clear Crystal	<b>G4-12</b>	55mm	80mm
DT-30	Chrome/ Clear Crystal	<b>G4-12</b>	60mm	70mm

For LED lamps see page 12

**Luxury Downlighters - Lamp holder excluded.**

Code	*Colour	Hole Size	Bezel Size
D-224*	*WH, PB, CH	85mm	100mm
D-320*	*WH, PB, CH, SN	105mm	120mm

\*Add colour to code

Code	Colour	Hole Size	Bezel Size
SL-009SS/G	Pearl/Gold	89mm	97mm
SL-034A	Gold	76mm	95mm
SD105-BP	Pearl/Gold	85mm	95mm

## SPECIAL DOWNLIGHTS

Lamp Holder:	G4	MR16	MR16	Lamp G4 12V	
GU5.3 or GU10 see page 148					
<b>Code Clear</b>	<b>D-9852B-E51</b>	<b>Code</b>	<b>DG-110CR</b>	<b>DG-70/2C</b>	<b>SL-094SN</b>
<b>Code Blue</b>	<b>D-9852B-E53</b>	Description	CH/ Clear	CH/ Clear	Stainless Steel complete with on/off switch Lamp excluded <b>JC-12-20</b>
<b>Code Rose</b>	<b>D-9852B-E52</b>	Hole size Ø	58mm	48mm	
Hole size Ø	-	Bezel Ø	110mm	70mm	
Bezel Ø	-				
Lamp Holder:	Use LED MR16 Lamp for colour effect			MR16	MR16
GU5.3 or GU10 see page 148					
<b>Code</b>	<b>SL-222G</b>	<b>SL-005G</b>	<b>SL-048G</b>	<b>ELC-287-T</b>	<b>ELC-2874-C4</b>
Colour	Satin/Clear	Satin/Clear	SN/G+Clear	CH/Clear Crystal	SN/G+Clear
Hole Size Ø	67mm	67mm	65mm	58mm	68mm
Bezel Ø	82mm	81mm	80mm	121mm	83mm

\*For MR16, order CLH202. For GU10, order LH2-ST.

# DOWNLIGHTS



		<b>Fixed</b> (Pressed Metal) <span style="float: right;"><i>Lamp holder excluded.*</i></span>	
Code	*Colour	Hole Size	Bezel Size
SL-076*	*WH, BK, PB, CH, RB, GB, SN, GM	60mm	80mm
<small>*Add colour to code</small>			

		<b>Fixed</b> (Zinc Alloy die cast) <span style="float: right;"><i>Lamp holder excluded.*</i></span>	
Code	*Colour	Hole Size	Bezel Size
SL-006*	*WH, PB, GM, SN	62mm	80mm
<small>*Add colour to code</small>			

			<b>2 Way Adjustable</b> (Zinc Alloy die cast) <span style="float: right;"><i>Lamp holder excluded.*</i></span>	
Code	*Colour	Hole Size	Bezel Size	
SL-250*	*WH, BK, PB, CH, RB, GB, SN, GM, SN/G†	73mm	83mm	
<small>*Add colour to code. †Satin Nickel with gold trim</small>				

		<b>Fixed</b> (Zinc Alloy die cast) GU10 Lamp no retaining clip required <span style="float: right;"><i>Lamp holder excluded.*</i></span>	
Code	*Colour	Hole Size	Bezel Size
SL-025*	*WH, SN, CH, PB	73mm	82mm
<small>*Add colour to code</small>			

	<b>2 Way Adjustable</b> (Zinc Alloy die cast)		
Code	*Colour	Hole Size	Bezel Size
SL-028*	*WH, SN, CH, PB	80mm	96mm
<small>*Add colour to code</small>			

		<b>Eyeball Downlighters</b> (Pressed Metal) <span style="float: right;"><i>Lamp holder excluded.*</i></span>	
Code	*Colour	Hole Size	Bezel Size
SL-203*	*WH, PB, CH, GM, SN	100mm	110mm
SL-009*	*CH/G†, SN/N, SS/G	89mm	101mm
<small>*Add colour to code. †Chrome with gold trim</small>			

		<b>Fixed</b> (pressed metal) - For MR11 <span style="float: right;"><i>Lamp holder excluded.*</i></span>	
Code	*Colour	Hole Size	Bezel Size
SL-078*	*SN, PB, WH 2 way tilt	55mm	68mm
SL-080*	*SN, PB, WH fixed	55mm	68mm
<small>*Add colour to code</small>			

*\*For MR16, order CLH202. For GU10, order LH2-ST.*

		<b>Zink Alloy Recessed Spot Lights</b> <span style="float: right;"><i>Lamp holder excluded.*</i></span>	
Code	*Colour	Hole Size	Bezel Size
ELC-144*	*SN, CH, WH, PB	62mm	75 x 75mm
ELC-429*	*SN, CH, WH, PB	75mm	82 x 82mm

	<b>Aluminium Recessed Spot Lights</b> <span style="float: right;"><i>Lamp holder excluded.*</i></span>		
Code	*Colour	Hole Size	Bezel Size
SL-204*	*SN, CH, WH	2 x 65mm	220 x 100mm
<small>*Add colour to code</small>			

		<b>Aluminium Recessed Spot Lights - 50W</b> <span style="float: right;"><i>Lamp holder excluded.*</i></span>	
Code	*Colour	Hole Size	Bezel Size
ELC-618B*	*WH	95mm	105mm
ELC-618C*	*WH	95mm	105mm
<small>*Add colour to code</small>			

		<b>Aluminium Recessed Spot Lights - 50W</b> <span style="float: right;"><i>Lamp holder excluded.*</i></span>	
Code	*Colour	Hole Size	Bezel Size
ELC-3390*	*SN, CH, WH	95mm	108mm
ELC-265*	*SN, CH, WH	108mm	127mm
<small>*Add colour to code</small>			

*\*For MR16, order CLH202. For GU10, order LH2-ST.*

2 Year warranty on all LED products, unless otherwise specified. Warranty void if adequate surge protection is not installed on LED products. See page 147

**NEW**

## PLASTIC DOWNLIGHTS

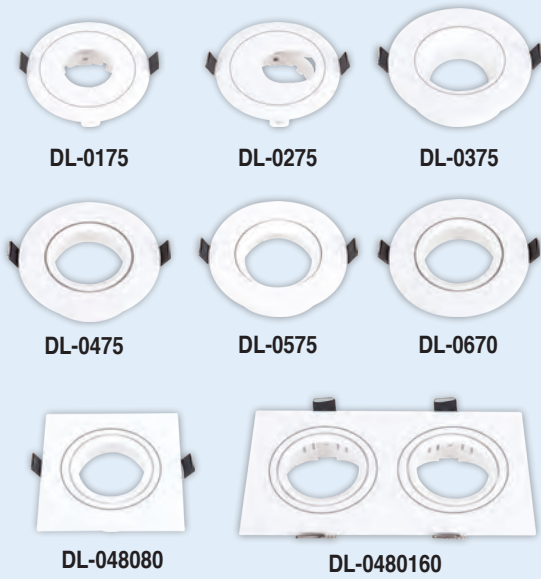
 Suitable for GU10 or MR16 Lamps (Lamp holder to be ordered separately, see page 148).  
 Ideal for Coastal Areas

Code	Colour	Cut-Out (mm)	Bezel Size (mm)
DL-0175	White	Ø75	Ø88
DL-0275	White	Ø75	Ø88
DL-0375	White	Ø75	Ø90
DL-0475	White	Ø75	Ø90
DL-0575	White	Ø75	Ø90
DL-0670	White	Ø75	Ø90
DL-048080	White	75 x 75	93 x 93
DL-0480160	White	80 x 160	173 x 93
DL-0480240	White	80 x 240	252 x 93
DL-0785A	White	85 x 85	93 x 93
DL-0785B	White	85 x 85	93 x 93
DL-0885A	White	Ø85	Ø93
DL-0885B	White	Ø85	Ø93
DL-09100A	White	Surface Mount	96 x 96 x 100



## DOWNLIGHTS IP54



Code	CT-3309	CT-3621
Base	MR16	MR16
Power	Max. 50W/ 11W CFL	Max. 35W/ 11W CFL
Size (mm)	Ø86 x 35	100 x 100 x 85
Cutout (mm)	60	75
Material	Satin Nickel	S/Steel with Glass Trim

## LED DOWNLIGHTS IP20

**COMMERCIAL**

 Supply Voltage:  
 230V/50Hz

Code	LED-29G-A*	LED-29G-B*	LED-29G-C*	LED-29G-D*	LED-29G-F*
Hole Size (mm)	78.5 Ø	78.5 Ø	78.5 Ø	78.5 Ø	78.5 Ø
Bezel Size (mm)	88.5 Ø	105.5 Ø	90.5 Ø	95 Ø	83.5 Ø
LEDs	29	29	29	29	29

\*Add LED colour to code: ○ WH (White), ● BL (Blue), ● Y (Yellow), ● GN (Green), ● R (Red)

**LIGHTING**

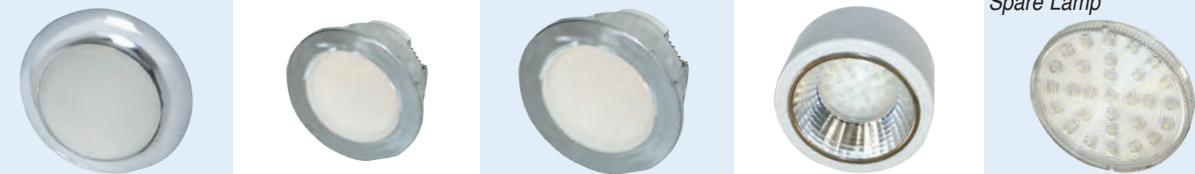
 Supply Voltage:  
 230V/50Hz

Code	LED-30T-2*	LED-25P-1*	LED-30P-1*	LED-52A-29G*	LD-29G*
Hole Size (mm)	74 Ø	60 Ø	74 Ø	-	-
Bezel Size (mm)	95 Ø	74 Ø	90 Ø	64.5H x 132 Ø	75 Ø
LEDs	61	19	61	29	29

\*Add LED colour to code: ○ WH (White), ● BL (Blue), ● Y (Yellow), ● GN (Green), ● R (Red)



## CFL DOWNLIGHTS

### Downlights for GX53 lamps

Material:  
Plastic  
Base: GX53  
(Lamps  
Excluded)



Code	L0501CB*	L0503RC*	L0504RC*	L0505CL
Size (mm)	Ø83 x 18H	Ø135 x 60H	Ø100 x 15H	Ø132 x 217H
Type	Surface mount(1)	Recessed c/w reflector(1)	Recessed fixed(1)	Ceiling mount

\*Add colour of bezel to code: ○ W (white), ● S (Silver), ● G (Gold) eg. L0504RC-W  
(1)Fly lead and terminal block supplied

### Downlights for GX53 lamps

Material:  
Plastic  
Base: GX53  
(Lamps  
Excluded)



With on/off switch

### Downlights For PAR lamps E27

Material:  
Plastic  
(Lamps  
Excluded)

For PAR30  
& 38



### Aluminium IP20



Code	DGX5360*	EL-306-53RS*	Code	L0601CL	NB1048-PL
Size (mm)	Ø135 x 60H	Ø90 x 33H	Size (mm)	Ø137 x 272H	230 x 144 x 145
Type	Surface mount	Surface mount	Base	E27	G24d
	*Add bezel colour: ○ W (White), ● BK (Black)	*Add bezel colour: ○ W (White), ● S (Silver)	Power	20W CFL	18W CFL
			Type	Fixed	Adjustable
				White only	Cutout size: 126 x 216mm

Supply  
Voltage  
230VAC

### GX70 Lamp



### GX70 Downlight Fittings - Satin Nickel I c/w Lamps



Code	ESGX70-131*	CT-3712	CT-3733	CT-3734
Base	GX70	GX70	GX70	GX70
Power	18W	Max. 18W	Max. 18W	Max. 18W
Size (mm)	Ø110 x 45	Ø148 x 52	Ø170 x 68	Ø120 x 40
Cutout (mm)	-	130	150	35

\*Add colour to code: ○ WW (Warm White) 2700K, ○ CW (Cool White), 4200K

## PLASTIC DOWNLIGHTS

### Downlights for GU10 lamps

Material:  
Flame  
Retardant  
ABS  
Base: GU10  
(Lamps  
Excluded)



Code	L0301RC*	L0302RC*	L0303RC*	DU50128*
Size (mm)	Ø80 x 91H	Ø85 x 67H	Ø102 x 128H	Ø128 x 70H
Type	Fixed	Adjustable	Fixed c/w reflector	Adjustable c/w reflector

\*Add colour of bezel to code: ○ W (white), ● S (Silver), ● G (Gold) eg. L0301RC-W. For CFL or LED Lamps only.

## RECESSED AR111 DOWNLIGHTS



**Low Voltage Box Lighting**

Code	Watts	Cutout Size L x W x H (mm)
HL011-1 WH	1 x 50W	200 x 200 x 140
NB1034-E	3 x 50W	450 x 167 x 135
NB1034-G	4 x 50W	320 x 320 x 135

- All supplied without 230/12V transformer. • Lampholder AR111.
- Colour of frame White.
- Excluding lamps see pages 23 | For LED Lamps see page 14

## SURFACE MOUNT DOWNLIGHTS

Supplied complete with iron ballast. For PLC lamps only

<b>Code</b>	<b>WL-6036</b>	<b>WL-8006</b>	<b>WL-6046</b>
<b>Size (mm)</b>	197Ø x 125H	232Ø x 220H	197Ø x 125H
<b>Lamp Type</b>	PLC-13/ 2 x 13W	E27	PLC-13/ 2 x 13W

## METAL HALIDE DOWNLIGHTS FLUSH MOUNTING



Code	Colour	Lamp	Cut-out	Bezel
NB1040	White	Metal Halide 230V 150W max	215mm Ø	230mm Ø
T07A-SN	Satin Nickel	Metal Halide 230V 150W max	215mm Ø	230mm Ø
NB1046	White	Metal Halide 230V 150W max	220mm Ø	235mm Ø

Control gear and lamp not included. Control gear **NB150GB**. Lamps **MD-150** (see page 25-26)

<b>NB1048-W</b>	White	Metal Halide 230V 150W max	200 x 215mm	288 x 140mm
-----------------	-------	----------------------------	-------------	-------------

Control gear and lamp not included. Control gear **NB150GB**. Lamps **MD-150** (see page 25-26)

## METAL HALIDE DISPLAY LIGHTING



**150W Metal Halide - c/w control gear**

Code	Colour	Description
NB1044-BK	Black	Metal Halide 230V 150W max
NB1044-WH	White	Metal Halide 230V 150W max
EL200733	White	Metal Halide 230V 150W max

Lamp excluded, see page 25-26

## LED SUSPENDED DOWNLIGHTS



**Suspended Multiple Light - Supply Voltage 230VAC | c/w 12W LED Lamps**

Code	Watts	Lamp Type	Lamp Volts	Dimensions (mm)
NDL512E	10W	AR111	12VAC	485 x 190 x 30
NDL514E	10W	AR111	12VAC	815 x 190 x 30
NDL516E	10W	AR111	12VAC	1240 x 190 x 30
NDL514LM	6W	MR16	12VAC	640 x 130 x 30
NDL514RM	6W	MR16	12VAC	340 x 240 x 30
NDL514LG	6W	GU10	230VAC	460 x 130 x 30
NDL514RG	6W	GU10	230VAC	240 x 240 x 30





- Material: Aluminium
- Adjustable length suspension wires included (max length 1.2m)
- Fittings for low voltage AR111 and MR16 lamps electronic transformer included. For LED Lamps see page 14







COMMERCIAL

LIGHTING

## HORIZONTAL CFL DOWNLIGHTS

230VAC No Glass Cover				
<b>Code White</b>	<b>MD-76109H</b> (1 x 9W) <b>MD-76209H</b> (2 x 9W)	<b>SD-76113WH*</b>	<b>F609WH-18*-ELC</b>	<b>F806WH-26-ELC</b>
<b>Code Satin Nickel</b>	-	-	<b>F609SN-18*</b>	<b>F806SN-26*</b>
Size (mm)	190Ø x 100H	190Ø x 100H	190Ø x 100H	240Ø x 130H
Cut-out Size (mm)	175Ø	175Ø	170Ø	215Ø
Lamp Type	<b>PL-9</b>	<b>PLC-13/1 x 13W</b>	<b>PLC-18/2 x 18W</b>	<b>PLCE-26/2 x 26W</b>

\*Add **EMG** to code for Emergency (1H)

230VAC c/w Frosted Glass Cover				
<b>Code White</b>	<b>MD-76209HF*</b>	<b>MD-76213HF**</b>	<b>FG602WH-18*</b>	<b>FG806WH-26-ELC</b>
<b>Code Satin Nickel</b>	-	-	<b>FG602SN-18*</b>	<b>FG806SN-26-ELC</b>
Size (mm)	190Ø x 110H	190Ø x 110H	190Ø x 110H	240Ø x 130H
Cut-out Size (mm)	175Ø	165Ø	165Ø	215 Ø
Lamp Type	<b>PL-9/2 x 9W</b>	<b>PLC-13/2 x 13W</b>	<b>PLC-18/2 x 18W</b>	<b>PLCE-26/2 x 26W</b>

\*For emergency 1H add 'EMG' to code

\*For electronic ballast add '-ELC' to code. For ELC use **PLCE** lamps \*Add **EMG** to code for Emergency (1H)  
Lamps to be ordered separately see page 18

## CFL DOWNLIGHTS

### Vertical C.F.L. Downlights - 230V c/w Magnetic Ballast

Lamps to be ordered separately. See page 18.



<b>Code</b>	<b>SD-74113VB3</b>	<b>SD-75113V</b>
Size (mm)	150Ø x 186H	180Ø x 190H
Cut-out Size (mm)	125Ø	155Ø
Lamp Type	<b>PLC-13/1 x 13W</b>	<b>PLC-13/1 x 13W</b>

### Downlights - Ballast to be ordered separately | 270Ø x 69Hmm



DL-2050-WH

DL-2050-SN

<b>Colour</b>	White	<b>Code</b>	<b>DL-2050-WH-26</b>
	Satin-Nickel		<b>DL-2050-SN-26</b>
	Lamp type <b>PLC-26</b> (2 x 26W)		

### Horizontal C.F.L. Downlights - (Excludes ballast. To be ordered separately)



ELC-8026\*

ELC-8024\*

Code	Colour	Cutout Size Ø	Size Ø x H	Watts/Lamp Type
<b>ELC-8026*</b>	* WH (White)	205mm	222 x 185mm	26W / 2 x PLC-26
	* SN (Satin Nickel)			
<b>ELC-8024*</b>	* WH (White)	205mm	222 x 185mm	26W / 2 x PLC-26
	* SN (Satin Nickel)			

Lamps to be ordered separately - see page 18

### Horizontal C.F.L. Downlights - (Excludes ballast. To be ordered separately)



DL-2022



DL-2035

Watts	Colour	C/W Glass Code	Size Ø x H (mm)	C/W Glass and Reflector Code	Size Ø x H (mm)
2 x 13W	White	<b>DL-2022-WH-13</b>	160 x 110	<b>ELC-4030-WH-13*</b>	140 x 95
2 x 13W	Satin Nickel	<b>DL-2022-SN-13</b>	160 x 110	<b>ELC-4030-SN-13*</b>	140 x 95
2 x 18W	White	<b>DL-2022-WH-18</b>	230 x 130	<b>ELC-6030-WH-18</b>	180 x 120
2 x 18W	Satin Nickel	<b>DL-2022-SN-18</b>	230 x 130	<b>ELC-6030-SN-18</b>	180 x 120
2 x 26W	Satin Nickel	-	-	<b>ELC-7030-SN-26</b>	240 x 150
2 x 26W	White	<b>DL-2035-WH-26</b>	230 x 230 x 115	*This fitting uses only one 13W lamp	
2 x 26W	Satin Nickel	<b>DL-2035-SN-26</b>	230 x 230 x 115		

Lamp type for above: **PLC-13/18/26**

Lamps to be ordered separately see page 18. For Self Ballast Lamps see page 23.

For Ballast see page 157-159

ELC range



## COMMERCIAL LED SPOTLIGHTS CEILING MOUNT

	Surface Mount			Recessed
Supply Voltage: 230VAC Tilttable: 90° Rotatable: 355° Beam Angle: 36°				
Code	LWQ-001-7W- <sup>*</sup>	LWQ-001-10W- <sup>*</sup>	LWQ-001-12W- <sup>*</sup>	LWQ-003-12W- <sup>*</sup>
Wattage	7W	10W	12W	12W
Lumens	560lm	800lm	960lm	960lm
Size (mm)	Ø100 x 61	Ø100 x 115	Ø100 x 185	Ø100 x 60
Cutout (mm)	-	-	-	Ø95

\* Add Colour to Code: **W** (White), **B** (Black). \* Add Colour Temp to Code: **○ WW** (Warm White) 2700K, **○ CW** (Cool White) 4200K, **○ DL** (Daylight) 6000K

Supply Voltage: 230VAC	Adjustable Focus		Fixed Focus				
Code	8302- <sup>*</sup>	A020-01- <sup>*</sup>	A001-01- <sup>*</sup>	MS-WL003003- <sup>*</sup>	MS-WL003006- <sup>*</sup>	MS-WL004006- <sup>*</sup>	MS-WL004012- <sup>*</sup>
Wattage	9W	9W	13W	3 x 1W (3W)	6 x 1W (6W)	6 x 1W (6W)	12 x 1W (12W)
Beam Angle	Focus 22°-62°	Focus 18°-55°	Fixed 35°	30°	30°	30°	30°
Lumen	850lm	850lm	1045lm	180lm	2 x 180lm	360lm	2 x 360lm
Colour	Black	Silver	Silver	Silver	Silver	Silver	Silver
Size	Ø80 x 90	190 x 80 x 100	Ø90 x 180	105 x 55 x 12	178 x 55 x 121	123 x 63 x 130	213 x 63 x 130

\*Add colour to code: **○ WW** (Warm White) 3000K, **○ CW** (Cool White) 4000K \*Add colour to code: **○ WW** (Warm White) 3000K, **○ CW** (Cool White) 4000K  
**○ DL** (Daylight) 6000K

## LED SPOTS/ DISPLAY LIGHTS

Supply Voltage: 100-240VAC Angle 60°			
Code	L048B- <sup>*</sup>	L046A- <sup>*</sup>	L046C- <sup>*</sup>
Size (mm)	78(H) x 35(Base) x 30Ø	160 x 51 x 112	250 x 61 x 125
Lumen	90lm	180lm	270lm
LEDs	1 x 1W	2 x 1W (2W)	3 x 1W (3W)

\*Add colour to code: **○ WW** (Warm White) 2700K, **○ DL** (Daylight) 6000K

## DISPLAY / POP-UP STAND LIGHTS

Lamps not included.	Supplied with two in a box	Chrome Plated			
Code	E2-DL-006	CT-3521	EL202702-B	EL202702	EL202723
Supply Volts	230VAC	12VDC	230VAC	12VAC/DC	230VAC
Power	150W	50W Max.	1 x 3W	1 x 3W	3 x 1W
Lamp Holder	Rx7s (78mm)	MR16	LED	LED	LED
Size (mm)	590	55 x 50	70 x 140	70 x 170	77 x 425

**NEW**

## 2 WIRE LED TRACK LIGHTS

- WW - 2700K
- CW - 4200K



**Standard LED Track Head** - Input Voltage: 230VAC | CRI > 80

Code	Wattage	Beam Angle	Lumens	Size (mm)	* Add Colour Temp to Code
TLL19-9W-*.*	9W	Fixed 24°	850lm	Ø60 x 90	WW / CW
TLL19-12W-*.*	12W	Fixed 30°	1100lm	Ø90 x 120	WW / CW
8611-311-*.*	30W	Fixed 24°	1600lm	Ø80 x 140	WW / CW
GDD-002-*.*	7W	36°	490lm	Ø47 x 150	WW / CW
371-X2G-*.*	7W x 2	15°	700lm x 2	120 x 125 x 142	WW / CW
GD15A-40-*.*	40W	15°	3200lm	140 x 100 x 230	WW / CW
GD01-H07C-*.*	7W	24°	560lm	100 x 55 x 110	WW / CW

\* Add Colour to Code: **WH** (White), **BK** (Black)  
 \* Add Colour to Code: **W** (White), **B** (Black)

- WW - 2700K
- CW - 4200K



**Commercial LED Track Head** - Input Voltage: 220-240VAC | CRI > 80

Code	Wattage	Beam Angle	Lumens	Size (mm)	* Add Colour Temp to Code
XH-TL-15W-F-*.*	15W	24°	1400lm	60 x 77 x 229	WW / CW
XH-TL-25W-F-*.*	25W	24°	2100lm	71 x 88 x 249	WW / CW
XH-TL-35W-F-*.*	35W	24°	3040lm	83 x 100 x 252	WW / CW
XH-TL-10W-B-*.*	10W	40°	830lm	114 x 172 x 75	WW / CW
XH-TL-20W-B-*.*	20W	40°	1680lm	132 x 177 x 75	WW / CW
XH-TL-30W-B-*.*	30W	40°	2600lm	144 x 180 x 75	WW / CW
XH-TL-15W-E-*.*	15W	15° - 50°	1200-1400lm	Ø62 x 150	WW / CW
XH-TL-25W-E-*.*	25W	15° - 50°	1900-2100lm	Ø90 x 197	WW / CW
XH-TL-35W-E-*.*	35W	15° - 50°	3040-3550lm	Ø90 x 197	WW / CW
XH-TL-45W-E-*.*	45W	60°	4100lm	226 x 248 x 40	WW / CW

\* Add Colour to Code: **W** (White), **B** (Black).

- WW - 2700K
- CW - 4200K



**Linear LED Track Head** - Input Voltage: 230VAC | CRI > 80

Code	Wattage	Beam Angle	Lumens	Size (mm)	* Add Colour Temp to Code
LX-LT-10W-*.*	10W	110°	1300lm	300	WW / CW
LX-LT-20W-*.*	20W	110°	2600lm	600	WW / CW
LX-LT-30W-*.*	30W	110°	3900lm	1000	WW / CW



**Adjustable LED Track Head** - Input Voltage: 230VAC | Tilttable: 90° | Rotatable: 355°

Code	Wattage	Beam Angle	Lumens	Size (mm)	* Add Colour Temp to Code
LWQ-002-7W-*.*	7W	36°	490lm	Ø100 x 61	WW / CW
LWQ-002-10W-*.*	10W	36°	800lm	Ø100 x 115	WW / CW
LWQ-002-12W-*.*	12W	36°	900lm	Ø100 x 185	WW / CW

\* Add Colour to Code: **W** (White), **B** (Black).

LWQ-068-*.*	7W	36°	560lm	Ø40 x 260	WW / CW
-------------	----	-----	-------	-----------	---------

\* Add Colour to Code: **W** (White), **B** (Black).

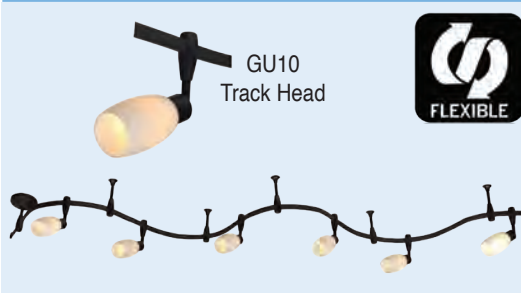

**Flexible Track Light Kit** - Input Voltage: 230VAC

Code	Description
LT-FT5094-4PA	2m Flexible Track Light Kit with - 1 x Floating Canopy - 4 x Rail Supports - 4 x GU10 Track Heads - Middle Connector to join tracks

2 Year warranty on all LED products, unless otherwise specified. Warranty void if adequate surge protection is not installed on LED products. See page 147

## TRACK LIGHT & ACCESSORIES

Track Lighting - Track supplied with End Cap and Power End Cap					Spare End Cap & Power End Cap	
Code 2 Wire	YD-2C-*.**				YD-E-2-*	KTK-V
Code 3 Wire	YD-3C-*.**				YD-E-3-*	YD-F-3-*
Code 4 Wire	YD-4C-*.**				YD-E-4-*	YD-F-4-*
*Add to code: length (meter) 1, 2 or 3. **Add colour to code: ○ W (White), ● B (Black)						
Track Lighting - Track supplied with End Cap and Power End Cap					Spare End Cap & Power End Cap	
Code 2 Wire	KTK-I	KTK-L	KTK-T	KTK-X	YD-E-2-*	KTK-V
Code 3 Wire	YD-I-3-*	YD-L-3-*	YD-T-3-*	YD-X-3-*	YD-E-3-*	YD-F-3-*
Code 4 Wire	YD-I-4-*	YD-L-4-*	YD-T-4-*	YD-X-4-*	YD-E-4-*	YD-F-4-*
*Add colour to code: ○ W (White), ● B (Black).					*Add colour to code: ○ W (White), ● B (Black).	

**Track Light Fitting & Pendant Adaptors** - Universal Adaptors to modify existing tracks to heads | Pendant track adaptors allow pendants to wire to adaptor

	<td> <td> <td>*Add colour to code: ○ W (White), ● B (Black).</td> </td></td>	<td> <td>*Add colour to code: ○ W (White), ● B (Black).</td> </td>	<td>*Add colour to code: ○ W (White), ● B (Black).</td>	*Add colour to code: ○ W (White), ● B (Black).
--	--	--	---	--

## MINI LED TRACK & DISPLAY CABINET LIGHTS

Track - Can be cut to length	Connectors					Fixing Clip
Code	TT-1000	TT-23	TT-24	TT-25	TT-27	TT-37M
Size (mm)	1000 x 11.8 x 9.6H	50	31 x 31H	50 x 31 x 31H	31 x 31 x 31H	12 x 12 x 15H
Description	Track 1m	Straight	L Corner	T Connector	3D Connector	Clip
Live / Dead Ends	End Caps				End Caps	
Code	TT-38C	TT-38D	TT-38	TT-DE1	TT-ECL	TT-ECR
Description	Corner Live	Corner Dead End	Live End	Dead End	End Cap Left	End Cap Right
Heads - Adjustable, Beam Angle 15°	Strips - Beam Angle 15°				LED Cabinet Lights - Supply Voltage: 110 - 240VAC	
Code	TT-32-*	TT-31-*	TT-S250-*	TT-S500-*	LUA2411-1	LUA2411-3
Wattage	1W	1W	9W	9W	1W	3W
Lumens	100lm	100lm	900lm	900lm	90lm	250lm
Size (mm)	Ø31 x 63	Ø18 x 60	250 x 12H	500 x 12H	75 x 19 x 250	68 x 20 x 250
*Add colour to code: ○ WW (Warm White) 3000K, ○ CW (Cool White) 4000K						

COMMERCIAL

LIGHTING

**NEW**

## LED DOWNLIGHT / CABINET LIGHTS

Supply Voltage:  
230VAC



Code	LCS0210R-1-*	LCS0210S-1-*	LCS0310R-1-*	LCS0320R-3-*	LCS0420R-3-*
Power	1W	1W	1W	3W	3W
Lumen	85lm	85lm	85lm	255lm	255lm
Size (mm)	Ø30 x 22	30 x 30 x 22	Ø35 x 25	Ø40 x 25	Ø40 x 25
Cut Out Size (mm)	Ø27	27 x 27	Ø25	Ø30	Ø35

Supply Voltage:  
230VAC



Code	LCS0420S-3-*	LCS0420Q-3-*	LCS0420H-3-*	LCS0420A-3-*	LCS0820R-3-*
Power	3W	3W	3W	3W	3W
Lumen	255lm	255lm	255lm	255lm	255lm
Size (mm)	40 x 40 x 25	Ø40 x 25	44 x 44 x 30	Ø44 x 30	Ø55 x 42
Cut Out Size (mm)	35 x 35	Ø35	35 x 35	Ø35	Ø43



Code	LCS0820S-3-*	LCS1425R-3-*	LCS1425R-5-*	LCS1425S-3-*	LCS1425S-5-*
Power	3W	3W	5W	3W	5W
Lumen	255lm	255lm	425lm	255lm	425lm
Size (mm)	55 x 55 x 42	Ø50 x 55	Ø50 x 62	50 x 50 x 55	50 x 50 x 62
Cut Out Size (mm)	43 x 43	Ø42	Ø42	42 x 42	42 x 42

\*Add colour to code: ○ WW (Warm White) 3000K, ○ CW (Cool White) 4200K

Supply Voltage:  
230V/50Hz.  
Constant current  
driver to be ordered  
separately  
CLD-B3503 (pg 888)

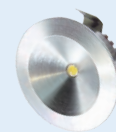

Code	QL201B20-*	QL101B11-*	LWQ-009-*	QL102B02-*	QL103B32-*
Power	1W	1W	12W	1W	1W
Lumen	83lm	83lm	240lm	83lm	83lm
Size (mm)	Ø52	Ø52	Ø41 x 89	Ø41.5	Ø41.5
Cut Out Size (mm)	Ø42	Ø42	Ø35	Ø35	Ø35

\*Add LED colour to code: ○ WW (Warm White) 2700K, ○ CW (Cool White) 4200K, ● BL (Blue), ● Y (Yellow), ● GN (Green), ● R (Red)

### Mini Aluminium LED Downlights

Supply Voltage:  
230V/50Hz.  
Constant current  
driver to be ordered  
separately  
CLD-B3503 (pg 888)

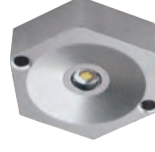

Code	EL212003-*	EL212004-*	EL212005-*	EL202732-B-*	EL212007-*
LED	1W (350mA)	1W (350mA)	1W (350mA)	1W (700mA)	1W (350mA)
Req PSU	CLD-B3503	CLD-B3503	CLD-B3503	LED-N12-9W	CLD-B3503
Size (mm)	Ø23.5 x 16.5	Ø23.5 x 16.5	Ø30 x 9	Ø49	Ø30
Cut-out Size (mm)	-	-	-	Ø40	Ø24

\*Add LED colour to code: ○ W (Cool White) 4200K, ● BL (Blue), ● Y (Yellow), ● GN (Green), ● R (Red)

## LED CABINET LIGHTS

	12VDC 	12VDC 	 c/w Driver	Supply Voltage: 230V/50Hz c/w LED Driver 
<b>Code</b>	<b>EL202744-*</b>	<b>EL200867-*</b>	<b>LS0841-1-*</b>	<b>LED-3199-*</b>
LED	1.2W	0.5W	3W	3W
Req PSU	12V	12V	Included	Included
Size (mm)	Ø60 x 9	Ø40	Ø57 x 7.5	Ø44 x 45
Cut-out Size (mm)	-	Ø34	-	-
*Add LED colour to code	○ W (Cool White) 4200K, ● BL (Blue), ● Y (Yellow), ● GN (Green), ● R (Red)			○ WW (Warm White) 2700K, ○ CW (Cool White) 4200K

Supply Voltage: 100-240VAC c/w LED Driver, Transformer & Switch			
<b>Code</b>	<b>LS0834-*</b>	<b>LS0833-*</b>	<b>LS0839A-KIT-*</b>
Wattage	3W x 4	1.28W	28.5W x 3
Lumens	40lm x 4	30lm	120lm x 3
Size	Ø75 x 4H	Ø75 x 19H	Ø69 x 23H
<b>IP Rating</b>	<b>IP20</b>	<b>IP20</b>	<b>IP20</b>

			 Power Supply Remote	
<b>Code</b>	<b>LS0841-3-*</b>	<b>LS-CG2301YM-3-PW</b>	<b>LS-CG2301FM-3-PW</b>	<b>P60W4CH</b>
Wattage	3W x 3	1.5W x 3	1.5W x 3	9W
Lumens	148lm x 3	80lm	80lm	700lm
Size	Ø57 x 7.5H	Ø65 x 15	75 x 75 x 20	Ø60 x 8
<b>IP Rating</b>	<b>IP20</b>	<b>IP20</b>	<b>IP20</b>	<b>IP20</b>

\*Add colour to code: ○ WW (Warm White) 2700K, ○ CW (Cool White) 4200K

IP20 - Linkable 80-260VAC			
<b>Code</b>	<b>QL-6022A-*</b>	<b>QL-6023A-*</b>	<b>QL-6025A-*</b>
Size (mm)	239L x 51.5W x 29H	360L x 51.5W x 29H	605L x 51.5W x 29H
Lumen	120lm	180lm	300lm
Watts	2 x 1W	3 x 1W	5 x 1W

## LED HINGE LIGHT

			<b>Code</b>	<b>CHL-A49A/2</b>	<b>CH-A04/2</b>
<b>CHL-A49A/2</b>	<b>CH-A04/2</b>	<b>Installed</b>	Lumens	16lm	Soft Close Hinge (Set of 2)
			Integrated	On / Off	
			Sensor	Trigger	
			Operating Voltage	12V	
			Application	Cupboards	
			Spare Battery	<b>AC531</b>	



NEW

# CABINET LIGHTS



230VAC

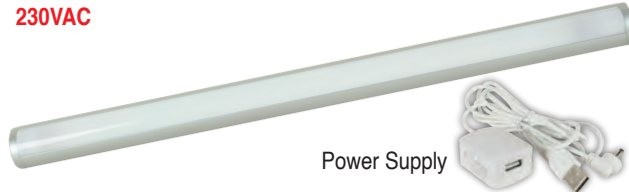

Power Supply

**Portable Makeup Light** - Input Voltage: 5VDC USB | 3 Level Touch Dimming | RA > 80 | **IP40** | Colour Temperature: 6000K | Mounting Suction Cup Included

Code	Wattage	Lumens	Size (mm)
PI4A1CH	4W	180lm	Ø14 x 206

Complete with Power Supply 230VAC / 5VDC



230VAC

- CW - 4200K
- DL - 6500K



Power Supply

**Smart Sensor Light - Auto On & Off** - Input Voltage: 5VDC | PIR & Daylight Sensor | Sensing Distance > 3m | Adjustable Time Delay | Colour Temperature: 6000K | **IP20** | Magnetic Mounting Strip Included

Code	Wattage	Lumens	Size (mm)
M3062CH-DL	4W	180lm	315 x 60 x 30

Complete with Power Supply 230VAC / 5VDC



230VAC

- CW - 4200K
- DL - 6500K



Power Supply

**Smart PIR Cabinet Light** - Input Voltage 100 - 240VAC | PIR Sensor | Sensing Distance < 3m | 2 Minute Delay Off | Colour Temperature: 6000K | **IP20** | Mounting Kit Included

Code	Wattage	Lumens	Size (mm)
M45A1CH-DL	11W	850lm	450 x 39 x 10

Complete with Power Supply 230VAC / 5VDC



5VDC USB



Charger

**Mini Drawer LED Light** - Rechargeable 330mAh Lithium Battery | Input Voltage: 5V (USB) | Auto On/Off | Very Small, Portable & Easy to Install | Magnetic Mounting Kit Included

Code	Wattage	Lumens	Size (mm)
MMSL1/2	0.6W	36lm	68 x 28 x 11

Complete with USB Cable

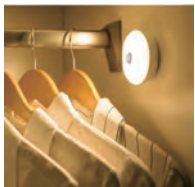

5VDC USB



Charger

**Rechargeable PIR Cabinet Light** - Beam Angle 120° | Battery Capacity 1200mAh | PIR Sensor | Switch Mode: Left - off, Right - manual mode, Middle - PIR | 12 Second Delay Off | Colour Temperature 3000K | **IP20** | Mounting Kit Included

Code	Wattage	Lumens	Size (mm)
M80P2CH	2W	150lm	Ø80 x 28.5

Complete with USB Cable

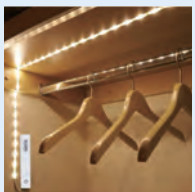

Battery Operated



**Battery Operated PIR Wardrobe Light** - 4 x AAA Battery (Not Included) | PIR Sensor | Sensing Distance 2m | Switch Mode: Upwards - PIR, Downwards - Manual Mode | 12 Second Delay Off | Colour Temperature: 4000K | **IP20** | Mounting Tape Included

Code	Wattage	Lumens	Size (mm)
M21M1CH	2.4W	200lm	1000 x 8 x 2.3

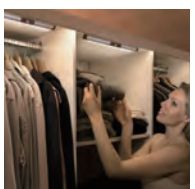

5VDC USB



Charger

**Rechargeable PIR Wardrobe Light** - Battery Capacity 900mAh | PIR Sensor | Sensing Distance 2m | Switch Mode: Left - PIR, Right - Manual, Middle - Off | Colour Temperature: 4000K | **IP20** | Magnetic Mounting Kit Included

Code	Wattage	Lumens	Size (mm)
M33A1GB	1.5W	120lm	330 x 345 x 15

Complete with USB Cable



5VDC USB

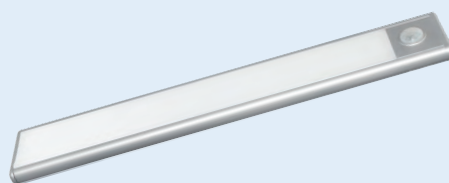

**Ultra Slim Cabinet Light** - 5V USB Charging | Aluminium Alloy | **IP20** | c/w Built-in Magnet for Easy Mounting, Mounting Clips & USB Charging Cable | Colour Temp: 4200K | c/w Motion Sensor

Code	Wattage	Lumens	Battery	Size (mm)
DL-6110-23	1.4W	140lm	900mAh	230 x 40 x 9
DL-6110-40	3W	300lm	1500mAh	400 x 40 x 9
DL-6110-60	3.2W	320lm	2000mAh	600 x 40 x 9

## BATTERY OPERATED CABINET LIGHTS

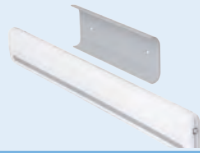

**Cupboard & Wardrobe Light** - Battery Operated Linear Light | Integrated 6 SMD LED's | 4000K | Integrated On/ Auto/Off Switch | Magnet Operated | 6 x AA Batteries (Not Included) | c/w Mounting Bracket and Screws.

Code	Wattage	Lumens	Size (mm)
<b>BOCL02W</b>	2W	130lm	400 x 43 x 27



**Drawer Light** - Battery Operated Linear Light | Integrated 3 SMD LED's | 4000K | On/Off Switch Magnet Operated | 3 x AA Batteries (Not Included) | c/w Mounting Bracket and Screws.

Code	Wattage	Lumens	Size (mm)
<b>BOCL03W</b>	3W	150lm	250 x 44 x 27

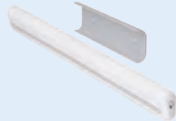

**Counter Top & Wardrobe Light** - Battery Operated Linear Light | Integrated 12 SMD LED's | Integrated On/Off Switch | Magnet Operated | 12 x AA Batteries (Not Included) | c/w Mounting Kit and Screws.

Code	Wattage	Lumens	Size (mm)
<b>BOCL01W</b>	4W	260lm	465 x 58 x 27



**Ceiling Light** - Battery Operated Spot Light | Integrated 9 SMD LED's | 4000K | On/Off Operated and push front cover | 4 x C Batteries (Not Included) | c/w Mounting Kit and Screws

Code	Wattage	Lumens	Size (mm)
<b>BOCL05W</b>	3W	150lm	Ø144 x 43



**Ceiling Light** - Battery Operated Spot Light | Integrated 1 SMD LED | 4000K | Light & Motion Sensor with On/ Auto/Off Switch | 3 x AA Batteries (Not Included) | c/w Mounting Kit and Screws.

Code	Wattage	Lumens	Size (mm)
<b>BOCL04W*</b>	4W	260lm	Ø96 x 30



\* For a set of 3 add /3 to code

## LED UNDERCOUNTER / CABINET LIGHTS

### Low Profile LED undercounter Lighting

Supply Voltage : 12VDC. Power Supply excluded



### Features

- Polycarbonate lens and aluminium body
- Linkable, c/w power cord and mounting accessories
- 30 000 hours average lifespan
- Max length in series 1.5m
- Cool White (4000K)
- For DC power supply see page 108-109.

### Touch Switch



**S02-PD**

On/Off Switch  
Dimming

Code	Size (mm)	Power	No. of LED's	LED Type	Lumen	Spare Link
<b>L300S25</b>	300 x 25 x 9	3W	42	3528 SMD	292lm	<b>S25-LINK</b>
<b>L500S25</b>	500 x 25 x 9	5W	72	3528 SMD	475lm	
<b>L800S25</b>	800 x 25 x 9	8.5W	120	3528 SMD	760lm	
<b>L1000S25</b>	1000 x 25 x 9	10.5W	144	3528 SMD	880lm	

### Cupboard Door Switch



**S02-IR**

Photo-electric Sensor  
Used on doors  
Light will switch on when door opens

### Low Profile LED undercounter Lighting

For corner application

Supply Voltage : 12VDC. Power Supply excluded



### Features

- Polycarbonate lens and aluminium body
- Linkable, c/w power cord and mounting accessories
- 30 000 hours average lifespan
- Max length in series 1.5m
- Cool White (4000K)
- For DC power supply see page 108-109.

### Motion Sensor Switch



**S02-PR**

PIR Motion Sensor  
Distance 1-3m  
Time Delay 1min/5min  
Selectable

Code	Size (mm)	Power	No. of LED's	LED Type	Lumen	Spare Link
<b>L300T27</b>	300 x 27 x 11	3W	42	3528 SMD	292lm	<b>T27-LINK</b>
<b>L500T27</b>	500 x 27 x 11	5W	72	3528 SMD	475lm	
<b>L800T27</b>	800 x 27 x 11	8.5W	120	3528 SMD	760lm	
<b>L1000T27</b>	1000 x 27 x 11	10.5W	144	3528 SMD	880lm	

## LED DC LIGHT FITTINGS

				
<b>Code</b>	<b>C2-83</b>	<b>C2-94</b>	<b>C2-116</b>	<b>C2-147</b>
LED Colour	Warm White	White	Pure White	White
Watts	1.5W	1.5W	1W	1.5W
Volts	12-24VDC	12-24VDC	9-30VDC	12-24VDC
Size (mm)	Ø80 x 45	Ø80 x 48	115 x 77 x 48	Ø78 x 29
Control	Built in rocker switch On-Off control 350° swivel/40° angle adjustment	Built in rocker switch On-Off control 350° swivel/40° angle adjustment	Built in rocker switch On-Off control 350° eye-ball rotating light angle	Built in rocker switch On-Off control
				
<b>Code</b>	<b>C2-59C</b>	<b>C2-146</b>	<b>C2-103</b>	<b>C2-138</b>
LED Colour	White	White	White	Cool White
Watts	1.5W	1.5W	3W	4(4 x 1W)
Volts	12-24VDC	12-24VDC	12-24VDC	9-30VDC
Size (mm)	139 x 92 x 21	139 x 92.5 x 21	250 x 87 x 35	249 x 108 x 31
Control	Built in rocker switch On-Off control	Built in rocker switch On-Off control		Built in rocker switch On-Night-Off or On-Off
				
<b>Code</b>	<b>C2-123-CL2-*</b>	<b>C2-123-CL4-*</b>	<b>C2-64CAL</b>	<b>C2-613</b>
LED Colour	Pure White	Pure White	White	White
Watts	2(2 x 1W)	4(4 x 1W)	1.2(4 x 0.5W)	3(10 x 0.3W)
Volts	9-32VDC	9-32VDC	12-24VDC	12VDC
Size (mm)	95 x 30 x 33	275 x 30 x 33	187 x 30 x 30	230 x 24 x 11
Description	180° Pivot. Built in rocker switch for On-Off	180° Pivot. Built in rocker switch for On-Off	180° Pivot. Built in rocker switch for On-Off	

\*Add fitting colour to code: ○W (White), ●B (Black)

2 Year warranty on all LED products, unless otherwise specified. Warranty void if adequate surge protection is not installed on LED products. See page 147

LIT

© ACDC Dynamics

COMMERCIAL

LIGHTING

# LED INTERIOR DC LIGHTING

Light Colour: White Supply Voltage: 9-33VDC					
<b>Code</b>	<b>C2-212</b>	<b>C2-217</b>	<b>C2-218</b>	<b>C2-220</b>	<b>C2-221</b>
No. of LED's	42 x SMD	68 x SMD	60 x SMD	64 x SMD	60 x SMD
Watts	3W	4W	4W	4W	4W
Size (mm)	Ø130 x 12	Ø180 x 12	200 x 120 x 19	185 x 150 x 12	220 x 100 x 12
Control	Touch Control (On-Dimmer-Off)				

## DC Fluorescent Light Fittings - For battery installations eg. caravans etc.

Lamp included Cool White 4000K			5700K 		
<b>Code</b>	<b>C2-76 12V</b>	<b>C2-78 12V</b>	<b>C2-89 12V-LED</b>	<b>C2-92 12V</b>	<b>C2-91 12V</b>
<b>Code</b>	<b>C2-76 24V</b>	<b>C2-78 24V</b>	<b>C2-89 24V-LED</b>	<b>C2-92 24V</b>	
Lamp Type	T5	T5	LED	T8	T5
Watts	1 x 8W (FLT5-8)	2 x 8W (FLT5-8)	0,5W x 18Pcs	1 x 15W (FLT8-15)	1 x 8W (FLT5-8)
Size (mm)	410 x 68 x 35	411 x 68 x 35	485 x 65 x 45	591 x 65 x 45	340 x 50 x 28
Fitting Colour	White	White	Satin	Satin	White
Control	Rocker switch, On-Off				

Lamp included Cool White 4000K				12-24VDC 5700K 	12VDC 5700K 
<b>Code</b>	<b>C2-68 12V</b>	<b>C2-50 12V</b>	<b>C2-113 12V</b>	<b>C2-62-LED</b>	<b>C2-95-LED</b>
	<b>C2-68 24V</b>	<b>C2-50 24V</b>			
Lamp Type	2G7	2G7	2D	LED	LED
Watts	1 x 13W (PL-13-WW)	1 x 7W (PL-7-WW)	1 x 6W (2D-16-CW)	6W	8W
Size (mm)	254 x 70 x 37.5	206 x 86 x 42.2	Ø250 x 47.5	186 x 179 x 37	200 x 120 x 40
Fitting Colour	Satin	White	Satin	White	White
Control	On: Always on, Door: Door open Light on, Off: Always off			Rocker switch, On/Off	

<i>Ideal for steps, interior or exterior courtesy lighting and storage areas</i>	<b>DC LED Light Fittings</b>		<b>Accessories</b>
	<b>Code</b>	<b>C2-98-*</b>	<b>C2-104-*</b>
Volts	12-24VDC	12-24VDC	*Add <b>BK</b> (Black) or <b>CH</b> (Chrome) bezel for <b>C2-98</b> . Surface mounting. LED Lamp not included.
Size (mm)	90L x 24.7W x 14.3H	176L x 24.7W x 14.3H	

\*Add colour to code: ● **R** (Red), ● **BL** (Blue), ● **GN** (Green), ● **Y** (Yellow), ● **CW** (Cool White)

NEW

# NON-WEATHERPROOF LED STRIP LIGHTS IP20

**2 Year Warranty!**



LD60W-R3528

**5 Year Warranty!**



5Y-LD60W-R2835

### 2835 Chipset

Standard Range 12VDC | 5m | Cutting length every 3rd LED | c/w Self-Adhesive Backing | Max Length Connected in series 5m

Code	No. of LEDs	Max Power	Lumens	*Add Colour to Code
IMG-R30*-S	30/0.5m	1.5W/m	750lm	
LD30W-R3528*-*	30/m	2.4W/m	750lm	●R / ●GN / ●BL / ●Y / ○WW / ○DL
LD60W-R3528*-*	60/m	4.8W/m	1500lm	
LD120W-R3528*-*	120/m	9.6W/m	3000lm	
LD240W-R3528*-*	240/m	19.2W/m	6000lm	

Professional Range 24VDC | 10m | RA 80 | Cutting length every 6 LEDs | c/w Self-Adhesive Backing | Max Length connected in series 10m

5Y-LD30W-R2835*-*	30/m	3.6W/m	780lm	●R / ●GN / ●BL / ●Y / ○WW / ○DL
5Y-LD60W-R2835*-*	60/m	7.2W/m	1560lm	
5Y-LD120W-R2835*-*	120/m	12W/m	3120lm	

**2 Year Warranty!**



LD60W-R5050

**5 Year Warranty!**



5Y-LD30W-R5050

### 5050 Chipset

Standard Range 12VDC | 5m | Cutting length every 3rd LED | c/w Self-Adhesive Backing | Max Length Connected in series 5m

Code	No. of LEDs	Max Power	Lumens	*Add Colour to Code
LD30W-R5050*-*	30/m	7.2W/m	540lm	●R / ●GN / ●BL / ●Y / ○WW / ○DL / ●●●○ RGBW
LD60W-R5050*-*	60/m	14.4W/m	1080lm	
LD120W-R5050*-*	120/m	28.8W/m	2160lm	

Professional Range 24VDC | 10m | RA 80 | Cutting length every 6 LEDs | c/w Self-Adhesive Backing | Max Length connected in series 10m

5Y-LD30W-R5050*-*	30/m	5W/m	660lm	●R / ●GN / ●BL / ●Y / ○WW / ○DL / ●●● RGB
5Y-LD60W-R5050*-*	60/m	10W/m	1320lm	

### COB Strip

24VDC | 5m | Cutting length 25mm | c/w Self-Adhesive Backing | Max length connected in series 10m | 180° Beam Angle | CRI 90 | Even light distribution | No hot spots | Ideal for Architectural, Archway Bridge, Auditorium, Signage & Channel lettering

Code	No. of LEDs	Max Power	Lumens	*Add Colour to Code
LD-COB-R*-*	336/m	10W/m	1100lm	●R / ●GN / ●BL / ○WW / ○DL
LD-COB-R-RGB	840/m	10W/m	1100lm	

### Accessories

Code 2 Wire	Code 4 Wire	Description
LD-COB-R-2PC	LD-COB-R-4PC	Power connector
LD-COB-R-2MC	LD-COB-R-4MC	Middle connector
LD-COB-R-2JC	LD-COB-R-4JC	Jumper connector



Power Connector



Middle Connector



Jumper Connector

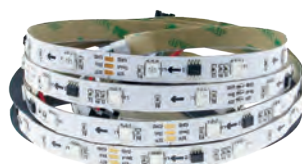

### WS2811 Addressable LED Strip

12VDC | 5m | Cutting length every 3rd LED | c/w Self-Adhesive Backing | Max length in series 5m | WS2811 is an addressable LED strip controlled by external IC WS2811 | Each IC controls 3 leds. Each pixel is individually addressable

Code	No. LEDs	Max Power	Lumen	Colour
LD-WS2811-RGB	60	14.4W/m	1000-1440lm	RGB

## WEATHERPROOF LED STRIP LIGHTS IP54

2 Year Warranty!

5 Year Warranty!



### 2835 Chipset

Standard Range 12VDC | 5m | Cutting length every 3rd LED | c/w Self-Adhesive Backing | Max Length Connected in series 5m

Code	No. of LEDs	Max Power	Lumens	*Add Colour to Code
IMG-OR30*-SF	30/0.5m	1.5W/m	750lm	●R / ●GN / ●BL / ●Y / ○WW / ○DL
IMG-WR30*-SF	30/0.5m	1.5W/m	750lm	
LD30W-W3528-*	30/m	24W/m	750lm	
LD60W-W3528-*	60/m	4.8W/m	1500lm	
LD120W-W3528-*	120/m	9.6W/m	3000lm	

Professional Range 24VDC | 10m | RA 80 | Cutting length every 6 LEDs | c/w Self-Adhesive Backing | Max Length connected in series 10m

5Y-LD30W-W2835-*	30/m	3.6W/m	780lm	●R / ●GN / ●BL / ●Y / ○WW / ○DL
5Y-LD60W-W2835-*	60/m	7.2W/m	1560lm	

2 Year Warranty!

5 Year Warranty!



### 5050 Chipset

Standard Range 12VDC | 5m | Cutting length every 3rd LED | c/w Self-Adhesive Backing | Max Length Connected in series 5m

Code	No. of LEDs	Max Power	Lumens	*Add Colour to Code
IMG-OR15*-3SF	30/0.5m	1.5W/m	750lm	●R / ●GN / ●BL / / ●Y / ○WW /
IMG-WR5*-3SF	30/0.5m	1.5W/m	750lm	
LD30W-W5050-*	30/m	24W/m	750lm	○DL / ●●●●○
LD60W-W5050-*	60/m	4.8W/m	1500lm	RGBW

Professional Range 24VDC | 10m | RA 80 | Cutting length every 6 LEDs | c/w Self-Adhesive Backing | Max Length connected in series 10m

5Y-LD30W-W2835-*	30/m	3.6W/m	780lm	●R / ●GN / ●BL / ●Y / ○WW / ○DL / / ●●● RGB
5Y-LD60W-W2835-*	60/m	7.2W/m	1560lm	

## WEATHERPROOF LED STRIP LIGHTS IP65



DL-ECN25-VC

DL-ECN25-MC

DL-ECN25-FP



DL-ECN25

DL-ECN25-SO

DL-ECN25-PCG

### Flexible LED Tube

24VDC | 5m | Flexible | No Specific cutting length | 360° Illumination | Tube diameter 23mm

Code	No. of LEDs	Max Power	Lumens	*Add Colour to Code
DL-ECN25-*	168 x 2/m	14.4w/m	1400lm	●R / ●GN / ●BL / ●Y / ○WW / ○CW / ○DL

### Accessories

Code	Description
DL-ECN25-FP	Straight Power out Cap and End Cap
DL-ECN25-SO	Side Power out Cap and End Cap
DL-ECN25-MC/5	Arched shaped PC Mounting clip/5(Pack)
DL-ECN25-PCG	1m Arched Shaped PC Profile
DL-ECN25-VC	1m vertical PC Ceiling mount Tube c/w metal head cap, metal end cap, 1m Hanging wire

COMMERCIAL

LIGHTING

NEW

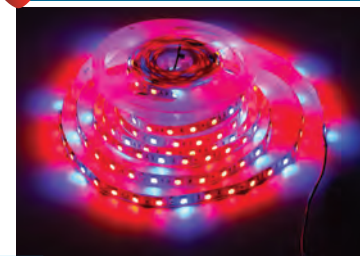

## LED PLANT GROW STRIPS IP65

Supplied with 230VAC Power Adaptor | LED Strip is 24VDC | Lumens: 10-22lm | Viewing Angle: 120° | Blue (Wave Length: 455-465nm) - Good for Photosynthesis | Red (Wave Length: 660-665nm) - Peak Wavelength for Photosynthesis & Photoperiodism - Good for Blooming & Fruits | Red/Blue in one Chip: Red:Blue = 5:1 (Suitable for most Plant Growing)

Code	Description	No. LEDs	Max Power/m	Length
HH-SRB60W	Red/Blue 5:1	60/m	14W/m	10m
HH-SRB120W	Red/Blue 5:1	120/m	28W/m	10m
HH-SR-60W	Red	60/m	14W/m	10m
HH-SB-60W	Blue	60/m	14W/m	10m

## ANTI-GLARE LED STRIP IP65

Input Voltage: **24VDC** - Even Light Distribution | Ideal for Architectural, Archway, Bridge, Auditorium, Signage & Channel Letter Lighting | Dimensions: 12 x 4.5mm | Supplied with front and back Power Connectors

Code	No. LEDs	Max Power/m	Lumen	Viewing Angle	Length (mm)
AG210-W2835-*	210/m	12W	1300lm	120°	5000

\*Add colour to code: ○ WW (Warm White), ○ CW (Cool White), ○ DL (Daylight)

### Accessories

Code	Description
AG210-PC	Male and Female Connector
AG210-CL	Mounting Clips   Pack of 10



## COB LED STRIP LIGHT IP65

24VDC | 5m | Cutting length 25mm | c/w Self-Adhesive Backing | Max length connected in series 10m | 180° Beam Angle | CRI 90 | Even light distribution | No hot spots | Ideal for Architectural, Archway Bridge, Auditorium, Signage & Channel lettering

Code	No. of LEDs	Max Power	Lumens	*Add Colour to Code
LD-COB-W-*	336/m	10W/m	1100lm	●R / ●GN / ●BL / ○WW / ○DL
LD-COB-W-RGB	840/m	10W/m	1100lm	●●●RGB

### Accessories

Code 2 Wire	Code 4 Wire	Description
LD-COB-W-2PC	LD-COB-W-4PC	Power connector
LD-COB-W-2EC	LD-COB-W-4EC	End Cap

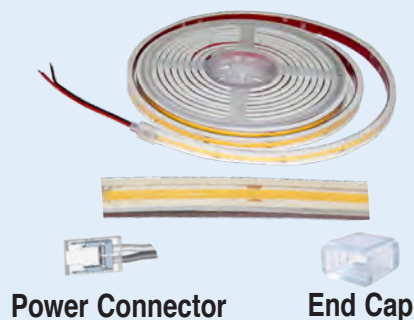

Power Connector

End Cap

## FLEXIBLE WALL WASHER STRIP LIGHT IP67

24VDC | 5m | 30° beam angle | Designed to replace traditional wall washers | Small flexible and light weight and easy to install

Code	No LED's	Max Power/m	Lumens	*Add colour to code
FW48-W30D-*	48/m	18W	1915	WW/CW/DL
FW42-W30D-RGB	42/m	8W	540	RGB

### Accessories

Code	Description
FW-AP	1m Aluminium channel
FW-AM	Angle bracket - Can adjust Angle
FW-MC	Metal clip for mounting
FW-SC	Silicone clip for mounting
VHB3M-18	3m Tape - Supplied in 1m Length



FW-AM

FW-AP

FW-MC

## WEATHERPROOF LED STRIP LIGHTS IP68

**2835 Chipset** - 12VDC | 5m | Silicone gel insulated tube | Min cutting length every 3rd LED | Max length connected in series 5m

Code	No. of LEDs	Max Power	Lumens	*Add Colour to Code
WP30W-W3528-*	30/m	2.4W/m	650lm	●R / ●GN / ●BL / ●Y / ○WW / ○DL
WP60W-W3528-*	60/m	4.8W/m	1320lm	

**5050 Chipset** - 12VDC | 5m | Silicone gel insulated tube | Min cutting length every 3rd LED | Max length connected in series 5m

Code	No. of LEDs	Max Power	Lumens	*Add Colour to Code
WP30W-W5050-*	30/m	7.2W/m	540lm	●R / ●GN / ●BL / ●Y / ○WW /
WP60W-W5050-*	60/m	14.4W/m	1080lm	○DL / ●●●RGB
WP120W-W5050-*	120/m	28.8W/m	2160lm	

### Accessories

Code	Description	Pack Size
SP108F	Plastic Mounting Clip	100
SP109F	End cap with no holes	10
SP110F	End cap with 2 holes	10
SP112F	90g Silicone Gel	10



SP108F

SP110F

SP109F

SP112F

NEW

## STAIRWAY LIGHTING CONTROLLERS



MLU300-IR-WR

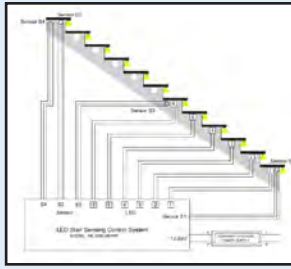

ELU300-D1-IR

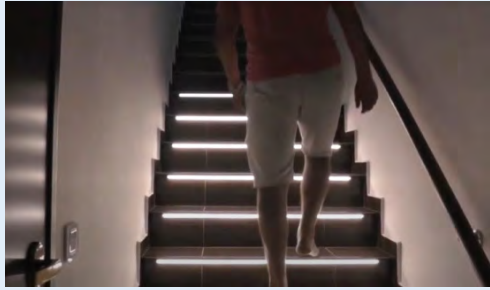
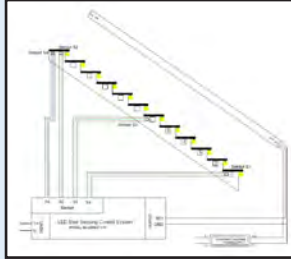

**DMX Stair Case Lighting** - The DMX controller is used for Dynamic Lighting of the stairs. The back light is switched on with the subsequent step, depending on motion direction: ascending or descending

**Controller**

Code	Input/Output Voltage	Input Signal Channels	Output Channels	Size
MLU300-IR-WR	12-24VDC	4	50 Max	168 x 39 x 30

**Decoder**

Code	Input/Output Voltage	Input Signal Channels	Output Channels	Size
MLU500-3-8A	12-24VDC	4	3	168 x 39 x 30
MLU500-4-8A	12-24VDC	4	4	168 x 39 x 30
MLU500-5-8A	12-24VDC	4	5	168 x 39 x 30

**Pixel Handrail Lighting** - The LED Handrail controller is used to create a meteor effect on the handrail. The effect will depend on motion direction: ascending or descending. Only Compatible with WS2811 IC LED Strip

**Controller**

Code	Input/Output Voltage	Input Signal Channels	Output Channels	Size
ELU300-D1-IR	12VDC	4	1	168 x 39 x 30

**Accessories**

Code	Description
MLS008-PIR	Motion Sensor - Used to trigger direction
MLS008-BRC	Day light sensor
IR-K2	IR Remote Control - Program Scenes

NEW

## SMART LED STRIP LIGHT DIMMER & CONTROLLERS IP20



ES-TDS01



ES-WDS01



**Touch (On / Off & Dimming)** - Metal body | Touch time < 2 seconds, on / off function | Touch time > 2 seconds, dimming will gradually rise to full brightness alternatively lower brightness

**Wave (On / Off & Dimming)** - Wave your hand in front of dimmer | Waving time < 2 seconds, on / off function | Touch time > 2 seconds, dimming will gradually rise to full brightness alternatively lower brightness

Code Touch	Code Wave	Input Voltage	Function	Max. Power
ES-TDS01	ES-WDS01	DC12V / DC24V	Single Colour	36W at DC12V 72W at DC24V



IR Sensor

**IR Sensor Switch** - Normally mounted in wardrobe and drawer | Open door , light ON | Close door , light OFF

Code	Input Voltage	Function	Max. Power
ES-IRS03	DC12V / DC24V	Single Colour	36W at DC12V 72W at DC24V



ES-BDS01

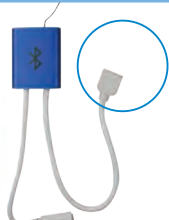

ES-BDS02

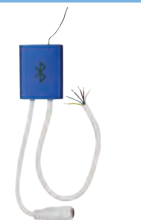

ES-BDS03



**Bluetooth Controller** - Bluetooth 4.1 | Support IOS & Android | Download "Wilight" from Apple Store or Google Play | Search the connected light | Control the light by "Wilight" App

**Wi-Fi Controller** - Remote control LED lamps by App | Support 16 million colour selection and brightness control | Timing function, set schedule to switch on/off lights | Colour change with rhythm of music on smart device | Works with Amazon Alexa & Google home, control lights by voice

Code Bluetooth	Code Wi-fi	Input Voltage	Function	Max. Power
ES-BDS01	ES-WFD01	DC12V / DC24V	Single Colour	36W at DC12V 72W at DC24V
ES-BDS02	ES-WFD02	DC12V / DC24V	RGB	36W at DC12V 72W at DC24V
ES-BDS03	ES-WFD03	DC12V / DC24V	RGBW	36W at DC12V 72W at DC24V



ES-WFD01



ES-WFD02



ES-WFD03



COMMERCIAL

LIGHTING



## CONTROLLERS FOR LED STRIPS

Code	MINI-RGB	MINI-RGBW	MINI-SINGLE	MINI-AMP	MINI-WIRELESS-RGB	MINI-WIRELESS-RGBW	RGB-LINK/5
Description	12VDC Colour Controller	12VDC Single Colour Controller Dimmer	12VDC Single Colour Controller Dimmer	RGB LED Amplifier to be used every 5 meters	RF Wireless RGB LED Controller	RF Wireless RGBW LED Controller	4 Pin RGB Link
Watts	Max 144W	Max 144W	Max 144W	-	Max 144W	Max 144W	-

Code	SP106F	RGBW-AMP	GT-2601	WD95-DC12	WLD95-DC12	DC-PWM-96W-LED
Supply Volts	12VDC	12 - 24VDC	12VDC	12VDC	12-24VDC	9VDC-48VDC
Description	RGB Amplifier 48W (4A)	RGBW Amplifier 4 Channel, 6A per Channel	RGB Controller 6A per Channel	Wired dimmer 96W (8A)	Wireless dimmer 48W (4A)	DC PWM Bell Press Dimmer - Ideal for LED Strip Light I for zone controlling see dimmer section in accessories. No minimum load I Suitable for 12VDC and 24VDC strip LED's I Digital control provides accurate and flicker free dimming to very low intensity
Size (mm)	104 x 65 x 24	115 x 72 x 42	105 x 75 x 29	89 x 59 x 35	65 x 39 x 22	36 x 36 x 12

Code	SP107F	FUT-005N	FUT-022
Supply Volts	12VDC	12/ 24VDC	12-24VDC
Description	RGB Controller with remote for preloaded programs (Fading & Flashing effects) 45 Watts (4A) per channel. 9 Changing Patterns.	LED RGB Controller with remote control. Dimming function & 15 colour changing patterns set via remote. 6A per channel. Direct colour selection via colour wheel.	Colour temperature adjustable and dimmable. 6A per Channel.

## SMART DEVICES

### Google Home Mini

Powered by the Google Assistant so you can ask it questions and tell it to perform various tasks. Enjoy your entertainment and control your Smart Home.

Code	Wireless Network	Colour	Size (mm)
HOME-MINI	WIFI & Bluetooth	White / Grey	Ø98 x 42

### Echo Dot

A hands-free, voice controlled device that uses Alexa to play music, control smart home devices and more

ECHO-DOT	WIFI & Bluetooth	Black	Ø84 x 32
----------	------------------	-------	----------



HOME-MINI



ECHO DOT

NEW

## DIGITAL & MUSIC STRIP LIGHTS



**LED Magic Strip IP65** - c/w Controller and Power Supply

83 Functions | Colour Chasing | Colour Mixing | Dimming | View Angle: 120°

Code	No. of LEDs/m	Max Power	Lumen/m	Length
MAG60-5050-RGB	30	7.2W/m	RGB: (R:64 G:128 B:80)	5m



**Music Activated LED Strip RGB Kit IP65** - c/w Music Controller, RGB Controller and 230VAC Power Supply

Code	No. LEDs / m	Max Power / m	Length
MUS30-5050-RGB	30	5W / m	5m

NEW

## SMART LED STRIP KIT



Smart Wi-Fi LED Strip kit - 5m Length

Code	Function	No. of LEDs/m	Watts/m	Max Power
ES-WFD01-5M-CW/WW	CCT Adj	120/m	4.8W/m	24W
ES-WFD02-5M-RGB	RGB	30/m	4.8W/m	24W
ES-WFD03-5M-RGBW	RGBW	48/m	4.8W/m	24W



WiFi Control

App Control

Remote Switching

Set Timers & Schedules

Dimmable

Music for RGB/RGBW

Colour RGBW Adjustable

## LED FLEX STRIP KITS - 5M LENGTHS

IP20



c/w power supply & ON/OFF switch

IP65



c/w dimmer & CW/WW control

IP65



c/w RGB remote controller

IP20



c/w RGB remote controller

Code	LS1761P-*	LS1778-CW/WW	LS1702P-RGB	LS1702P-RGBW	NW1702P-RGB	NW1702P-RGBW
Size (mm)	5000L x 8W x 4H	5000L x 14W x 4H	5000L x 14W x 4H	5000L x 14W x 4H	5000L x 14W x 4H	5000L x 14W x 4H
Lumen	900 - 1050lm	1400lm	N/A	N/A	N/A	N/A
LEDs	60/m (total 300Pcs 24W) 3528	60/m (total 300Pcs 48W) 3528	30/m (total 150Pcs 36W) 5050	30/m (total 150Pcs 36W) 5050	30/m (total 150Pcs 36W) 5050	30/m (total 150Pcs 36W) 5050
Colour	*Add colour to code: ○ DL (5000k), ○ WW (3200k), ● R (Red), ● GN (Green), ● BL (Blue), ● Y (Yellow)	○ CW (Cool White), ○ WW (Warm White)	●●● RGB (Red, Green, Blue)	●●○ RGBW (Red, Green, Blue, White)	●●● RGB (Red, Green, Blue)	●●○ RGBW (Red, Green, Blue, White)

COMMERCIAL LIGHTING

NEW

## HEXAGON LED TILES



**Tiles** - Wifi enabled | Touch Control | Music Sync | Screen Mirror | 100lms per panel | CRI >80 | RGBW 1200K-6500K, + 16 million colours | Dimmable | Mounting Type : double sided Tape or Mounting Screws | Compatible with Apple, Amazon, Google, IFTTT, Smarthings | Create any patterns by interlinking

Code	Max Power Supply Power	Max Energy Consumption per Panel	Max Power per Power Supply	Max Panels per controller	Dimmension
NL42-0001MX-P	42W	2W	21 hexagons per 42W PSU	500 Hexagons	Ø230x10mm

### Accessories

Code	Description
NL42-0002HX-C	Smart Controller
NL26-0001	Remote Control
NC04-0051	230VAC 42W Power Supply
NC04-0070	Linking Cables (3 per pack)
NC04-0042	Rigid Links (10 per pack)



NL42-0001MX-P



L26-0001



NL42-0002HX-C



NC04-0051



NC04-0070



NC04-0042

**NEW**

## LED UNDER BED STRIP WITH MOTION SENSOR



FST-CDB

**Rechargeable** - USB Port for Charging | Working Time 3hrs | Motion Sensor Distance: 2-5m | Time Adjustable 15sec - 6min

Code	Wattage	Lumens	LED p/m	Length
FST-CDB-1M-*	2.4W	240lm	30	1m

\* Add colour to code: ○ **WW** (Warm White) 2700K, ○ **CW** (Cool White) 4200K, ○ **DL** (Daylight) 6000K

**Direct 230V** - Dimmable | Motion Sensor Distance: 2-5m | Time Adjustable 30s - 380s | Colour Temperature: Warm White 2700K

Code	Wattage	Lumens	LED p/m	Length
BL60-W3528-WW	2.8W	260lm	45	1.5m
BL60-W3528-WW/2	2.8W	260lm	45	2 x 1.5m



BL60-W3528-WW/2



BL60-W3528-WW

**NEW**

## USB MULTI COLOUR MOOD LIGHT FOR TV IP20

USB Power 5VDC | Easy Assembly | Remote Control | Two Available Options, 2 LED Strips or 4 LED Strips per Controller

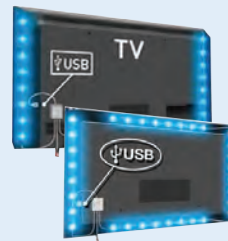

Code	Wattage	Lumens	LED/m	Length (mm)
TV30-R5050-RGBW/2	4.8W/m	300lm	32	2 x 500 (2 x Strips)
TV30-R5050-RGBW/4	9.6W/m	600lm	32	4 x 500 (4 x Strips)

**NEW**

## LED TAIL LIGHT STRIP IP67

Input Voltage: 12VDC | 4 Pin tow adaptor connection | Flexible design | Adventure Proof | LED Signals: Driving mode - Glows bright red, Left Turn - Flash on the left, Right Turn - Flash on the right, Break - Beam dark red across, Reverse - Beam White across.



Code	Wattage	LED p/m	Size (mm)
TG60-2835-R/W	1.2W	60	13 x 6 1244

**NEW**

## UNDER DASH LIGHTING KIT

Input Voltage: 12-24VDCVDC | c/w Cigarette Lighter Adaptor | 4 x Waterproof LED Strips - RGB | Wireless IR Remote & Controller | Dimmable | Colour Scenes



Code	Description	Wattage	LEDs	Size (mm)
UD-5050-RGB	Colour Changing c/w controller	18W	18 x 4	300 x 10
UD-5050-RGBM	Colour Changes to the Beat of the Music c/w controller	12W	12 x 4	210 x 10

2 Year warranty on all LED products, unless otherwise specified. Warranty void if adequate surge protection is not installed on LED products. See page 147

NEW

## GAZEBO LIGHT KIT

Input Voltage: 5VDC | 160° Beam Angle | Colour Temperature: 5000K | c/w Mounting Clips | 4 x 3 Meter light strips | On/Off Switch | Easy to Assemble



*Ideal for Camping!*

Code	Description	Wattage	Lumens	Size (mm)
SG-TLKA1	Gazebo 5VDC LED Kit	4 x 3W	1500lm	4000 x 3000

NEW

## CAMPING LED STRIP LIGHT IP68



Input Voltage: 5V / 12VDC | One Side with USB, other side with waterproof DC female connector with cigarette & battery clip | Two mounting methods, hook & velcro | Dimmable | 4 Different colour methods; Warm White, Cool White, R+G+B (SOS) & Amber to keep insects away.

Code	Wattage	Lumens	LED/m	Length (mm)
KU-CAMPSTRIP-12VDC	10W	500lm	60 + 30	1000mm

## LED STRIP CONNECTION SYSTEM

	LED Strip	Right Bend	Left Bend	Tee	Cross
Code	SL101-*-* SL102-* -RGB	SL-CL11-* SL-CL21-RGB	SL-CL12-* SL-CL22-RGB	SL-CT1-* SL-CT2-RGB	SL-CC1-* SL-CC2-RGB
No. of LEDs	9/18	2	2	3	3
Power	1.4W/2.8W	0.5W	0.5W	0.5W	0.5W
Size (mm)	250/500 x 9.8	45 x 21	45 x 21	56 x 45	56 x 56

\* Add size to code: 250mm or 500mm. \*Add colour to code: ● R (Red), ● Y (Yellow), ● GN (Green), ● BL (Blue), ○ PW (Pure White)

### Application

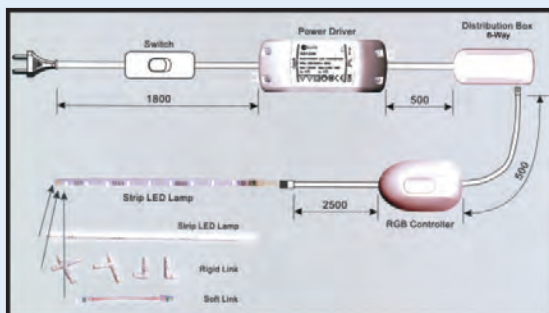

Code	Description
ED1230	Power driver 12V 25W max
SL-C10	RGB controller (10 functions)
SL-DB6-C	6-Way distribution box for use with single colour LED strips
SL-DB6-RGB	6-Way distribution box for use with RGB LED strips
SL-DB12	12-Way distribution box for use with LED spot lights
SL-SC	Soft link for connecting LED strips to each other (80mm long)
SL-IC	Initial connector for connecting LED strips to power driver (2500mm long)



COMMERCIAL

LIGHTING

NEW

## FLEXIBLE SILICONE PROFILE

	Top Side Emitting	Top Side Emitting	Top Side Emitting
<b>Code</b>	<b>SIL-5X11-FRONT/10M</b>	<b>SL-0513A</b>	<b>SIL-10X10-FRONT/10M</b>
Length	10m	5m	10m
LED Strip Dimensions	8mm	10mm	5mm
Power Sleeve	<b>SL-0511-SPS</b>	<b>SL-0513A-SPS</b>	<b>SL-1010A-SPS</b>
End Cap	<b>SIL-5X11-CLIP/10</b>	<b>SL-0513A-EC</b>	<b>SL-1010A-EC</b>
Mounting Clips	<b>SIL-5X11-CAP/5</b>	<b>SL-0513A-MC</b>	-
30mm Alu. Profile	-	-	<b>SL-1010A-AP</b>
	3 Side Emitting	3 Side Emitting	320° Emitting
<b>Code</b>	<b>SIL-10X10-3SIDES/10M</b>	<b>SL-1018</b>	<b>SL-1023</b>
Length	10m	5m	5m
LED Strip Dimensions	5mm	10mm	10mm
Power Sleeve	<b>SL-1010B-SPS</b>	<b>SL-1018-SPS</b>	<b>SL-1023-SPS</b>
End Cap	<b>SIL-10X10-CAP</b>	<b>SL-1018-EC</b>	<b>SL-1023-EC</b>
Mounting Clips	<b>SIL-10X10-CLIP</b>	-	-
30mm Alu. Profile	<b>SIL-10X10-FLEX-PROFILE/M</b>	<b>SL-1018-AP</b>	<b>SL-1023-AP</b>

## LED PROFILES

Aluminium "U" profile and accessories  
**Does not c/w LED Strip**  
 LED Strip to be Ordered Separately



Code	UPRO-3.1M	UPRO-CWC	UPRO-CWF	UPRO-CFC	UPRO-CFF	UPRO-EC
Description	"U" profile	Cover with wings - clear	Cover with wings - frosted	Flush cover - clear	Flush cover - frosted	Endcap for Profile with strain relief
Supplied as	3.1m Length	3.1m Length	3.1m Length	3.1m Length	2.5m Length	-
Material	Aluminium	PMMA	PMMA	PMMA	PMMA	-

Profile and covers to be ordered separately.

Monza and Nizza Profiles below and also **MZA** profiles above can be mounted using the "U" Profile

**Does not c/w LED Strip**  
 LED Strip to be Ordered Separately



Code	MZAPRO-3.1M	NIZPRO-3.1M	LINEPRO-2M	MONPRO-3.1M	CANPRO-2M
Description	Monza Profile - For 8mm strips	Nizza Profile - For 8mm strips	Half Round Profile - For 8mm strips	Monaco Profile - For 4mm strips	Cannes Profile - For 8mm strips
Size H x W x L (mm)	14 x 11 x 3100	12 x 11 x 3100	20 x 12 x 2000	5 x 7 x 3100	10 x 10 x 2500
Mounting Clips	<b>MZAPRO-CL</b>	<b>NIZPRO-CL</b>	-	<b>MONPRO-CL</b>	<b>CANPRO-CL</b>
End Caps	<b>MZAPRO-EC</b>	<b>NIZPRO-EC</b>	-	<b>MONPRO-EC</b>	<b>CANPRO-EC</b>
Material	PMMA	PMMA	PMMA	PMMA	PMMA

2 Year warranty on all LED products, unless otherwise specified. Warranty void if adequate surge protection is not installed on LED products. See page 147

**NEW**

# LED PROFILES

## LED Recessed Aluminium Profile

Supplied without LED Strip - to be Ordered Separately

End Caps and Mounting clips to be ordered separately

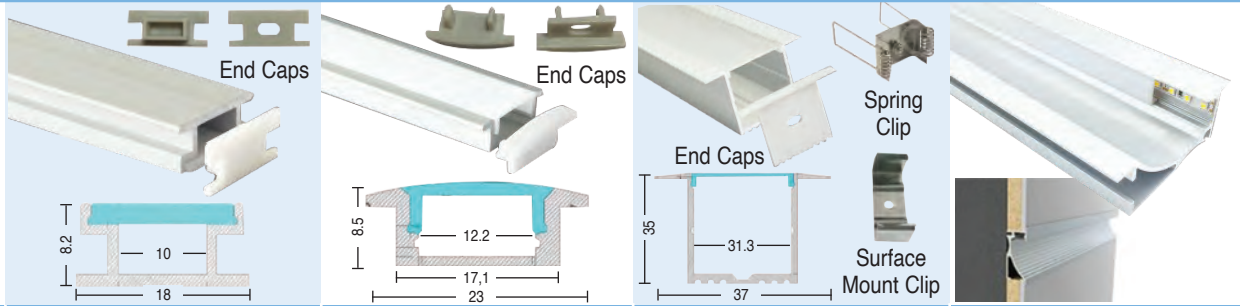

Code	PFFLL01	PFRLS05	HL-BAPL017	HL-BAPL023
Length	2m	2.5m	2m	2m
Mounting Clips	-	-	HL-BAPL017-CL	-
Spring Clips	-	-	HL-BAPL017-SC	-
End Caps	PFFLL01-EC	PFRLS05-EC	HL-BAPL017-EC	HL-BAPL023-EC

## LED Surface Aluminium Profile

Supplied without LED Strip - to be Ordered Separately

End Caps and Mounting clips to be ordered separately

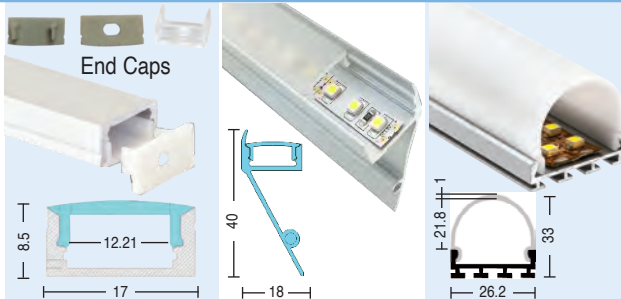

Code	PFRLS06	HL-BAPL030	LUXX-3R
Length	2.5m	2m	2m
Mounting Clips	PFRLS06-CL	HL-BAPL030-CL	LUXX-3R-CL
End Caps	PFRLS06-EC	HL-BAPL030-EC	LUXX-3R-EC

## LED Stairs Aluminium Profile

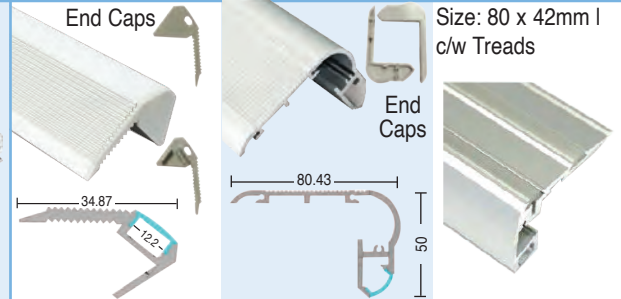

Code	HL-BAPL022	HL-BAPL047	PFSTR01
Length	2.5m	2.5m	2m
Mounting Clips	-	-	PFSTR01-CL
End Caps	HL-BAPL022-EC	HL-BAPL047-EC	PFSTR01-EC

## LED 90° Aluminium Profile

Supplied without LED Strip - to be Ordered Separately

End Caps and Mounting clips to be ordered separately

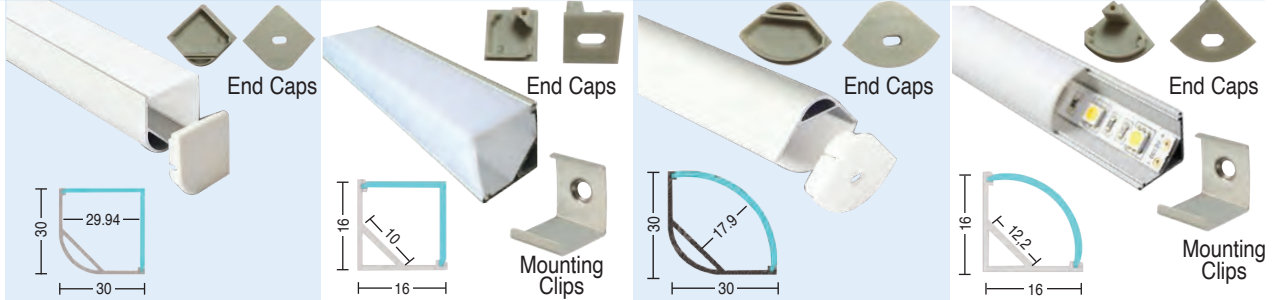

Code	HL-BAPL015	PFSC01	HL-BAPL016	PFSC02
Length	2.5m	2m	2.5m	2.5m
Mounting Clips	HL-BAPL015/6-CL	PFSC01-CL	HL-BAPL015/6-CL	PFSC02-CL
End Caps	HL-BAPL015-EC	PFSC01-EC	HL-BAPL016-EC	PFSC02-EC

## LED Glass Aluminium Profile

Supplied without LED Strip - to be Ordered Separately  
End Caps and Mounting clips to be ordered separately



Code	HL-BAPL044C
Length	2m
Mounting Clips	-
End Caps	HL-BAPL044C-EC

## Wardrobe Aluminium Profile



Code	HS-LEDAP37
Length	3m
Mounting Clips	HS-LEDAP37-MC01 / HS-LEDAP37-MC02
End Caps	HS-LEDAP37-EC

**COMMERCIAL**
**LIGHTING**

NEW

# PROFILES

## Plaster Construction Aluminium Profile

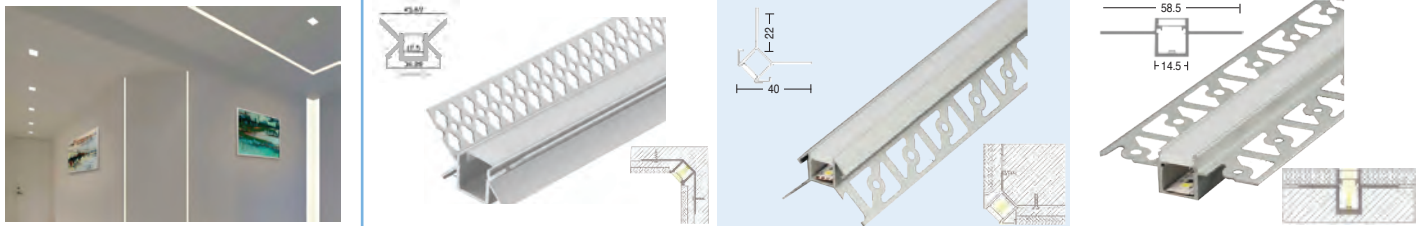

<b>Code</b>	<b>HS-LEDAP3303</b>	<b>HS-LEDAP3302</b>	<b>HS-LEDAP3301</b>
Length	3m	3m	3m
End Caps	<b>HS-LEDAP3303-EC</b>	<b>HS-LEDAP3302-EC</b>	<b>HS-LEDAP3301</b>
<b>Code</b>	<b>HS-LEDAP3304</b>	<b>HS-LEDAP1201</b>	<b>HS-LEDAP1202</b>
Length	3m	3m	3m
End Caps	<b>HS-LEDAP3304-EC</b>	<b>HS-LEDAP1201-EC</b>	<b>HS-LEDAP1202-EC</b>

Supplied without LED Strip - to be Ordered Separately | End Caps to be Ordered Separately

## LED PROFILES C/W LEDS

### Single Colour or Colour Changing

Supply voltage: 12VDC  
Supplied c/w required mounting accessories  
Maximum length connected in series: 2000mmØ

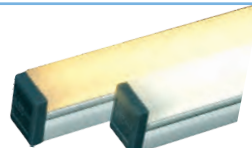

<b>Code</b>	<b>VIS5*-A*</b>	<b>MZA*-A*</b>	<b>IMO2*-A*</b>
Size H x W (mm)	15 x 18	14 x 11	20 x 12
*Specify Length (mm)	255 (2.5W) 505 (4.5W) 1005 (9.0W)	272 (2.5W) 522 (4.5W) 1022 (9.0W)	260 (2.5W) 510 (4.5W) 1010 (9.0W)
Connection	Wire	Wire	Wire
Material	Aluminium	PMMA	PMMA

### Single Colour or Colour Changing

Supply voltage: 12VDC  
Supplied c/w required mounting accessories  
Maximum length connected in series: 2000mmØ

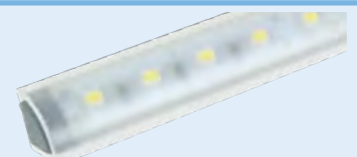
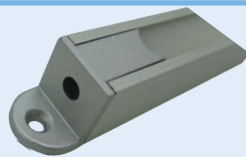

<b>Code</b>	<b>VIS6*-A*</b>	<b>MON2*-A*</b>	<b>CAN*-A*</b>
Size H x W (mm)	15 x 14	5 x 7	10 x 10
*Specify Length (mm)	250 (2.5W) 500 (4.5W) 1000 (9.0W)	266 (2.5W) 516 (4.5W) 1016 (9.0W)	270 (2.5W) 520 (4.5W) 1020 (9.0W)
Connection	Jack	Wire	Wire
Material	Aluminium	PMMA	PMMA

\*Specify Colour: ○ CW (Cool White), ○ WW (Warm White), ●●● RGB (Colour Changing). For Power Supplies and RGB controllers please see page 93

NEW

## LED SHELF TAG



**Standard Strips** - Input Voltage: 24VDC | LED Chip: 3020 | CRI > 80 |  
Colour Temperature: 5500K | Beam Angle: 180° Front Side Up, 120° Back Side Down

Code	Wattage	Lumens	Size
<b>LST-1185-PW</b>	11W	935lm	1000 x 48.6 x 12

**With Butcher Strip** - Input Voltage: 24VDC | LED Chip: 3020 | CRI > 80 |  
Colour Temperature: 5500K | Beam Angle: 180° Front Side Up, 120° Back Side Down

Code	Wattage	Lumens	Size
<b>LST-1185-PW-BL</b>	11W	935lm	1000 x 48.6 x 12

2 Year warranty on all LED products, unless otherwise specified. Warranty void if adequate surge protection is not installed on LED products. See page 147

LIT

© ACDC Dynamics

COMMERCIAL

LIGHTING

## SIDE VIEW LED STRIP LIGHTS IP20

**SMD Side View Non-Weatherproof - 12VDC**

- LED Type SMD335
- With self-adhesive backing

- Cutting length every 3rd LED
- Max pcs connected on same supply 2 x 5m



Code	No. of LEDs/m	Max Power	Lumen/m	LED Spacing	Length
SV60W-R335-*	60/m	4.8W/m	R:70 Y:80 G:120 B:60 CW:180 WW:180	16.7mm	5m
SV120W-R335-*	120/m	9.6W/m	R:140 Y:160 G:240 B:120 CW:360 WW:360	8.3mm	5m

\*Add colour to code: ●R (Red), ●GN (Green), ●Y (Yellow), ●BL (Blue), ○CW (4000k), ○WW (3200k)

## SIDE VIEW LED STRIP LIGHTS IP54

**SMD Side View Weatherproof - 12VDC**

- LED Type SMD335
- With self-adhesive backing

- Cutting length every 3rd LED
- Max pcs connected on same supply 2 x 5m



Code	No. of LEDs/m	Max Power	Lumen/m	LED Spacing	Length	PCB colour
SV60W-W335-*	60/m	4.8W/m	R:70 Y:80 G:120 B:60 CW:180 WW:180	16.7mm	5m	White
SV120W-W335-*	120/m	9.6W/m	R:140 Y:160 G:240 B:120 CW:360 WW:360	8.3mm	5m	White

\*Add colour to code: ●R (Red), ●GN (Green), ●Y (Yellow), ●BL (Blue), ○CW (4000k), ○WW (3200k)

## ZIG-ZAG LED FLEXIBLE STRIP 12VDC IP20

Foldable & bendable shaping | LED type SMD 2835 | With self-adhesive tape |  
Cutting length every 3rd LED



Code	Max Power	Lumens	No. of LEDs	Length
ZZ60W-R2835-*	6.0W/m	480-660lm	60/m	5m
ZZ48W-R5050-RGBW ●●●○	15.38W/m	-	48/m	5m

\*Add colour to code: ○WW (Warm White - 3000K), ○DL (Daylight - 5000K), ●R (Red), ●G (Green), ●B (Blue)

## STRIP LIGHT CONNECTORS

**Accessories for Non-Weatherproof SMD Strips**

Code	Description	Pack Size
IMG-LJQ/10	2-Wire double sided connector for IMG-R30 strips	10
IMG-JXQ/10	2-Wire single-sided connector for IMG-R30 strips	10
IMG-ACC2-2/10	2-Wire white connector	10
SP2104	12V Male plug	1
SP2105	12V Female plug	1
IMG-ACC4-1	4-Wire connector for RGB strips	1
SL-CON16	DC female connector with 2 male connectors	1

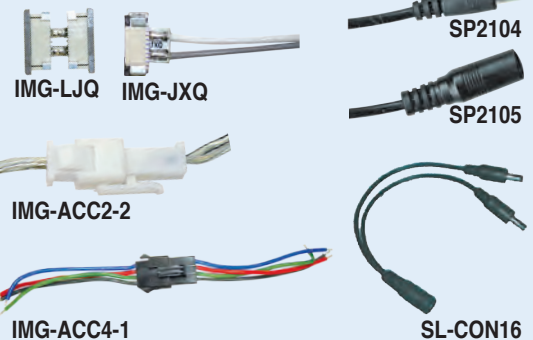

**Accessories for Weatherproof SMD Strips**

Code	Description	Pack Size
SP104F	4 Wire 12V Male Plug	1
SP105F	4 Wire 12V Female Plug	1
IMG-ACC2-1F/5	Mini waterproof 2-wire connector IP65	5
IMG-ACEP2-F/10	Weatherproof end cap	10
IMG-ACHH-1/10	Flat transparent Mounting Clip for weatherproof LED strips	10
SL-CON11	2-Wire waterproof connector	1
SL-CON12	4-Wire waterproof connector for RGB colour strips	1



**Wiring Diagram for use of RGB Amplifier**

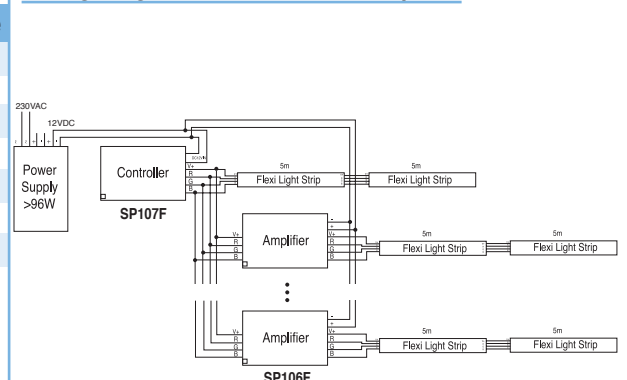



# RIGID LED STRIP LIGHTS

**IP65**

Supply Volts 24VDC  
Aluminium Housing

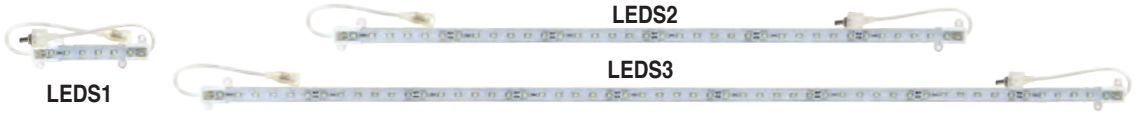

Size	100mm			600mm			900mm		
Colour	Code	Watts	Lumens	Code	Watts	Lumens	Code	Watts	Lumens
● Red	LEDS1-R	0.48W	36lm	LEDS2-R	2.88W	216lm	LEDS3-R	4.32W	324lm
● Green	LEDS1-G	0.48W	36lm	LEDS2-G	2.88W	216lm	LEDS3-G	4.32W	324lm
● Yellow	LEDS1-Y	0.48W	36lm	LEDS2-Y	2.88W	216lm	LEDS3-Y	4.32W	324lm
● Blue	LEDS1-B	0.48W	36lm	LEDS2-B	2.88W	216lm	LEDS3-B	4.32W	324lm
○ White	LEDS1-W	0.48W	36lm	LEDS2-W	2.88W	216lm	LEDS3-W	4.32W	324lm

**SMD Bars Non-Weatherproof** - open type Rigid P.C.B I Supply Volts 12VDC I LED Type 3528



Size	500 x 8mm			
Code	Colour	LEDs	Lumen per LED	Total Watts
IMG-B30R-S	● Red	30	2	1.2W
IMG-B30G-S	● Green	30	3.6	1.2W
IMG-B30Y-S	● Yellow	30	2	1.2W
IMG-B30B-S	● Blue	30	1.7	1.2W
IMG-B30PW-S	○ Pure White	30	4.4	1.2W
IMG-B30WW-S	○ Warm White	30	4.4	1.2W

**Weatherproof SMD Bars IP65** - Aluminium Housing I Supply Volts 12VDC I LED Type 3528 I With adhesive tape on back



Size	510 x 10mm			
Code	Colour	LEDs	Lumen per LED	Total Watts
IMG-B30R-SF	● Red	30	2	1.2W
IMG-B30G-SF	● Green	30	3.6	1.2W
IMG-B30Y-SF	● Yellow	30	2	1.2W
IMG-B30B-SF	● Blue	30	1.7	1.2W
IMG-B30PW-SF	○ Pure White	30	4.4	1.2W
IMG-B30WW-SF	○ Warm White	30	4.4	1.2W

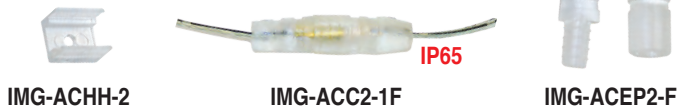

**Accessories**

IMG-ACHH-2/10	Mounting clip/ 10
IMG-ACC2-1F/5	Mini waterproof 2-wire connector/ 5
IMG-ACEP2-F/10	Mini waterproof end-cap/ 10

**Tri-Chip (High Intensity Pure White)** - open type Rigid P.C.B I Supply Volts 12VDC I LED Type 5050 I Non-weatherproof

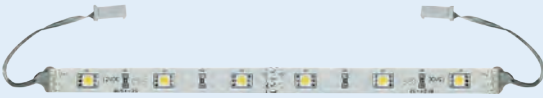

Size	500 x 11.7mm		
Code	LEDs	Lumen per LED	Total Watts
IMG-B15CW-3S	15	17	3.6W



**Accessories - per pack of 10**

Code	Description
IMG-ACHH-4/10	Mounting Clip for IMG-B30X-S
IMG-ACC2-2/10	2-wire white connector
IMG-ACHH-5/10	Mounting clip for IMG-B15-3S

**Slim Type SMD Bar Pure White** - open type Rigid P.C.B I Supply Volts 12VDC I LED Type 3528 I Non weatherproof



Size	500 x 4 x 3.5mm		
Code	LEDs	Lumen per LED	Total Watts
SABL-45S3528-W	45	4.4	7.2W

**Slim Type SMD Bar** - open type Rigid P.C.B I Supply Volts 12VDC I LED Type 3020 I Non-weatherproof



Size	300 x 4 x 3mm			
Code	Colour	LEDs	Lumen per LED	Total Watts
SBL-24S3020-R	● Red	24	1.26	1.44W
SBL-24S3020-Y	● Yellow	24	1.26	1.44W
SBL-24S3020-B	● Blue	24	0.47	1.44W
SBL-24S3020-G	● Green	24	2.2	1.44W
SBL-24S3020-W	○ White	24	4.4	1.44W



**LED Noble Light IP65** - Aluminium Housing I Linkable I Supply voltage 12 VDC I LED Type 5050 I Size: 17.4W x 11.4Hmm I 50 000hrs life time I Can be directly connected to each other or via a connection cable I For power supply and RGB controller see page 93.

**Accessories** (included in pack)



Code	Colour	LEDs	Lumen	Length	Power	Max units in series
NL24-WW	○ Warm White	24	252lm	500mm	4.5W	10
NL24-PW	○ Pure White	24	312lm	500mm	4.5W	10
NL24-RGB	● ● ● RGB	24	220lm	500mm	4.5W	10
NL48-WW	○ Warm White	48	576lm	1000mm	9W	5
NL48-PW	○ Pure White	48	624lm	1000mm	9W	5
NL48-RGB	● ● ● RGB	48	440lm	1000mm	9W	5

2 Year warranty on all LED products, unless otherwise specified. Warranty void if adequate surge protection is not installed on LED products. See page 147

## LED FLEX STRIP KITS

Supply Voltage:  
100-240VAC  
Kit complete with  
transformer and  
ON/OFF Switch  
Blister Packed

LED rigid



LED Flex x 2 (Black)



LED Flex x 3

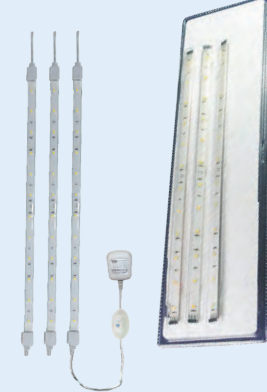

LED Flex  
RGB only



c/w colour remote

Code	LS1739-*	LS1732-*	LS1732H-*	LS1756K-RGB
Size (mm)	460(L) x 17.5(W) x 3(H)	307(L) x 10(W) x 3(H)	307(L) x 10(W) x 3(H)	2000(L) x 14(W) x 4(H)
Lumen	280lm	80lm	80lm	9lm/ LED
LEDs	6	12 x 2	12 x 3	60
IP Rating	<b>IP65</b>	<b>IP44</b>	<b>IP44</b>	<b>IP44</b>

\*Add colour to code: ○ CW (Cool White), ○ WW (Warm White)

## LED RIGID STRIP KITS

### LED Strip Kits - Rigid P.C.B.

Supply Voltage:  
100-240VAC  
Kit complete  
with transform-  
er and ON/OFF  
Switch.  
Blister Packed



Code	LS1769-1-*	LS1769-4-*	LS1779-30-*	LS1779-50-*
Size (mm)	300L x 12W x 8.5H	300L x 12W x 8H	311.5L x 10.5W x 4H	511.5L x 10.5W x 4H
Lumen	180lm	100lm	120lm x 2	200lm
LEDs	27	15 x 4	10 x 2	30
IP Rating	<b>IP44</b>	<b>IP44</b>	<b>IP65</b>	<b>IP65</b>

\* Add colour to code: ○ CW (Cool White), ○ WW (Warm White), ● R (Red), ● BL (Blue), ● GN (Green), ● Y (Yellow)

Supply Voltage:  
100-240VAC  
Kit complete  
with transform-  
er and ON/OFF  
Switch  
Blister Packed

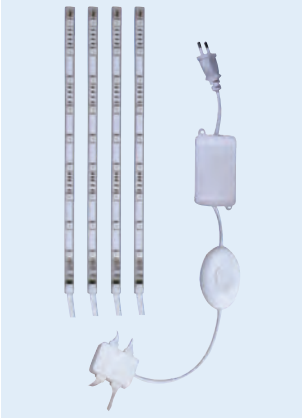

Code	LS1105-CW	EL206763-K-RGB	EL206764-K-*	LS1731-*
Size (mm)	400L x 150	260L x 9.5W x 7H	272L x 8.6W x 6H	305L x 15W x 13.5H
Lumen	35lm	-	-	105lm x 2
LEDs	44 x 5	9 x 4	9 x 4	15 x 2
IP Rating	<b>IP65</b>	<b>IP20</b>	<b>IP20</b>	<b>IP44</b>
Colour	Cool White only	RGB only		

\*Add colour to code: ○ DL (Daylight), ○ WW (Warm White)

## LED STRIP LIGHTING

### Piranha

Supply Voltage:  
c/w transformer  
230/12VDC

- Open PC Housing
- With self-adhesive backing



- PC Housing
- With self-adhesive backing



- PC Housing
- With self-adhesive backing
- c/w mounting clips



Code	HLI00702-*	HLI00802-*	HLI00601-*
Size	426L x 13W x 14Dmm	450L x 17W x 17Dmm	1000L x 22W x 22Dmm
LEDs	21 x 0.08W (1.6W)	21 x 0.08W (1.6W)	70 x 0.06W (4.2W)
IP Rating	<b>IP20</b>	<b>IP20</b>	<b>IP65</b>
Lumen	60	60	210
Kit includes	3Pcs + Transformer	3Pcs + Transformer	230VAC direct supply

\* Add colour to code: ○ **CW** (Cool White), ○ **WW** (Warm White), ● **R** (Red), ● **BL** (Blue), ● **GN** (Green), ● **Y** (Yellow)

## FLEXIBLE LED STRIP LIGHT ON EXTENSION REEL - IP65



Input voltage: 230VAC | c/w power connector | 1000lm per meter | 6500K | Ideal for work, functional and decorative lighting.

Code	Max Wattage	Length
HV120-REEL-15M	150W	15m
HV120-REEL-25M	250W	25m
HV120-REEL-50M	500W	50m

## 230VAC LED STRIP LIGHTS

### Blister Packed IP67



### Long Lengths IP67

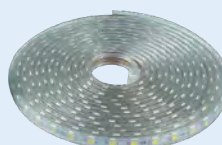

*\*Note: Rope light can be cut every meter, and re-attached using middle connectors*

LED Type	1m Code	5m Code	10m Code	50m Code	Watts/m
3528/60/1m	HV60W-W3528-1M-*	HV60W-W3528-5M-*	HV60W-W3528-10M-*	HV60W-W3528-50M-*	4.8W/m
5050/30/1m	HV30W-W5050-1M-*	HV30W-W5050-5M-*	HV30W-W5050-10M-*	HV30W-W5050-50M-*	7.2W/m
5050/60/1m	HV60W-W5050-1M-*	HV60W-W5050-5M-*	HV60W-W5050-10M-*	HV60W-W5050-50M-*	14.4W/m

\*Add colour to code: ● **R** (Red), ● **GN** (Green), ● **Y** (Yellow), ● **BL** (Blue), ○ **DL** (5000k), ○ **WW** (3200k), ●●● **RGB** (Only for 10M & 50M)

\*Add colour to code: ● **R** (Red), ● **GN** (Green), ● **Y** (Yellow), ● **BL** (Blue), ○ **DL** (5000k), ○ **WW** (3200k), ●●● **RGB** (Only for 10M & 50M)

### Long Lengths Accessories



Code	HV-WIRE-3528	HV-WIRE-5050	HV-WIRE-RGB
Description	Power cord, 100m max for 3528 long length	Power cord, 50m max for 5050 long length	Power cord for RGB strips c/w basic controller

Code	HV-RGB-RC	HV-CON-3528/5	HV-CON-5050/5	HV-CON-RGB/5
Description	Multifunction RGB controller with remote control	Middle connector for 3528 strips	Middle connector for 5050 strips single colour	Middle connector for RGB strips
10pcs per pack				
Code	HV-EC-3528/10	HV-EC-5050/10	HV-CLIP-3528/10	HV-CLIP-5050/10
Description	End cap for 3528 long length	End cap for 5050 long length	Mounting clips for 3528 strips	Mounting clips for 5050 strips

2 Year warranty on all LED products, unless otherwise specified. Warranty void if adequate surge protection is not installed on LED products. See page 147

# LED SIGNAGE BACK LIGHTING

NEW

## ST2 Premium Range - IP65

5 Year Warranty

Supply Voltage 12VDC | Epistar SMD 2835 | Over Moulded | 160° View Angle



Code	Power/PC	Lumen/PC	Max Qty/Series	Dimensions (mm)	Spacing between modules	Length for 10 modules
BV-ST2-2-**	0.72W	44lm	30 Pcs	52 x 14 x 5.5	100mm	± 1620mm
BV-ST2-3-**-*	0.72W	66lm	30 Pcs	75.4 x 14 x 5.5	120mm	± 2074mm

\*Add Colour to code: ○DL (Daylight 6500K), ●Y (Yellow), ●R (Red), ●G (Green), ●BL (Blue)

\*Add Number of Modules to code: /10 (10 Pcs), /30 (30 Pcs)

## ST6 Premium Range - IP65

4 Year Warranty

Supply Voltage 12VDC | Epistar SMD 5730 High Lumen Performance | over moulded | 160° View Angle



Code	Power/PC	Lumen/PC	Max Qty/Series	Dimensions (mm)	Spacing between modules	Length for 10 modules
BV-ST6-2-**	1.44W	80-90lm	30 Pcs	57.4 x 16.3 x 6.2	100mm	± 1674mm
BV-ST6-3-**	1.44W	120-135lm	30 Pcs	83 x 16.3 x 6.2	120mm	± 2150mm

\*Add Colour to code: ○DL (Daylight 6500K), ●R (Red), ●G (Green), ●BL (Blue)

\*Add Number of Modules to code: /10 (10 Pcs), /30 (30 Pcs)

## PJ2 Economy Range - IP67

2 Year Warranty

Constant Voltage 12VDC | SMD 2835 | Colour Temp: 6500K | 120° View Angle



Code	Power/PC	Lumen/PC	Max Qty/Series	Dimensions (mm)	Spacing between modules	Length for 10 modules
BV-PJ2-1*	0.096W	10lm	20 Pcs	14.2 x 8.4 x 5.3	40mm	± 582mm
BV-PJ2-2*	0.192W	20lm	20 Pcs	25.2 x 8.4 x 5.3	40mm	± 692mm
BV-PJ2-3*	0.288W	30lm	20 Pcs	54.2 x 8.4 x 5.3	60mm	± 1202mm

\*Add Number of Modules to code: /10 (10 Pcs), /30 (30 Pcs)

## High Light Efficiency 3-in-1 RGB - IP67

3 Year Warranty

Constant Voltage 12VDC | Epistar 3 in 1 SMD 5050 | Synchronized colour changing driven by LED Controller | 120° View Angle



Code	Power/PC	Lumen/PC	Max Qty/Series	Dimensions (mm)	Spacing between modules	Length for 10 modules
BV-SMD-RGB*	0.72W	-	30 Pcs	70.6 x 12 x 6.8	82mm	± 1608mm

\*Add Number of Modules to code: /10 (10 Pcs), /30 (30 Pcs)

## SG2 High Output Premium Range - IP65

5 Year Warranty

Constant Voltage 12VDC | SMD 2835 | Over Moulded | Colour Temp: 6500K | 160° View Angle



Code	Power/PC	Lumen/PC	Max Qty/Series	Dimensions (mm)	Spacing between modules	Length for 10 modules
BV-SG2-144*	1.44W	230lm	20 Pcs	48 x 44.3 x 4	120mm	± 1800mm

\*Add Number of Modules to code: /10 (10 Pcs), /30 (30 Pcs)

# BACK LIT LIGHT BOX HIGH POWER LED'S

- Back Lighting
- Applied to 5-10cm deep lighting box
- 175° View angle
- Samsung LED equipped
- Constant current, Aluminium PCB

**Back Lit - 24VDC 6500K**



- 160° View angle
- Samsung LED equipped
- Constant current
- Min cutting length every 3 modules

**Back Lit - 24VDC 6500K**



Code	YD7-3.0-2403	YD7-3.0-4806	YD7-3.0-9612	Code	AL-3300-24-3
Power	3.6W	7.2W	14.4W	Power	4.8W/ 3 LED's
Lumen	357lm	708lm	1375lm	Lumen	390lm
No. of LED's	3	6	12	No. of LED's	30
Size	240 x 20mm	480 x 20mm	960 x 20mm	Length	5.250 meters

## EDGE LIT LIGHT BOX HIGH POWER LED'S

Designed for use in double sided light box 160-400mm deep  
Colour Temp: 6000K

**Non-Weather Proof - 24VDC**



**Weather Proof IP65 - 24VDC**

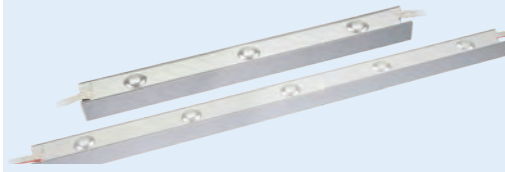

**IP65 - 12VDC**



Max 15 Modules in Series

Code	Z6003XBD-DL	Z6005XBD-DL	Z7003XBD-DL	Z7005XBD-DL	Z19-12-1
Power	6.8W	11W	6.8W	11W	3W
Lumen	660lm	1100lm	660lm	1100lm	280lm
No. of LED's	3	5	3	5	1
Size	298 x 28 x 16mm	518 x 28 x 16mm	323 x 30 x 22mm	543 x 30 x 22mm	66 x 42 x 14mm

NEW

## LED NEON FLEX

**LED Neon Soft Jacket Flex IP65** - LED Neon Flex are soft and easily bent | Ideal for indoor & outdoor signage applications

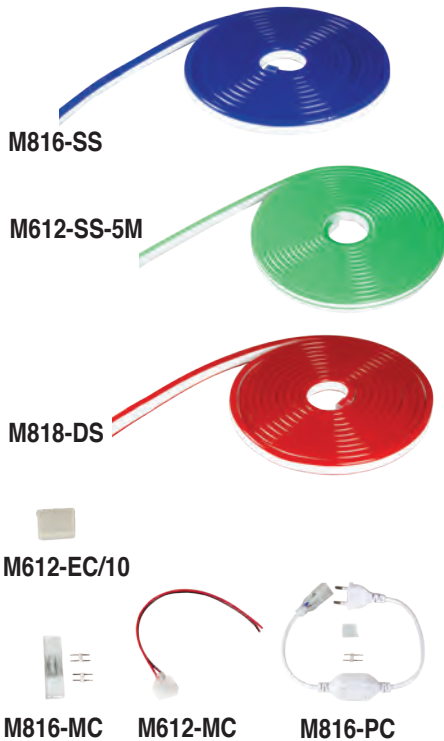

Code	Voltage	Cutting Length	No. of LEDs P/m	Max. Power	Neon Projection	Dimensions (mm)	*Add Colour to Code
M612-SS-5M*	12V	25mm	120	6W/m	Single Sided	6(W) x 12(H)	CW / WW / ● R / ● BL / ● GN / ● Y
M816-SS-*	230V	1m	120	8W/m	Single Sided	8(W) x 16(H)	
M818-DS-*	230V	1m	120	8W/m	Double Sided	8(W) x 18(H)	
M1020-SS-*	12V	50mm	120	10W/m	Single Sided	10(W) x 20(H)	● ● ● ○ RGBW

\*Add length to code: **5M** (5 Meters), **50M** (50 Meters)

\*Add colour to code: ○ WW (Warm White), ○ CW (Cool White), ● R (Red), ● GN (Green), ● BL (Blue), ● Y (Yellow)

### Accessories

Code M612	Code M816	Code M818	Code M1020	Description
M612-PC	M816-PC	M818-PC	M1020-PC	Power Connector
-	M816-MC-D	M818-MC-D	M1020-MC-D	Middle Connector
M612-MC	M816-MC	M818-MC	M1020-MC	Middle Jumper Connector
M612-EC/10	M816-EC/10	M818-EC/10	M1020-EC/10	End Cap
M612-30PVC	M816-30PVC	-	M1020-30PVC	300mm PVC Channel
M612-1ALU	M816-1ALU	-	M1020-1ALU	1m Aluminium Channel
M612-2ALU	-	-	-	2m Aluminium Channel
-	-	M818-CL/10	-	Plastic Mounting Clips

NEW

## LED NEON FLEX BLISTER PACK



**Single Side Neon Flex IP65** - Input Voltage: 230VAC | 6W per Meter | c/w Powercord | Ideal for Architectural Lighting and Fine Work

Code	Size	Lumens/m	LEDs	Length	*Colour
NL120-NEON*	8 x 16mm	1000lm/m	120 LEDs/m	5m	● ● ● ● ● ● ● ●

**Digital RGB (IC) Soft Neon Flex IP67** - Input Voltage: 230VAC | 6W per Meter | c/w Powercord, Controller & Installation Accessories | Colour Changing & Colour Effects

LR2321-IC	8 x 16mm	850lm	48 LEDs/m	5m	● ● ● (RGB IC)
-----------	----------	-------	-----------	----	----------------

**Mouldable Neon Flex IP67** - Input Voltage: 230VAC | 6W per Meter | c/w Powercord | Neon Flex can be shaped without the use of mounting clips

LR2131-S*	8 x 16mm	1000lm	120 LEDs/m	5m	● ● ● ● ● ● ● ●
-----------	----------	--------	------------	----	-----------------

\*Add colour to code: ● R (Red), ● BL (Blue), ● GN (Green), ● Y (Yellow), ● WW (Warm White) 2700K, ○ CW (Cool White) 4200K, ○ DL (Daylight) 6000K

NEW

## SILICONE LED NEON FLEX LIGHTS IP67

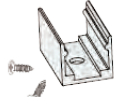
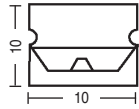
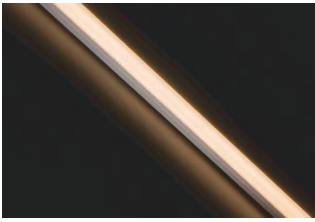

Mounting Bracket

Input Voltage: 24VDC | UV Resistant | Diffused light without visible spots | Flexible 60° and cuttable every 50mm | Dimmable with PWM Technology | Ideal for coves, walls, handrails and signage

Code	Wattage	LEDs	Dimensions	Colour Temp.
S1010A-*	9W	140lm	10 x 10 x 5000mm	CW (4000K)

\*Add colour to code:  
 ○ CW (Cool White),  
 ● WW (Warm White), ● R (Red),  
 ● BL (Blue), ● GN (Green),  
 ● Y (Yellow).

### Accessories

Code	Description
S1010-PC	1m Power Cord
S1010-MC	Middle Connector for Joining
S1010-MB	Mounting Bracket

## MINI LED NEON FLEX LIGHTS



Mini LED-Neon Flex Colour Jacket - 24H x 11W(mm)

Colour	Code	Watt/Meter	Cutting Mark
● Red	MLN-FX-*R-240V	3.9W	1.52m
● Blue	MLN-FX-50B-240V	4W	0.91m
● Green	MLN-FX-*G-240V	4W	0.91m
● Orange	MLN-FX-100-240V	3.2W	1.52m
● Yellow	MLN-FX-50Y-240V	3.2W	1.52m

### Accessories

Code	Description
MLN-FX-CA-1.6A	Power cable 1.5 metre with 1.6A converter + 2 Pin plug
MLN-FX-CA-4A	Power cable 1.5 metre with 4A converter + 2 Pin plug
MLN-FX-CA-3	Coupling with shrink tube (Joining Kit)
MLN-FX-CA-5	End Cap
MLN-FX-5	Mounting Aluminium Rail 50mm

- \*Add Length to code: 10m, 50m
- 10 meter is supplied with:
    - 1 power cord;
    - 1 x 1.6A converter 240VAC/24VDC;
    - 1 x middle joint connector;
    - 1 x end cap;
    - 5pcs aluminium mounting clips
  - 50 meters supplied as 10 meters x 5



MLN-FX-CA-1.6A



MLN-FX-CA-3



MLN-FX-5

NEW

## LED NEON FLEX LIGHTS

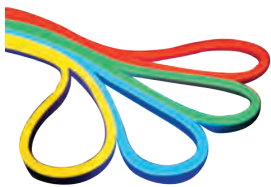

LED-Neon Flex 240VAC - Size 27.5mm (H) x 14mm (W)

LED-NEON®-FLEX is a novel and professional linear lighting device for many applications. It looks like glass neon, but is much more flexible. This product offers breakage and moisture resistance and is perfect for indoor and outdoor lighting applications. LED-NEON®-FLEX is comprised of a line of LEDs with high brightness encased in a unique PVC jacket. As a result of our proprietary optical technology, this elaborately designed jacket can greatly enhance the intensity and uniformity of the light. Due to its proprietary materials and structure, LED-NEON®-FLEX is, as the product's name suggests, flexible, durable, and virtually impregnable. It can be widely used for architectural decoration, cove lighting, embedded in a floor or ceiling, product accent, signage, P-O-P, etc...

Colour	Code	Watt/Meter	Cutting Mark	Max. length with the following converters		
				1.6A	4A	10A
○ Super Bright White 6000K	LNFX-*SB-240V	6.6	0.91m	58m	146m	362m
● Red	LNFX-*R-240V	4.7	1.52m	58m	146m	362m
● Blue	LNFX-*B-240V	6.6	0.91m	58m	146m	362m
● Green	LNFX-*G-240V	6.6	0.91m	58m	146m	362m
● Orange	LNFX-100-240V	4.7	1.52m	58m	146m	362m
● Yellow	LNFX-*Y-240V	4.7	1.52m	58m	146m	362m
● Red, ● Green, ● Blue	LNFX-*M-240V	6.6	0.91M	58m	146m	362m

- \*Add Length to code: 5m, 10m, 50m
- 5/10 meter is supplied with: 1 power cord; 1 x 1.6A converter 240VAC/24VDC; 1 x middle joint connector; 1 x end cap; 5pcs aluminium mounting clips. • 50 meters supplied as 5 & 10 meters x 5

### Accessories

Code	Description	Code	Description
FX-1.6A	Power Cable 1.5m with 1.6A converter + 2 pin plug	FX-3	Coupling with Shrink Tube (joining kit)
FX-10A	Power Cable 1.5m with 10A converter + 2 pin plug	FX-4	End cap



FX-1.6A

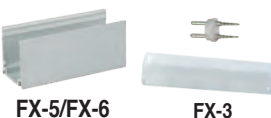

FX-5/FX-6

FX-3

COMMERCIAL

LIGHTING

**NEW** INDUSTRIAL / COMMERCIAL ZIGBEE SYSTEM



- Consumption Monitoring
- Scenes Control
- Switching Schedules
- Zigbee Device

**Zigbee Gateway** - Ethernet Interface | Ma 200 Devices max. in One Gateway | Area Setting: 20 max | Group Setting: 30 max | Bind Setting with Sensor, Switches and Remote Control | Scene and Timer Settings | 1 Admin Account + 10 Sub Accounts.

<b>Code</b>	<b>AHGW928-Z-IA</b>
Input Voltage	5VDC
Wireless Frequency	2.4GHz
Size	127.5 x 80 x 30mm



- Consumption Monitoring
- Dimmable
- Scenes Control
- Switching Schedules
- Zigbee Device

**Zigbee 1-10V Dimming LED Controller IP65** - Works with 1-10V Dimmable Driver | Zigbee Wireless Control: Smart Phone, Tablet, PC, Wall Switch, Remote Control | Works with Zigbee Gateway for Sensors, Area, Timer, Scene and Group Control | Power Metering | 3 in 1 Version: Basic / Motion Binding / Motion Daylight

<b>Code</b>	<b>AHLC734-WPC</b>
Input Voltage	100 - 277VAC
Output Voltage	1-10V / 0-10V
1-10V Current	15mA
Wireless Frequency	2.4GHz
Transmission Distance	30m
Size	195 x 50 x 50mm



**Zigbee Microwave Motion Sensors IP65** - 3 Step Dimming Control | c/w Mounting Bracket | Wall Mount or Ceiling Mount | Heat Map Sensor Option Audible

<b>Code</b>	<b>AHMS823-Z*</b>
Input Voltage	100 - 277VAC
Wireless Frequency	2.4GHz
Detection Range	Ø30m @ 15m
Mounting Height	15m Max
Detection Angle	30° - 150°
Size	Ø55.2 x 24.5 (Without Bracket)

\* Add to Code: **CMS** (Ceiling Mounted Sensor), **WMS** (Wall Mount Sensor)

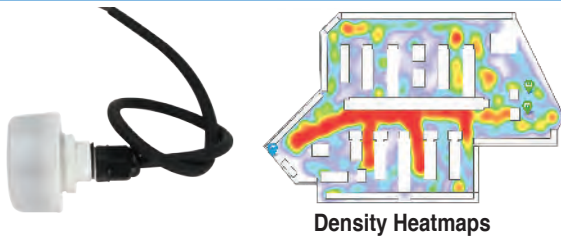

Density Heatmaps

**Zigbee Heatmap Sensor IP65** - 3 Step Dimming Control | c/w Mounting Bracket

<b>Code</b>	<b>AHMS823-Z-HM</b>
Input Voltage	100-277VAC
Wireless Frequency	2.4GHz
Detection Range	0-65528lux
Resolution	10lux
Size	55.2 x 24.5 (Without Bracket)



**Zigbee Daylight Sensor IP65** - Automatic Illuminance Control on Indoor Lighting Based on Ambient Light | Set Constant Illuminance Value on App

<b>Code</b>	<b>AHDS826-Z-DS</b>
Input Voltage	100-277VAC
Wireless Frequency	2.4GHz
Detection Range	0-65528lux
Resolution	10lux
Size	55.2 x 24.5 (Without Bracket)



- Consumption Monitoring
- Dimmable
- Scenes Control
- Zigbee Device

**Zigbee Multi-functional Wall Switch** - used to manually control lights

<b>Code</b>	<b>AHWS-933-Z-MWS</b>
Input Voltage	200-240VAC
Output	3A - relay output
Wireless frequency	2.4GHz
Transmission distance	30m
Size	86 x 86 x 35mm



The PC software/ mobile App works with smart lighting system for Area control, Group settings, Scene control, Schedule control, Account management, Lamp power metering function, Lamps fail report function, OTA function and all devices that follow Zigbee HA1.2 protocol through WiFi - Zigbee Gateway

• Linux/Windows PC software by special request (with a price)

**AH-SERVER-I**



## DMX CONTROLLERS



Code	DMX-512-12V	SRC-174	SRC-144
Description	<ul style="list-style-type: none"> <li>• 5 Channels, each channel 8A, 480W@12V, 960W@24V.</li> <li>• RJ45, 5 Pin XLR or 3 Pin XLR screen terminal selectable.</li> <li>• 1ch to 5 ch selectable</li> <li>• PWM Output resolution ratio 8 bits, 16 bits selectable.</li> <li>• PWM Frequency selectable from 500Hz - 9KHz.</li> <li>• Dimming curve gamma value selectable from 0.1 - 9.9</li> </ul>	<ul style="list-style-type: none"> <li>• Allows you to program 12 scanners with 16DMX channels each,</li> <li>• 30 banks of 8 programmable scenes, 6 chases of 240 scenes using 8 channel sliders, a joystick, and other buttons.</li> <li>• With the ease of the joystick, you can accurately control the movement of a fixture.</li> <li>• In addition, two units can set up communication so that they can send or receive a complete file dump.</li> <li>• Fog machine output and activation button.</li> </ul>	<ul style="list-style-type: none"> <li>• 230VAC 52 Channel DMX Controller</li> <li>• Easy-to-use DMX controller for programming up to 9 intelligent lights</li> <li>• 52 Channels with 9 projector banks of 4 channels each</li> <li>• Scene, program and projector LED displays</li> <li>• 9 programs with up to 50 steps per program</li> <li>• Fade and Speed Control</li> <li>• Built-in microphone for sound-active mode</li> <li>• DC 9V power supply included</li> </ul>

## DMX DECODERS

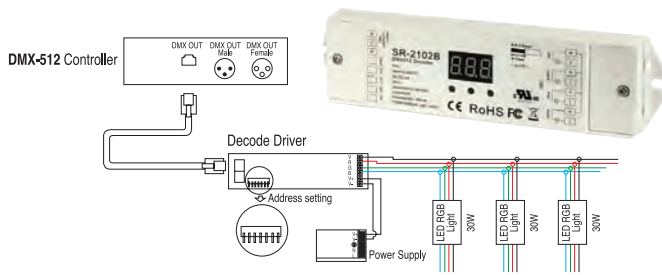

### DMX 512 Decoder

Code	IMG-DV512
Input Voltage	12-36VDC
Load Current	4ch, 5A
Load Power	240W@12V, 480W@24V, 720W@36V
Output Signal	PWM
Decoding Signal	DMX512
RGB Changes	1
Size (mm)	130 x 40 x 35

## BOX TYPE SWITCH MODE POWER SUPPLIES

### Chassis Mount Supply Volts: 170 - 260VAC

- Output Accuracy:  $\pm 2\%$
- Load Regulation:  $\pm 2\%$
- Overload Protection
- Short Circuit Protection

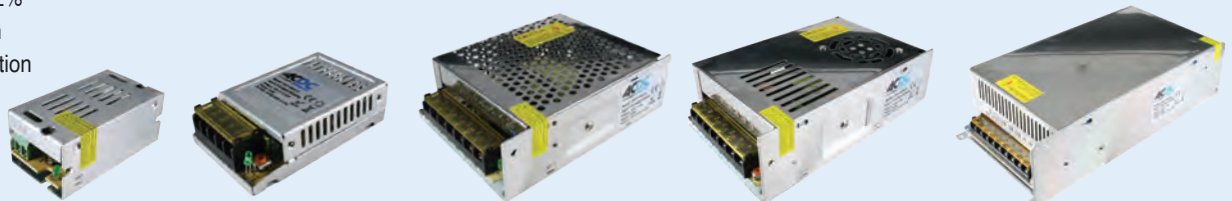

### BC1

15W

25W

40-200W

250W-350W

480W

Watts	Code 5VDC	Amps	Code 12VDC	Amps	Code 24VDC	Amps	Code 48VDC	Amps	Size (mm) W x L x H
15W	SNP-15W/5	3A	SNP-15W/12	1.3A	—	—	—	—	70 x 39 x 31
25W	SNP-25W/5	5A	SNP-25W/12	1.7A	SNP-25W/24	1.1A	—	—	80 x 48 x 22
40W	—	—	SNP-40W/12	3.5A	SNP-40W/24	1.8A	—	—	110 x 79 x 35
60W	SNP-60W/5	10A	SNP-60W/12	5A	SNP-60W/24	2.5A	SNP-60W/48	1.25A	110 x 79 x 35
100W	SNP-100W/5	20A	SNP-100W/12	8.5A	SNP-100W/24	4.5A	—	—	129 x 98 x 38
120W	—	—	SNP-120W/12	10A	SNP-120W/24	5A	SNP-120W/48	2.5A	129 x 98 x 38
150W	—	—	SNP-150W/12	12.5A	SNP-150W/24	6.2A	—	—	160 x 98 x 50
200W	—	—	SNP-200W/12	16.5A	SNP-200W/24	8.3A	SNP-200W/48	4.2A	160 x 98 x 50
250W	—	—	SNP-250W/12	20A	SNP-250W/24	10A	SNP-250W/48	5A	160 x 98 x 50
350W	—	—	SNP-350W/12	30A	SNP-350W/24	15A	SNP-350W/48	7.5A	199 x 98 x 50
480W	—	—	—	—	SNP-480W/24	20A	—	—	240 x 125 x 65



## MEANWELL POWER SUPPLIES & DRIVERS

Code	Output			Input	Size (mm)
	Power	DC Voltage	Current	Voltage	

### Power Supplies - LRS Series IP30

LRS-35-12	35W	12V	3A	AC85-264V	99 x 82 x 30
LRS-35-24		24V	1.5A		
LRS-50-12	50W	12V	4.2A	AC85-264V	99 x 82 x 30
LRS-50-24		24V	2.2A		
LRS-75-12	75W	12V	6A	AC85-264V	99 x 97 x 30
LRS-75-24		24V	3.2A		
LRS-100-12	100W	12V	8.5A	AC85-264V	129 x 97 x 30
LRS-100-24		24V	4.5A		
LRS-150-12	150W	12V	12.5A	85-132VAC/ 170-264VAC	159 x 97 x 30
LRS-150-24		24V	6.5A		
LRS-200-12	200W	12V	17A	AC180-264V	215 x 115 x 30
LRS-200-24		24V	8.8A		
LRS-350-12	350W	12V	29A	AC180-264V	215 x 115 x 30
LRS-350-24		24V	14.6A		

**3 Year  
Warranty!**



- Can be used in Class 1, Division 2 hazardous luminaires
- 1 - 10V or PWM Signal or resistance dimming
- Output Volts: 30 - 40V
- Output Volts Regulation: 0.5%

**5 Year  
Warranty!**



### Power Supplies - HLG Series - Built-in Active PFC Function IP67

HLG-40H-36A	40W	36V	1.12A	AC90-305V	171 x 61.5 x 368
HLG-60H-36A	60W	36V	1.7A	AC90-305V	171 x 61.5 x 368
HLG-80H-36A	80W	36V	2.3A	AC90-305V	195 x 61.5 x 368
HLG-100H-36A	100W	36V	2.65A	AC90-305V	220 x 68 x 38.8
HLG-120H-36A	120W	36V	3.4A	AC90-305V	220 x 68 x 38.8
HLG-150H-36A	150W	36V	4.2A	AC90-305V	228 x 68 x 38.8
HLG-185H-36A	185W	36V	5.2A	AC90-305V	228 x 68 x 38.8
HLG-240H-36A	240W	36V	6.7A	AC90-305V	244.2 x 68 x 38.8
HLG-320H-36A	320W	36V	8.9A	AC90-305V	252 x 90 x 43.8

**2 Year  
Warranty!**



### Power Supplies - APV Series IP30

APV-12-12	12W	12V	1A	AC90-264V	77 x 40 x 29
APV-12-24		24V	0.5A		
APV-16-12	16W	12V	1.25A	AC90-264V	77 x 40 x 29
APV-16-24		24V	0.67A		
APV-25-12	25W	12V	2.1A	AC90-264V	84 x 57 x 295
APV-25-24		24V	1.05A		
APV-35-12	35W	12V	3A	AC90-264V	84 x 57 x 295
APV-35-24		24V	1.5A		

**2 Year  
Warranty!**



### Power Supplies - LPV Series IP67

LPV-20-12	20W	12V	1.67A	AC90-264V	118 x 35 x 26
LPV-20-24		24V	0.84A		
LPV-35-24	35W	24V	1.5A	AC90-264V	148 x 40 x 30
LPV-60-12	60W	12V	5A	AC90-264V	162.5 x 42.5 x 32
LPV-60-24		24V	2.5A		
LPV-100-12	100W	12V	8.5A	AC90-264V	190 x 52 x 37
LPV-100-24		24V	4.2A		
LPV-150-12	150W	12V	10A	AC180-305V	191 x 63 x 37.5
LPV-150-24		24V	6.3A		

2 Year warranty on all LED products, unless otherwise specified. Warranty void if adequate surge protection is not installed on LED products. See page 147

## LED CONSTANT VOLTAGE DRIVERS - VS

NEW

**VS LIGHTING SOLUTIONS**



**Easyline - 12V - IP20** | Electronic short circuit protection | Overload protection | Protection against "No-Load" operation | Protection class II

Code	Watts	Current (A)	Output Volts	Dimensions (mm)
186621	60W	5	12V	180 x 45 x 19
186623	100W	8.40	12V	300 x 40 x 30

**Comfort Line - 24V - IP20** | Electronic short circuit protection | Overload protection | Protection against "No-Load" operation | Protection class II

Code	Watts	Current (A)	Output Volts	Dimensions (mm)
186625	60W	2.5	24V	153 x 41 x 32
186627	120W	5	24V	300 x 40 x 30

**Easyline - 12V - IP67** | Electronic short circuit protection | Overload protection | Protection against "No-Load" operation | Protection class II

Code	Watts	Current (A)	Output Volts	Dimensions (mm)
186629	75W	6.25	12V	155 x 50 x 32
186630	100W	8.34	12V	206 x 69 x 37
186631	150W	12.5	12V	206 x 69 x 37

**Comfort Line - 24V - IP67** | Electronic short circuit protection | Overload protection | Protection against "No-Load" operation | Protection class II

Code	Watts	Current (A)	Output Volts	Dimensions (mm)
186432	75W	3.125	24V	180 x 42 x 34
186433	100W	4.2	24V	206 x 68 x 37
186434	150W	6.25	24V	206 x 68 x 37

## LED DRIVERS

**IP68** - Supply Volts 170 - 250VAC | Short Circuit protection | Overload protection



PSU-2.5/12

Code	Watts	Current (A)	Output Volts	Dimensions (mm)
PSU-1.5/12	20W	1.5	12VDC	162 x 27 x 21
PSU-2.5/12	30W	2.5	12VDC	177 x 31 x 21
PSU-5/12	60W	5	12VDC	133 x 62 x 38
PSU-8.3/12	100W	8.3	12VDC	205 x 132 x 65
PSU-12.5/12	150W	12.5	12VDC	205 x 117 x 58

**LED Drivers - Constant Voltage**



APT-MR16-12V

APT-AR111-15V

LHV100W24

Code	Volts In	Volts Out	Current Out	Power	Size (mm)	For use with
APT-MR16-12V	90-264VAC	12VDC	500mA	6W	51 x 42 x 23	-
APT-AR111-15V	90-264VAC	15VDC	800mA	12W	60 x 20 x 32	LEDAR111
LHV100W24	220-240VAC	24VDC	4.2A	100W	180 x 88 x 36	-

## LED DIMMABLE DRIVER IP65

Constant Voltage



Code	LEA-103C	LEA-105A	LEA-108A	LEA-112-A	LEA-115A
Input Voltage	100-277VAC				
Constant Voltage	12VDC				
Output Power	36W	60W	96W	150W	200W
Protection	Short Circuit, Overload, Over Heat				
External Dimming Control	0-100% (1-10V)				
Size (mm)	260 x 29 x 20	178 x 68 x 53	240 x 68 x 53	256 x 80 x 53	256 x 80 x 53

COMMERCIAL

LIGHTING

## LED FLOOR & WALL LIGHTS



Supply Voltage: 230VAC	3 light kit 	3 light kit 	3 light kit 
Kits c/w 230VAC Transformer and 3-in-1 connector			
<b>Code</b>	<b>CIE-L001-*</b>	<b>CIE-L002-*</b>	<b>LED-HH03/3-*</b>
Size (mm)	95 x 95 x 125	Ø95 x 125	Ø59 x 50
LED's/Light	4 x 0.15W (0.6W)	6 x 0.1W (0.6W)	5 x 0.1W (0.5W)
<b>IP Rating</b>	<b>IP44</b>	<b>IP44</b>	<b>IP65</b>
Lumen/Lamp	13	13	9
Material	Stainless Steel	Stainless Steel	Aluminium

\*Add colour to code: ○ CW (Cool White), ○ WW (Warm White), ● BL (Blue), ● Y (Yellow), ● GN (Green), ● R (Red)

Supply Voltage: 230VAC	3 light kit 	5 light kit (35mm Ø cutout) For 5 light kit 10VA Transformer 	3 light kit 
Kits c/w 230VAC Transformer and 3-in-1 connector			
<b>Code</b>	<b>HLF01702-*</b>	<b>LED-P03C/5-*</b> Kit	<b>HLG01201-*</b> Single light
Size (mm)	Ø30 x 15	Ø40 x 57	73 x 73 x 18
LED's/Light	1W	6 x 0.08W (0.5W)	12 x 0.04W (0.5W)
<b>IP Rating</b>	<b>IP20</b>	<b>IP65</b>	<b>IP20</b>
Lumen/Lamp	138	15	38
Material	Plastic / Clear PC	Aluminium / Clear Glass	Nickel / Matt Glass

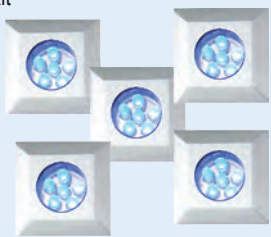

\*Add colour to code: ○ CW (Cool White), ○ WW (Warm White), ● BL (Blue), ● Y (Yellow), ● GN (Green), ● R (Red)

\*CW, WW & BL available

Supply Voltage: 230VAC	5 light kit 	3 light kit 	3 light kit 
Kits c/w 230VAC Transformer and 3-in-1 connector			
<b>Code</b>	<b>HLG01402-*</b>	<b>HLG01604-*</b>	<b>HLG02102-*</b>
Size (mm)	40 x 40 x 44	59 x 59 x 50	Ø55 x 8
LED's/Light	6 x 0.08W (0.5W)	5 x 0.1W (0.5W)	3 x 0.5W (1.5W)
<b>IP Rating</b>	<b>IP65</b>	<b>IP65</b>	<b>IP65</b>
Lumen/Lamp	15	9	46
Material	Aluminium	Aluminium	Aluminium

\*Add colour to code: ○ CW (Cool White), ○ WW (Warm White), ● BL (Blue), ● Y (Yellow), ● GN (Green), ● R (Red)

### Accessories

	<b>Outdoor Transformers IP68</b> 				
<b>Code</b>	<b>3-IN-1</b>	<b>6-IN-1</b>	<b>TRF24/6</b>	<b>TRF24/20</b>	<b>TRF24/30</b>
Description	Spare 3 in 1 connector for kits	Spare 6 in 1 connector for kits	230V/24VAC 6VA	230V/24VAC 20VA	230V/24VAC 30VA

# LED DECK LIGHTS

**NEW**

 Supply Volts: **IP67** Single Light  
 12VDC  
 Low Profile:  
 9mm

**IP67**

 6 Pcs Kit  
 comes with T-Cable,  
 Power Supply,  
 Controller (RGB)

Code	SC-B101B-*	SC-B101C	SC-B102B-*	SC-B102C	SC-6B101B-CW	SC-6B101C-RGB	SC-6B102B-CW	SC-6B102C-RGB
Power	0.5W	0.7W	0.6W	0.9W	0.5W	0.7W	0.6W	0.9W
No. of LEDs	1pc				6pcs Kit			
LED Colour	Single	RGB	Single	RGB	Cool White	RGB	Cool White	RGB
Cut-Out (mm)	Ø51mm		51 x 51mm		Ø51mm		51 X 51mm	
Size (mm)	Ø58 x 9		58 x 58 x 9		Ø58 x 9		58 X 58 X 9	
Material	304 Stainless Steel				304 Stainless Steel			
Connection	1m Cable with male plug				1m Cable with male plug			

\*Add colour to code: ● R (Red), ● BL (Blue), ● Y (Yellow), ● GN (Green), ○ CW (Cool White), ○ WW (Warm White)

Code	SC-B103B-*	SC-B104B-*	SC-B104C	SC-B105B-*	SC-B106B-*
Power	0.4W	0.4W		0.3W	0.23W
No. of LEDs	1pcs	1pcs		1pcs	1pcs
LED Colour	Single	Single	RGB	Single	Single
Cut-Out (mm)	Ø51mm	Ø33mm		Ø24mm	Ø24mm
Size (mm)	Ø58 x 9	Ø40 x 19		Ø30 x 19	Ø35 x 31
Material	304 Stainless steel	304 Stainless steel		304 Stainless steel	Die Cast Aluminium
Connection	1m cable with Male plug	2 x 1m cable with Male plug & Female plug		2 x 1m cable with Male plug & Female plug	1m cable with Female plug

\*Add colour to code: ● R (Red), ● BL (Blue), ● Y (Yellow), ● GN (Green), ○ CW (Cool White 6500K), ○ WW (Warm White)

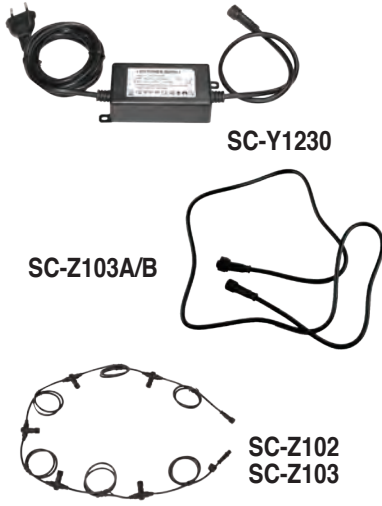
**Connectors & Accessories**

Code 2 Wire (Single Colour)	Code 4 Wire (Colour Changing)	Description
SC-Z103A-3M	SC-Z103B-3M	3m Cable with male & female Connectors
SC-Z102	SC-Z103	5pcs "T" Connection Cable - 0.5m between pieces
SC-Z105A	SC-Z105B	Waterproof "T" Connector
SC-Z106A	SC-Z106B	Waterproof Connection Box
	SC-Y1230	12VDC power supply for use with Deck lights 0.3m cable with female plug. Supply voltage: 90-264VAC Max loading: 30W (2.5A) 12VDC
-	SC-Z101	RGB controller for use with deck lights with 0.5m input and output cables <b>IP67</b>



# SOLAR IN-GROUND LIGHTS

**SOLAR**

Batteries Included

**SOL2**
**Stainless Steel In-ground Series IP44**
**In-ground IP68**
**Paving Lamp IP44**

Code	RW2LED-120	RW3LED-120	SDDM002	SDDM002-2	ZH-03-W	RW-SLR001
Size (mm)	Ø120 x 35D	Ø120 x 35D	125 x 125	125 x 125	Ø50 x 35	Ø120 x 35D
Type	2 x White LED	3 x White LED	4 x White LED	RGB colour changing	1 x White LED	1 x LED
Batteries	1 x NiMh 600mA	2 x NiMh 600mA	1 x NiMh 600mAh	1 x NiMh 600mAh	1 x NiMh 350mAh	1 x NiMh 600mA

## EMPTY INGROUND LIGHTS - IP67

Lamps excluded | Stainless Steel

<b>Code</b>	<b>MXD-100-1</b>	<b>MXD-100-3</b>	<b>MXD-100-6</b>	<b>MXD-120-1F</b>
Lamp Holder	MR16	MR16	MR16	MR16
Size	Ø100 x 120	Ø100 x 120	Ø100 x 120	Ø120 x 130
Hole Size (mm)	Ø90 x 120	Ø90 x 120	Ø90 x 120	Ø98 x 130
<b>Code</b>	<b>NB1033-D</b>	<b>NB1033-A</b>	<b>NB1033-C</b>	
Lamp Holder	MR16	GU10	E27	
Size	Ø100 x 156	98 x 98 x 147	Ø154 x 255	
Hole Size (mm)	Ø90 x 156	Ø88 x 147	Ø144 x 255	

## LED INGROUND LIGHTS IP66



Supply Voltage: 230VAC | Material: Stainless Steel

	Fixed	Fixed	Tiltable	
<b>Code</b>	<b>NCC-180C-*</b>	<b>NCC-260C-*</b>	<b>NCC-250-3-*</b>	
LED	10W	30W	9W	
Lumens	1000lm	3000lm	900lm	
Size (mm)	Ø180 x 115	Ø260 x 120	Ø250 x 210	
Hole Size (mm)	Ø170 x 120	Ø240 x 120	Ø240 x 150	
	Tiltable	Fixed	Fixed	Tiltable
<b>Code</b>	<b>XGN-T260-*</b>	<b>MXD-100-7-*</b>	<b>MXD-100-8-*</b>	<b>XGN-C210-*</b>
LED	18W	3W	3W	7W
Lumens	1800lm	300lm	300lm	700lm
Size (mm)	Ø260 x 325	Ø100 x 75	Ø100 x 75	Ø210 x 270
Hole Size (mm)	Ø248 x 335	Ø90 x 75	Ø90 x 75	Ø195 x 280
	12VAC/DC			
<b>Code</b>	<b>MXD-100-7*-12VDC</b>	<b>LED-3739/4-*</b>	<b>WL11009A-*</b>	
LED	3 x 1W (3W)	28 X 0.1W (2.3W)	12 x 0.08W (1W)	
Lumens	90lm	84lm	10lm	
Size (mm)	Ø90 x 45	Ø145 x 130	100Ø x 80D	
Hole Size (mm)	Ø80 x 45	Ø135 x 130	Ø90 x 80	









Add colour to code: \*○ CW (Cool White), ○ WW (Warm White)  
 \*○ WH (White), ● BL (Blue), ● Y (Yellow), ● GN (Green), ● R (Red)  
 \*○ CW (Cool White), ○ WW (Warm White), ● R (Red), ● GN (Green), ● BL (Blue), ● Y (Yellow)  
 \*○ CW (Cool White), ● BL (Blue)

2 Year warranty on all LED products, unless otherwise specified. Warranty void if adequate surge protection is not installed on LED products. See page 147

**GARDEN SPOT LIGHTS**

<b>Spot Lights</b> Lamps excluded	 Ø97 x H155mm		 Ø63 x H157 x D77mm
<b>Code</b>	<b>NB1036</b>	<b>NB1057-D</b>	<b>C7033-ST</b>
Lamp	Max. 50W 12V MR16	Max. 75W PAR38 (ACL91)	MR16 35W 12V
Lamp Holder	MR16	E27	GU 5.3
<b>IP Rating</b>	<b>IP65</b>	<b>IP65</b>	<b>IP54</b>
Material	Die Cast Aluminium body	Stainless Steel	Stainless Steel

**EMPTY GARDEN SPIKE LIGHTS**

Lamps excluded	 <b>IP65</b>	 <b>IP65</b>	 <b>IP65</b>	 <b>IP65</b>	 <b>IP65</b>
<b>Code</b>	<b>NB1038</b>	<b>NB1036-B</b>	<b>NB1037</b>	<b>NB1051</b>	<b>NB1052</b>
Lamp	Max. 50W 12V MR16	Max. 50W 12V MR16	Max. 50W 12V MR16	Max. 50W 12V MR16	Max. 50W 12V MR16
Lamp Holder	MR16	MR16	MR16	MR16	MR16
Material	Die Cast Aluminium body	Die Cast Aluminium body	Die Cast Aluminium body	Die Cast Aluminium body	Die Cast Aluminium body
	 <b>IP44</b>	 <b>IP44</b>	 <b>IP44</b>	 <b>IP65</b>	
<b>Code</b>	<b>NB1070</b>	<b>NB1074</b>	<b>EL200660</b>	<b>C800-504</b>	
Lamp	Max. 80W	<b>PL-13-CW</b>	Max. 120W	3 x MR16 20W	
Lamp Holder	E27	G23	2 x E27	GU4/GZ4	
Material	ABS Plastic	ABS Plastic	Thermo Plastic	Die-cast Aluminium	

**GARDEN SPIKE LIGHTS**

Supply Voltage: 230VAC	 <b>IP65</b> <b>LED</b> Optional lenses: ● RW-LED-4-LENS-BL ● RW-LED-4-LENS-R ● RW-LED-4-LENS-G	 <b>IP65</b> c/w 12V transformer <b>LED</b>	 <b>IP68</b> <b>LED</b>	 <b>IP20</b> S.Steel + Glass Trim <b>LED</b>	 Plastic Spot Lamp <b>SOLAR</b> <b>IP67</b> Battery: 1 x NiMh 600mA
<b>Code</b>	<b>RW-LED-4-CW</b>	<b>RW-LED-18*</b>	<b>LED-9030*</b>	<b>LED-3031AS*</b>	<b>RW-SLP006</b>
LED's	4W	3 x 6W	3 x 1 (3W)	3 x 1W (3W)	1 x LED
Lumen	220lm	280lm x 3	270lm	90lm	150lm
Size (mm)	Ø72 x 257	Ø72 x 257	Ø98 x 320	Ø65 x 350	160 x 85 x 330

\*Add colour to code: ○ CW (Cool White), ● BL (Blue), ● R (Red), ● G (Green), ● Y (Yellow)

OUTDOOR

LIGHTING

**LIT**

2 Year warranty on all LED products, unless otherwise specified. Warranty void if adequate surge protection is not installed on LED products. See page 147

**SOLAR GARDEN LIGHTS IP44**
**SOLAR**

- Batteries Included
- Height does not include spike

**SOL2**

Code	RW-SF-03-8	RW-SF-03-2	RW-SF-02-1	RW-SF-03-4	RW-SLS004	E2009	CON-SOLAR
Size (mm)	320H x 115Ø	455H x 120Ø	605H x 138Ø	325H x 125Ø	360 x 115Ø	390H x 130Ø	1 Litre Consol Jar
Type	1 x LED	1 x LED	1 x LED	1 x LED	1 x LED	1 x LED	4 x LED
Batteries:	1 x NiMh 600mAh	1 x NiMh 600mAh	1 x NiMh 600mAh	1 x NiMh 600mAh	1 x NiMh 600mAh	1 x NiMh 600mAh	2x1.2V 600mAh AAA
Material	Plastic	Plastic	Plastic	Plastic	Stainless Steel	Stainless Steel	Glass

**SOLAR**

- Batteries Included
- Height does not include spike

**SOL2**

Code	RW-SLS001	RW-SLS002	RW-SLS003	SDBX115	S-1718	ESL-10	SL-04M
Size (mm)	307.5H x 150Ø	480H x 170Ø	365H x 125Ø	420H x 170Ø	570 x 115 x 90	800mm (H)	510(H) x 110Ø
Type	1 x LED	1 x LED	1 x LED	1 x LED	15 LEDs (200lm)	1 x LED	1 x LED
Batteries:	1 x NiMh 600mAh	1 x NiMh 600mAh	1 x NiMh 600mAh	1 x NiMh 600mAh	1x3.7V 1800mAh 18650	Li-ion Battery	Li-ion Battery 450mAh
Material	Stainless Steel	Stainless Steel	Stainless Steel	Stainless Steel	PC + ABS	PC & Aluminium	Stainless Steel

**DECORATIVE GARDEN SPIKE LIGHTS IP44**

Supply Voltage: 230VAC | c/w 230/12V Transformer

c/w 230/12V Transformer &amp; 3-in-1 connector

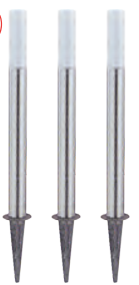
**LED**

**LED**

**LED**

Code	KH833S-*	KH834S-*	KH833-*	KH105	KH342
Lamp	2 x 0.12W (0.24W)	3 x 0.12W (0.36W)	3 x 0.72W (0.24W)	G6.35 (G4) / 10W	G6.35 (G4) / 10W
Lumen	6lm	9lm	9lm	55lm	55lm
Size (mm)	Ø25 x 294	Ø51 x 315	Ø38 x 260	Ø90 x 312	Ø38 x 300

\* Add colour to code: ○CW (Cool White), ●BL (Blue)

**LED**

**LED**

**LED**

**Flame Effect Torch Spike**
**IP65**  
 Battery:  
 1 x LiPO  
 2000mA

**NEW**







**SOLAR**

Code	KH810-*	KH825-*	CIE-L003	BF-SGL1-W
LEDs	9 x 0.12W (1.08W)	9 x 0.12W (1.08W)	2 x 6 x 0.06W	Flame Effect LED 1W
Lumen	27lm	27lm	36lm	150lm
Size (mm)	Ø60 x 260 x 100	Ø60 x 110	Ø200 x 450	Ø137 x 1000

\* Add colour to code: ○CW (Cool White), ●BL (Blue)

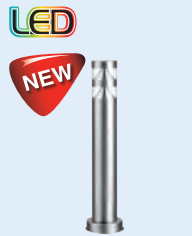
**LIT**

**STAINLESS STEEL BOLLARDS**

Supply Voltage: 230VAC						
* Add Colour to code						
<b>Code</b>	<b>TL-ST-06E</b>	<b>TL-ST-06D</b>	<b>TL-ST-06C</b>	<b>KH836-SS</b>	<b>KH834-PSH</b>	<b>CIE-L006-300-*</b>
<b>LEDs</b>	2 x 6W	2 x 6W	2 x 6W	24 x 0.12W (2.88W)	16 x 0.12W (1.92W)	16 x 0.12W (1.92W)
<b>Lumen</b>	550lm	550lm	550lm	66lm	48lm	550lm
<b>IP Rating</b>	<b>IP44</b>	<b>IP44</b>	<b>IP44</b>	<b>IP44</b>	<b>IP44</b>	<b>IP44</b>
<b>Size (mm)</b>	Ø76 x 870	Ø76 x 675	Ø76 x 520	Ø76 x 300	Ø80 x 400	Ø76 x 520
<b>Colour Temp</b>	4200K	4200K	4200K	4200K	4200K	*CW / ●R / ●GN / ●BL / ●Y

Supply Voltage: 230VAC Order Lamps separately						
--	---	---	--	---	---	---

<b>Code</b>	<b>C300-224-650</b>	<b>C300-224</b>	<b>YF-B5207</b>	<b>CIE007-1-1050</b>	<b>CIE007-2H</b>	<b>C300-216</b>
<b>Lamp</b>	60W Max	60W Max	60W Max	60W Max	2x60W Max	40W Max
<b>Lamp Holder</b>	E27	E27	E27	E27	E27	E27
<b>IP Rating</b>	<b>IP44</b>	<b>IP44</b>	<b>IP44</b>	<b>IP44</b>	<b>IP44</b>	<b>IP44</b>
<b>Size (mm)</b>	Ø200 x 650	Ø250 x 1175	Ø250 x 800	Ø200 x 1050	Ø200 x 1180	Ø120 x 800

Supply Voltage: 230VAC Material: PP Plastic & Stainless Steel Order Lamps separately						
--	---	---	---	--	---	---

<b>Code</b>	<b>CIE007-500</b>	<b>CIE007-1-500</b>	<b>CIE016-600</b>	<b>CIE014S-450</b>	<b>CIE014-450</b>
<b>Lamp</b>	100W Max	100W Max	60W Max	60W Max	60W Max
<b>Lamp Holder</b>	E27	E27	E27	E27	E27
<b>IP Rating</b>	<b>IP44</b>	<b>IP44</b>	<b>IP44</b>	<b>IP44</b>	<b>IP44</b>
<b>Size (mm)</b>	Ø200 x 380	Ø200 x 380	Ø76 x 600	Ø76 x 450	Ø75 x 450

**DIE-CAST ALUMINIUM BOLLARDS**

Supply Voltage: 230VAC Die Cast Aluminium Colour: Dark Grey Temp.: 4000K				
---	---	---	---	--

<b>Code</b>	<b>YSC-1007</b>	<b>YSC-1004</b>	<b>YSC-1000</b>	<b>YSC-1002</b>
<b>Wattage</b>	5W	5W	5W	5W
<b>Lumens</b>	500lm	500lm	500lm	500lm
<b>IP Rating</b>	<b>IP54</b>	<b>IP54</b>	<b>IP54</b>	<b>IP54</b>
<b>Size (mm)</b>	76 x 76 x 800	50 x 120 x 800	60 x 102 x 800	100 x 160 x 850

OUTDOOR

LIGHTING



## EMPTY BOLLARDS

Supply Voltage:  
230VAC  
Die-cast  
Aluminium  
Bodies  
Lamps excluded  
**IP44**

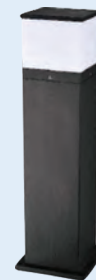

Code	YSC-3011	YSC-3030	YSC-3039	YSC-3048	YSC-3024
Lamp Base	E27 (18W Max.)	E27 (18W Max.)	E27 (18W Max.)	E27 (18W Max.)	E27 (18W Max.)
IP Rating	<b>IP44</b>	<b>IP44</b>	<b>IP44</b>	<b>IP44</b>	<b>IP44</b>
Size (mm)	158 x 800	200 x 100 x 700	Ø160 x 800	Ø160 x 740	160 x 700

Supply Voltage:  
230VAC  
Die-cast  
Aluminium  
Bodies  
Lamps excluded



Code	YSC-3028	YSC-3078	YSC-3085	NB3077
Lamp Base	E27 (18W Max.)	E27 (18W Max.)	E27 (18W Max.)	E27 (100W Max.)
IP Rating	<b>IP44</b>	<b>IP44</b>	<b>IP44</b>	<b>IP44</b>
Size (mm)	160 x 750	Ø280 x 600	Ø220 x 600	Ø205 x 650

Supply Voltage:  
230VAC  
Die-cast  
Aluminium  
Bodies  
Lamps excluded



Code	NB3078	NY21836R	NY11836R*
Lamp Base	E27	2 x E27/75W	E27/75W
IP Rating	<b>IP44</b>	<b>IP54</b>	<b>IP54</b>
Size (mm)	Ø170 x 650	260 x 990	124 x 990

Add - SC to code for smokey clear lense

## SOLAR BOLLARDS & POST TOPS

### SOLAR

- 6-8 Hours Normal Brightness
- Aluminium Body & Glass Lamp Shade
- Auto Turn On / Off Dusk & Dawn

### SOL2

#### Solar Bollards IP44

#### Solar Post Tops IP44



Code	JY-0012-C	JY-0007-C	JY-0008-C	JY-0012-D	JY-0007-D	JY-0008-D
Wattage	2.4W	3W	4W	2.4W	3W	4W
Lumens	130lm	220lm	220lm	130lm	220lm	220lm
Size	Ø220 x 1400	Ø260 x 1300	Ø280 x 1300	Ø220 x 1800	Ø260 x 1750	Ø280 x 1750

2 Year warranty on all LED products, unless otherwise specified. Warranty void if adequate surge protection is not installed on LED products. See page 147

LIT

© ACDC Dynamics

OUTDOOR

LIGHTING

**POST TOPS**

Supply  
Voltage:  
230VAC  
Lamps  
Excluded  
Pole Included  
Material: Steel

						
<b>Code</b>	<b>LH-5004G</b>	<b>LH-5004G-2.4M</b>	<b>LH-5004-3G</b>	<b>LH-5029G</b>	<b>LH-5029-2G</b>	<b>LH-5029-3G</b>
Lamp	E27/100W	E27/100W	3 x E27/100W	E27/60W	2 x E27/60W	3 x E27/60W
<b>IP Rating</b>	<b>IP44</b>	<b>IP44</b>	<b>IP44</b>	<b>IP54</b>	<b>IP54</b>	<b>IP54</b>
Size (mm)	1200(H)	2400(H)	2280(H)	2360(H)	2360(H)	2360(H)

**POST TOP HEADS IP55**

Input Voltage:  
220 - 240VAC

				
<b>LED</b>	<b>LED</b>	<b>LED</b>	<b>LED</b>	<b>LED</b>
Colour Temp: 6000K	Colour Temp: 6000K	Colour Temp: 6000K	Colour Temp: 4200K	Colour Temp: 4200K

<b>Code</b>	<b>01-006-LED</b>	<b>RW-GL-LED-30W</b>	<b>RW-GL-LED-50W</b>	<b>AG-008</b>	<b>K-ST-60-P</b>
Max Power	40W	30W	50W	50W	60W
Lumens	4000lm	3000lm	5000lm	5400lm	6000lm
Size (mm)	Ø700 X 460	Ø160 x 600	Ø485 x 695	Ø500 x 660	Ø600 x 160
Material	Die Cast Aluminium	Die Cast Aluminium	Die Cast Aluminium	Die Cast Aluminium	Die Cast Aluminium
Entry	Ø76	Ø76	Ø76	Ø60	Ø76

Input Voltage:  
220 - 240VAC

					
<b>Empty</b>				<b>Empty</b>	<b>IP33</b>

<b>Code</b>	<b>YZTH-859-*</b>	<b>01-006-*</b>	<b>01-008-*</b>	<b>YZTH-862-*</b>	<b>521LED-MT</b>	<b>LH-5004P</b>
Max Power	70W-150W	70W-150W	70W-150W	70W-150W	Max. 150W	Max. 100W
Lamp Holder	E27	E27	E27	E27	E27	E27
Size (mm)	Ø738 x 560	Ø700 x 460	1000 x 1200	Ø380 x 333	Ø400	Ø225 x 395
Material	Die Cast Aluminium	Die Cast Aluminium	Die Cast Aluminium	Die Cast Aluminium	Die Cast Aluminium	Die Cast Aluminium
Entry	Ø76	Ø76	Ø89	Ø60	Ø76	Ø60

\* Add type of switch gear required: **70W** (Metal Halide), **150W** (Metal Halide), **EMPTY** (No switch gear)

**POLES**



<b>Code</b>	<b>POLE-3.5M-76</b>
Pole length	3500mm
Pole Top Ø	76mm
Material	Galvanised Steel

## LED SPOTS IP65



LSP-3X3W-12V

LSP-6X3W-24V



DMX-512

Code	Power	Lumen	Size (mm)
LSP-3X3W-12V-*	9W (0.75A) @ 12VDC	1780lm	Ø99 x 129
LSP-6X3W-24V-*	18W (0.75A) @ 24VDC	3400lm	Ø120 x 168

\*Add colour to code: ● R (Red), ● GN (Green), ● BL (Blue), ● Y (Yellow), ●● RGB, ○ CW (Cool White)  
Beam angle - Single colour: 30°, RGB: 40°

### Accessories

Code	Description
DMX-512-12V	DMX controller to control RGB type
IMG-DV512	DMX decoder driver 12/24V, 180W max

Order one DMX controller and at least one decoder driver for each colour changing installation.



IMG-DV512

Supply Voltage 230 VAC				
<b>Code</b>	<b>HLB00802-RGB</b>	<b>HLB00801-WW</b>	<b>SL-T213-*</b>	<b>SL-T211-*</b>
Power	12 x 1.0W (12W)	12 x 1.0W (12W)	6 x 1W (6W)	18 x 1W (18W)
Lumen	552	552	480-540	1440-1620lm
Size (mm)	Ø110 x 208	Ø110 x 208	Ø120 x 200	Ø180 x 260
Light Distance	8m	8m	5m	12m
Colour	RGB	○ WW (Warm White)	*Add colour to code: ○ CW (Cool White), ○ WW (Warm White), ● R (Red), ● BL (Blue), ● Y (Yellow), ● GN (Green)	

## UNDERWATER LIGHTS IP68

Lamps & Transformers Excluded				
<b>Code</b>	<b>C7062</b>	<b>C7052</b>	<b>C7162</b>	<b>LH5001-9A</b>
Lamp	MR16 35W 12V	80W 230V	MR16 35W 12V	MR16 50W 12V
Lamp Type	GU5.3	E27	GU5.3	GU5.3
Material	Stainless Steel	Stainless Steel	Stainless Steel	PBT
Size (mm)	Ø82 x 152 x 110	Ø155 x 260 x 200	Ø82 x 300 x 110	Ø85 x 110
				<b>Colour Lenses -</b> To be ordered separately 
<b>Code</b>	<b>LH5001-4</b>	<b>LH5001-3</b>	<b>DH28462</b>	<b>DH-*</b>
Lamp	MR16 50W 12V	PAR 56 300W 12V	PAR56 120-300W 12V	
Lamp Type	GU5.3	Screw Terminals	Screw Terminals	
Spare Lamp	Brass Nickel Plated	ABS	Stainless Steel	
Size (mm)	Ø95 x 115	Ø228 x 215	Ø215 x 230	
				*Add colour to code: ● R, ● GN, ● BL, ○ CL, ● Y,

## LED UNDERWATER LIGHTS IP68

Supply volts:  
12VDC



Supply volts:  
12VDC



Supply volts:  
12V



Supply volts:  
12V RGB  
c/w remote



Code	HLB01901-*	HLB01801-*	GLD005-*	GLD-RGB-10W
Power	6W	9W	4.5W	10W
Lumen	600lm	900lm	45lm	750lm
Size(mm)	Ø120 x 155	Ø180 x 145	Ø120	Ø75 x 91
Material	304 Stainless Steel	304 Stainless Steel	ABS	Aluminium

\*Add colour to code: ○ **WW** (Warm White), ○ **CW** (Cool White),  
● **BL** (Blue)

\*Add colour to code: ○ **W** (White), ● **R** (Red), ● **G** (Green), ● **BL** (Blue), ●●● **M** (RGB)



Input Voltage: 24VAC/DC | c/w 2 Meter cable

Code	Size (mm)	Watts	No of LEDs
UD14-M	Ø53 x 35	1.5	15
UD15-*	Ø53 x 35	1.5	15

\*Add colour to code: ● **R**, ● **G**, ● **B**, ○ **W**, ● **Y**, ● **P** -M = Multi-colour (Full colour changing ●●●)

## LED AQUA POOL LIGHTS IP68

### Surface Mount



Code	Wattage	Voltage	Lumen	Beam Angle	Size (mm)
P120-*	20W (1700mA)	12-24VAC/DC	1500lm	120°	Ø250 x 50

\*Add colour to code: ○ **W** (White), ● **B** (Blue), ●●● **RGB** (Colour Changing)

### PAR56 Retrofit Lamp



Code	Wattage	Voltage	Lumen	Beam Angle	Size (mm)
PAR120-*	20W (1700mA)	12-24VAC/DC	1500lm	120°	Ø180 x 77

\*Add colour to code: ○ **W** (White), ● **B** (Blue), ●●● **RGB** (Colour Changing)

### Spa and Jacuzzi LED



Code	Wattage	Voltage	Lumen	Beam Angle	Size (mm)
P50SPA-B	4W	12VAC/DC	400lm	60 - 90°	Ø110 x 63

### Aim Flow Powered Pool & Spa LED - Jet Hole Mounting | No External Power Required - Self Generating

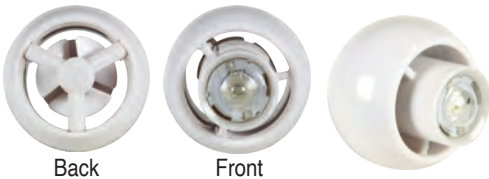

Code	Wattage	Voltage	Lumen	Beam Angle	Size (mm)
JHM-L-*	0,1W	Self Driven	10lm	60-90° (2m)	Ø45 x 40

\*Add colour to code: ○ **CW** (Cool White), ● **BL** (Blue), ● **GN** (Green)

### Niche Mount - Retrofit to a Standard Wet Niche



Code	Wattage	Voltage	Lumen	Beam Angle	Size (mm)
PN10W*	20W	12-24VAC/DC	1500lm	60-90°	Ø300 x 60

\*Add colour to code: ○ **W** (White), ● **B** (Blue)

### Accessories

Code	Description
PN-NICHE	Pool Niche

### Accessories

Code	Description
PLA05	Output 12V, 150VA, Outdoor Transformer, 1-6 pieces
PLA06	10A Underwater Connector
PLA07	PAR56 Pool Light Plastic Case Housing
PLA09	External R.F Remote System,Control device power on/off, Select programme, Synchrony programme



# FIBRE OPTIC POOL LIGHTING

## Solid Core Fibre Optic Side Light

- Economic replacement of neon lighting
- Safe – no safety shield required
- Neutral colour fibre, colour added with light engine

Minimum bend radius: 4 x core diameter

Ambient: -20 to +120°C

Loss: 6%/m

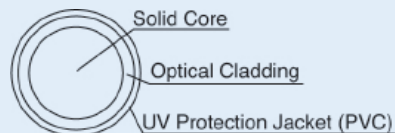

## Solid Core Side Light

Code	Core Ø	Outside Ø	Length	Shielding Colour
OFS-60-30	6mm	8.8mm	30m	Clear
OFS-100-30	10mm	13.0mm	30m	Clear

## Multi-String Side Light

MOFS-3-14-30	–	8.6mm	30m	Clear
MOFS-6-14-30	–	12.6mm	30m	Clear

## Crystifiber Solid Core Side Light

COFS-60-30	6mm	9.4mm	30m	Clear
COFS-100-30	10mm	14.2mm	30m	Clear

Used for lighting of swimming pools, spas and building outlining



## Accessories

Code	Suitable for	Size	Description
NTS-009	OFS-60/MOFS-6/COFS-60	8-9mm	Extended Clip
NTS-012	OFS-100/COFS-100	12-13mm	Extended Clip
OF-2-9	OFS-6/COFS-6	9mm	Crocodile Clip
OF-1-9	OFS-6/MOFS-6/COFS-60	9mm	Clear Channel Plastic 1.8m
OF-1-13	OFS-100/COFS-100	13mm	Clear Channel Plastic 1.8m
OF-3	OFS-60/100, COFS-60/100	–	Fiber Cutter for Solid Core
OF-4	MOFS-6	–	Fibre Cutter for Multi-string



**H-50/100**  
• Wall Mounting  
• Wired Remote



**R-150**  
• Continuous change in colour  
• Colour changed by stepping  
• Fixed colour display  
**R-150 DMX M/S/D**  
• Programmable VID DMX Controller  
• Sound activated  
• Dimming  
• Rainbow effect



**R-150**  
Colour Wheels

## Light Engines (Indoor) 230V

Code	Lamp	Motor	Lamp Life
H-50	Halogen 12V 50W	2-5rpm	4000hrs
H-100	Halogen 12V 100W	2.5rpm	4000hrs
R-150	HQI-R 150W	Stepping	6000hrs
R-150 DMX M/S/D	HQI-R 150W	Stepping	6000hrs
SRC-144	DMX Controller	–	–



DMX Controller

- 54 Channels DMX Output up to 9 projectors
- 4 Digit LED Display showing program/run speed/cross time
- 9 Programs and each program up to 50 steps
- DMX Signal: 3 pin XLR female x1
- Power input: DC 9V-12V 500mA (Adaptor is included)

## Fibre Optic Kits

Code	Light Engine	Fibre Size	No. of Fibres	Length of Fibres	End Piece
FRP-001	LED MINI	0.75mm	155	2m	–
FRP-002	H-20	0.75mm	25 x 4	2, 3, 4, 5m	FO-033
FRP-003	H-35	1.0mm	120	2m	FO-034
FRP-004	H-50 DMX	1.0mm	32	8x0.8m, 6x1.2m, 6x1.8m, 6x2.2m, 6x2.5m	FECU-10-1.0
FRP-005	H-50T	0.75mm	MOFSSS-14 x 1	10m	–

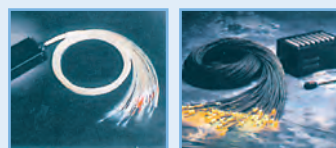

FRP-001

FRP-003



FRP-002

FRP-004



FRP-005

## POOL LIGHTS

### Recessed Mounting

Supply Voltage: 12VAC



Code	PL100-10	PL300-10	PLP300-10	PS100-10
Power	100W	300W	300W	100W
Lamp Type	PAR36 (incl.)	PAR56 (incl.)	PAR56 (incl.)	2 X JC (G6.35) (incl.)
Size (mm)	Ø165 x 110	Ø270 x 125	Ø270 x 125	Ø280 x 50
Spare Lamp	Lamp not replaceable	ACL81	ACL81	-

c/w Standard 10m cable.

Supply Voltage: 12VAC

### LED - Surface Mounting



### LED S/Steel - c/w internal controller



### RGB - with Remote Control Surface Mount



### Plastic Floating Lamps IP67

#### SOL2

#### SOLAR

#### SOLAR



Battery: 1 x NiMh 600mA

Battery: 1 x NiMh 600mA

Code	PAR56-270-CW	PAR56-270-BL	CM-P007-M	PAR56-272-RGB	RW-SLB003	RW-SLB002
Power	15W	15W	12-16W	15W	1W	1W
Lamp Type	White LEDs	Blue LEDs	LED (RGB)	LEDs	2 x LED	2 x LED
Size (mm)	Ø290 x 60	Ø290 x 60	Ø 210mm	Ø290 x 60	Ø120	Ø160



LED PAR 56 & PAR46 Lamp - Supply Volts - 12VAC (Suitable for Swimming Pools)

Code	Power	Lumen (MCD)	*Add Colour to Code:
HG-PAR56-*	18W	R & Y=1500-2500, G=7000-9000	●R / ●G / ●Y
HGPARE56AUTO	18W Auto changing	B=2000-2500, W=6000-8000	●●● Auto
HG-PAR46-*	10W	RGB=2000-3500	●R / ●G / ●B / ●Y / ●W / ●●● M (RGB)

Remote supplied with M (Multicolour) only

OUTDOOR

## LED PAVING BRICK LIGHTS IP67

### LED Paving Brick Lights

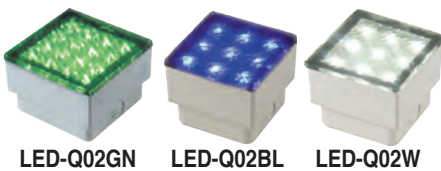

Code	Wattage	No of LED's	Size (mm)
LED-Q02*-†	1.5W	9	80(H) x 80(L) x 68(W)

\*Add colour to code: ○ W (White) ● R (Red), ● GN (Green), ● BL(Blue), ● Y (Yellow),

●●● RGB (auto colour changing)

† Add voltage to code: 230VAC, 24VAC

LIGHTING

## LED FLOOR TILE LIGHTS IP65

• Material: Ceramic Surface with sealed ceramic base (LEDB5 & B6) • Stainless Steel (LEDB7)

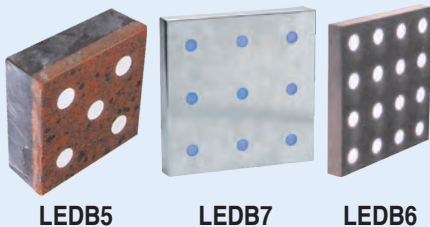

Code	Voltage	Power mA		Size (mm)	No. of Dots	Material
		R, G, Y, B, W	M (R, G, B)			
LEDB5-*	24VDC	20mA (0.48W)	54mA (1.3W)	100 x 100 x 35	5	Ceramic
LEDB6-*	24VDC	100mA (2.4W)	180mA (4.5W)	200 x 200 x 40	16	Marble
LEDB7-*	24VDC	53mA (1.27W)	160mA (3.84W)	200 x 200 x 30	9	Stainless Steel

\*Add colour to code: ● R, ● G, ● Y, ● B, ○ W, ●●● M (R, G, B colour changing)

All Paving Bricks supplied with 2 cables 1 meter long connected with 1x male, 1x female plug.

Power supply to be ordered separately, see page 106-108.

# LED PAVING BRICK LIGHTS IP66

50 000 Hours average life	Rippled Glass	Frosted Glass	Frosted Glass	Marble Finish								
	B1	B2	B3	B4								
<b>Size</b>	100 x 100 x 50mm		100 x 200 x 70mm		200 x 200 x 70mm		200 x 200 x 70mm					
<b>Colour</b>	<b>Code</b>	<b>LUX</b>	<b>mA</b>	<b>Code</b>	<b>LUX</b>	<b>mA</b>	<b>Code</b>	<b>LUX</b>	<b>mA</b>			
● Red	LEDB1-R*	180	20	LEDB2-R 24VDC	63	60	LEDB3-R 24VDC	138	120	LEDB4-R 24VDC	138	120
● Green	LEDB1-G*	508	20	LEDB2-G 24VDC	189	60	LEDB3-G 24VDC	450	120	LEDB4-G 24VDC	450	120
● Yellow	LEDB1-Y*	181	20	LEDB2-Y 24VDC	71	60	LEDB3-Y 24VDC	84	120	LEDB4-Y 24VDC	84	120
● Blue	LEDB1-B*	690	20	LEDB2-B 24VDC	202	60	LEDB3-B 24VDC	600	120	LEDB4-B 24VDC	600	120
White	LEDB1-W*	680	20	LEDB2-W 24VDC	210	60	LEDB3-W 24VDC	246	120	LEDB4-W 24VDC	246	120
R,G,Y,B	LEDB1-M 24VDC	1351	60	LEDB2-M 24VDC	452	180	LEDB3-M 24VDC	1150	360	LEDB4-M 24VDC	1150	360
Colour changing	*Add V to Code 12VDC, 24VDC, 230VAC											

All Paving Bricks supplied with 2 cables 1 meter long connected with 1x male, 1x female plug. Power supply to be ordered separately for 24V

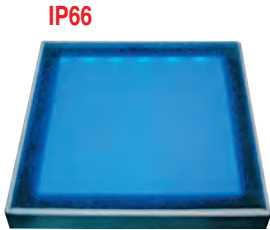

Code	Power mA		No of LEDs	Size (mm)	Material
	R, G, Y, B, W	M (R, G, B)			
LEDB8-***	60mA (1.5W)	180mA (2.88W)	60	100 x 100 x 20	Frosted Glass with S/S trim
LEDB9-***	120mA (5.2W)	360mA (8.64W)	120	200 x 200 x 20	Frosted Glass with S/S trim

\*Add colour to code: ● R, ● G, ● Y, ● B, ○ W, M (●●● R, G, B colour changing [Only in 24VDC]).

\*Add voltage to Code 24VDC, 230VAC

24VDC Supply: Paving Bricks supplied with 2 cables 1 meter long connected with 1x male, 1x female plug. Power supply to be ordered separately.

230VAC Supply: Paving Bricks with 230VAC supply for Indoor use only. Supplied with 200mm single cable.



### Accessories

Code	Description
LED-EP	End Plug for 2 & 4 Pin Plugs IP65

### Power Supplies for Single Colour Paving Lights (2 wire only).

No electronic controller

Code	Volts	Power mA	Watts
PS24-0.4A	230/24VDC 0.4A	0.4A	9.6W
PS24-1A	230/24VDC 1A	1A	24W
PS24-2A	230/24VDC 2A	2A	48W

All Power Supplies supplied with 1 meter cable with 2 Pin female connector

### Extension Cables

EX-12	1 meter 2 core x 0.75mm cable with 1 x male and 1 x female plug
EX-22	2 meter 2 core x 0.75mm cable with 1 x male and 1 x female plug
EX-42	4 meter 2 core x 0.75mm cable with 1 x male and 1 x female plug
EX-52	5 meter 2 core x 0.75mm cable with 1 x male and 1 x female plug

### Power Supplies for Colour Changing Paving Lights (4 wire system). c/w controller

Code	Description	No. B1 Lights	No. B2 Lights	No. B3, B4 or B5 Lights
PSC24-0.4A	230/24VDC 0.4A	5	2	1
PSC24-1A	230/24VDC 1A	12	4	2
PSC24-2A	230/24VDC 2A	23	8	4

All Power Supplies supplied with 1 meter cable with 4 Pin female connector

### Extension Cables

EX-14	1 meter 4 core x 0.75mm cable with 1 x male and 1 x female plug
EX-24	2 meter 4 core x 0.75mm cable with 1 x male and 1 x female plug
EX-44	4 meter 4 core x 0.75mm cable with 1 x male and 1 x female plug
EX-54	5 meter 4 core x 0.75mm cable with 1 x male and 1 x female plug

All Power Supplies supplied with 1 meter cable with 4 Pin female connector

### Application

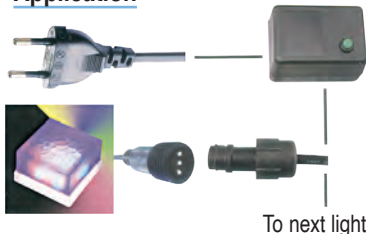

Power Supply	For Colour	Max No of Lights per Power Supply							
		B1	B2	B3, B4	B5	B6	B7	B8	B9
0.4A	R, G, Y, B, W	20	6	3	20	5	7	6	3
	M (RGB)	6	2	1	7	2	2	2	1
1A	R, G, Y, B, W	50	16	8	50	14	18	16	8
	M (RGB)	16	5	3	18	5	6	5	2
2A	R, G, Y, B, W	100	33	16	100	28	37	33	16
	M (RGB)	33	11	5	37	9	12	11	5

2 Year warranty on all LED products, unless otherwise specified. Warranty void if adequate surge protection is not installed on LED products. See page 147

## LED FOOTLIGHTS

**NEW**

**HHB-WF-01**

**Standard Foot Light IP65** - Input Voltage: 230VAC | Beam Angle: 90° | CRI ≥ 80 | Die Cast Aluminium & Glass | Wall Box Excluded, for wall box see BEL-B1

Code	Wattage	Lumens	Cut Out	Size (mm)
<b>HHB-WF-01-*.*</b>	1.5W	45lm	86 x 86mm	95 x 95mm



**HHB-WF-01-S**

**Motion Sensor Foot Light IP65** - Input Voltage: 230VAC | Beam Angle: 90° | CRI ≥ 80 | Sensing Distance: 3m | Sensor Angle: 100° | Time Delay: 3 seconds | Die Cast Aluminium & Glass | Wall Box Exclude, for wall box see BEL-B1

Code	Wattage	Lumens	Lumens	Size (mm)
<b>HHB-WF-01-S-*.*</b>	1.5W	45lm	86 x 86mm	95 x 95mm

\*Add body colour to code: **WH** (White), **BK** (Black), **G** (Gold)

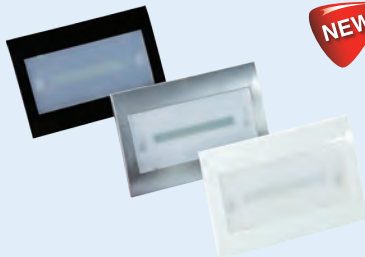
\*Add colour to code: ○ **WW** (Warm White - 2700K), ○ **CW** (Cool White - 4000K)

**NEW**

**Sensor / Emergency Foot Light IP20** - Easy to Install and fits all 4 x 2 wall boxes (wall box excluded) | Dimensions: 115 x 80 x 28mm

Code	Wattage	Lumens	Battery	Backup Time	Function
<b>EMG-FP-NMM-*</b>	2W	160lm	1 x 0.7Ah Li-ion	3h	nm/m
<b>EMG-FP-S-*</b>	2W	160lm	-	-	Sensor

\*Add face plate colour to code: ○ **WH** (White), ● **BK** (Black), ● **S** (Silver)

**SQ06**

### Square LED Lights

Bezel Colour	Code	Size (mm)	Material	IP	Light Output	Power Consumption	LED
Stainless Steel	<b>SQ06-*. *</b>	103L x 103W x 63H	Stainless Steel	<b>IP65</b>	20W	1.6W	30

\* Add colour to code: ○ **WW** (Warm White), ● **R**, ● **G**, ● **B**.

\* Add voltage to code: **12V AC/DC**, **230VAC**. For 12V LED power supply see page 108-110.

**RD02**
**RD04**
**RD05/6**

### Round LED Lights with removable bezel

\*Can be used underwater

Bezel Colour	Code	Size (mm)	Material	IP	Light Output	Power Consumption	LED
WH, BK, C	<b>RD02-*. *</b>	Ø122x53	Plastic	<b>IP68*</b>	20W	1.44W	30
	<b>RD02B-*</b>	*Bezel colour: <b>W</b> (White), <b>G</b> (Gold), <b>C</b> (Chrome), <b>BK</b> (Black), to be ordered separately					

\*Add colour to code: ○ **WW** (Warm White), ● **R**, ● **G**, ● **B**.

\*Add voltage to code: **12V AC/DC**, **230VAC**. For 12V LED power supply see page 108-110.

**RD02** supplied standard with white bezel. Other colour bezel to be ordered separately.

### Round LED Lights

White	<b>RD04-*. *</b>	Ø69x22.5	Aluminium	<b>IP25</b>	11W	0.9W	15
Chrome	<b>RD05-*. *</b>	Ø104x21	Aluminium	<b>IP44</b>	30W	2.9W	48
Chrome	<b>RD06-*. *</b>	Ø93x21	Aluminium	<b>IP44</b>	20W	1.44W	30

\*Add colour to code: ○ **WW** (Warm White), ● **R**, ● **G**, ● **B**.

\*Add voltage to code: **12V AC/DC**, **230VAC**. For 12V LED power supply see page 108-110.

## LED RECESSED WALL LIGHTS

Supply Voltage: 230VAC

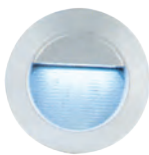

Aluminium



Aluminium



Aluminium



Aluminium



Code	<b>LED-J01*</b>	<b>LED-J02*</b>	<b>LED-J04**</b>	<b>LED-9009**</b>	<b>WL11027-**</b>	<b>WL11028-**</b>
LED's	14 x 0.08W (1.2W)	14 x 0.08W (1.2W)	18 x 0.08W (1.5W)	2 x 1W	4W	4W
Lumens	32lm	32lm	36lm	90lm	120lm	120lm
IP Rating	<b>IP54</b>	<b>IP54</b>	<b>IP54</b>	<b>IP54</b>	<b>IP44</b>	<b>IP44</b>
Size (mm)	Ø126 x 65.5	65.5 x 126 x 126	138 x 140 x 94	132 x 62	165 x 125 x 105	165 x 125 x 105

\*Add colour to code: ○ **CW** (Cool White), ○ **WW** (Warm White) \*Add colour to code: ○ **CW** (Cool White), ● **R** (Red), ● **GN** (Green), ● **BL** (Blue), ● **Y** (Yellow)

\*\*Add colour to code: ○ **CW** (Cool White), ○ **WW** (Warm White), ● **BL** (Blue), ● **R** (Red)



# LED RECESSED WALL LIGHTS

NEW

Supply Voltage: 230VAC



c/w Wall Box



c/w Wall Box



c/w Wall Box

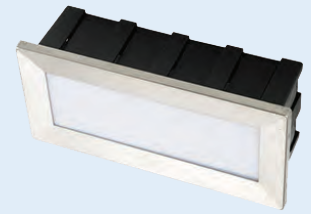

c/w Wall Box

Code	FG07401-*	FG07501-*	FG07601-*	FG07701-*
LED's	1.5W	1.5W	3.5W	3.5W
Lumens	75lm	55lm	195lm	187lm
<b>IP Rating</b>	<b>IP65</b>	<b>IP65</b>	<b>IP65</b>	<b>IP65</b>
Size (mm)	80 x 80 x 61	123 x 53 x 61	135 x 135 x 65	205 x 95 x 65
Material	ST304 + Aluminium			

\*Add colour to code: ○ CW (Cool White), ○ WW (Warm White)

Supply Voltage: 230VAC



c/w Wall Box



c/w Wall Box



c/w Wall Box

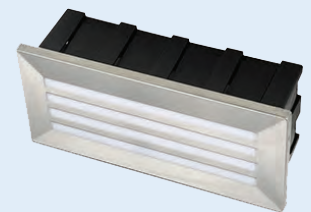

c/w Wall Box

Code	FG07402-*	FG07502-*	FG07602-*	FG07702-*
LED's	1.5W	1.5W	3.5W	3.5W
Lumens	42lm	55lm	136lm	125lm
<b>IP Rating</b>	<b>IP65</b>	<b>IP65</b>	<b>IP65</b>	<b>IP65</b>
Size (mm)	80 x 80 x 61	123 x 53 x 61	135 x 135 x 65	205 x 95 x 65
Material	ST304 + Aluminium			

\*Add colour to code: ○ CW (Cool White), ○ WW (Warm White)

Supply Voltage: 12VAC/DC

Surface Mount

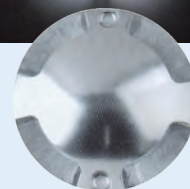
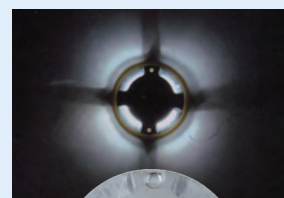
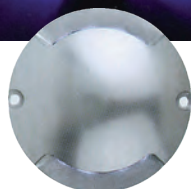
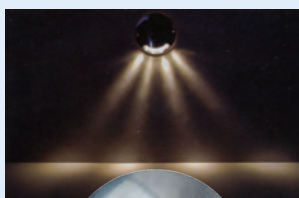





Code	HLH02801-*	HLH02802-*	HLH02804-*	WL11001-*
LEDs	4 x 0.1W (0.4W)	8 x 0.1W (0.8W)	12 x 0.09W (1W)	4 x 0.02 (0.8W)
Lumen	12lm	24lm	36lm	8lm
<b>IP Rating</b>	<b>IP67</b>	<b>IP67</b>	<b>IP67</b>	<b>IP20</b>
Size (mm)	Ø70 x 13	Ø70 x 13	Ø70 x 13	Ø45 x 15



\*Add colour to code: ○ CW (Cool White), ○ WW (Warm White), ● BL (Blue)

2 Year warranty on all LED products, unless otherwise specified. Warranty void if adequate surge protection is not installed on LED products. See page 147

# LED WALL LIGHTS

Supply Voltage: 230VAC		
<b>Code</b>	<b>CIE-L004*</b>	<b>CIE-L010*</b>
LED's	12 x 0.08W (1W)	16 x 0.06W (0.96W)
Lumen	11lm	11lm
<b>IP Rating</b>	<b>IP44</b>	<b>IP23</b>
Size (mm)	190 x 250 x 105	156 x 180 x 130
Material	Stainless Steel	Stainless Steel
*Add LED colour to code: ○ WH (White), ● BL (Blue), ● Y (Yellow), ● GN (Green), ● R (Red)		*Add LED colour to code: ○ W (White), ● BL (Blue), ● Y (Yellow), ● GN (Green), ● R (Red)

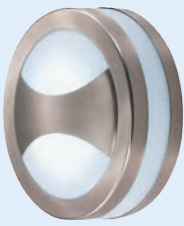
Supply Voltage: 230VAC		
<b>Code</b>	<b>CIE-L015*</b>	<b>CIE-L016*</b>
LED's	18 x 0.06W (1.08W)	18 x 0.06W (1.08W)
Lumen	11lm	25lm
<b>IP Rating</b>	<b>IP44</b>	<b>IP54</b>
Size (mm)	Ø144 x 40	Ø145 x 40
Material	Stainless Steel	Stainless Steel
*Add LED colour to code: ○ WH (White), ● BL (Blue), ● Y (Yellow), ● GN (Green), ● R (Red)		

Supply Voltage: 230VAC			
	<i>Cool White only</i>	<i>Cool White only</i>	<i>Cool White only</i>
<b>Code</b>	<b>KH252</b>	<b>KH252-A</b>	<b>KH252-C</b>
LED's	36 x 0.12W (4.32W)	36 x 0.12W (4.32W)	36 x 0.12W (4.32W)
Lumen	144lm	144lm	144lm
<b>IP Rating</b>	<b>IP44</b>	<b>IP44</b>	<b>IP44</b>
Size (mm)	Ø140 x 55	Ø140 x 55	Ø140 x 55
Material	Stainless Steel	Stainless Steel	Stainless Steel

Supply Voltage: 230VAC			
<b>Code</b>	<b>LED-9006*</b>	<b>LED-9003*</b>	<b>LED-9004*</b>
LED's	36 x 0.08W (2.9W)	36 x 0.08W (2.9W)	36 x 0.08W (2.9W)
Lumen	70lm	70lm	108lm
<b>IP Rating</b>	<b>IP54</b>	<b>IP54</b>	<b>IP44</b>
Size (mm)	Ø140 x 52	Ø140 x 52	Ø140 x 52
Material	Aluminium	Aluminium	Aluminium
*Add colour to code: ○ CW (Cool White), ● R (Red), ● GN (Green), ● BL (Blue), ● Y (Yellow)			

OUTDOOR

LIGHTING

## LED ABS & PC BULKHEADS IP54

Input Voltage: 230VAC | 90 Lumens p/W | Body Material: ABS | Diffuser: Glass

Input Voltage: 230VAC | 90 Lumens p/W | Body Material: ABS | Diffuser: PC

	6000K	6000K		
<b>Code</b>	<b>BL1113-9W-*</b>	<b>BL1112-9W-*</b>	<b>LED-BL1A-C-7W-*</b>	<b>LED-BL1A-C-10W-*</b>
Wattage	9W	9W	7W	10W
Lumen	720lm	720lm	630lm	900lm
Size (mm)	Ø185	Ø185	Ø170 x 55	Ø211 x 55
Colour	White	White	White	White

<b>Code</b>	<b>BL1118-9W-*</b>	<b>BL1117-9W-*</b>	<b>LED-BL1A-O-7W-*</b>	<b>LED-BL1A-O-10W-*</b>
Wattage	9W	9W	7W	10W
Lumens	720lm	720lm	630lm	900lm
Size (mm)	200 x 120	200 x 120	200 x 100 x 55	230 x 105 x 55
Colour	White	White	White	White

 \*Add body colour to code: **WH** (White), **BK** (Black) \*Add colour to code: ○ **CW** (Cool White) 4000K, ○ **WW** (Warm White) 3000K

## LED PLASTIC BULKHEADS

<b>IP65</b>  Clear Prismatic		 Opal		 Opal	
<b>Code</b>	<b>CBH-12W-*</b>	<b>OBH-1-12W-*</b>	<b>OBH-2-12W-*</b>		
Power	12W	12W	12W		
Size (mm)	Ø270 x 60	Ø270 x 60	Ø270 x 115		
Material	Plastic	Plastic	Plastic		

 \* Add Colour to code: ○ **CW** (Cool White) 4000K, ○ **DL** (Day Light) 6000K. For Day-Night Sensor add /DN to code

○ <b>CW</b> - 4000K ○ <b>DL</b> - 6000K Supply Voltage: 85-265VAC Material: Plastic <b>IP54</b>				
<b>Code</b>	<b>LAM12T</b>	<b>LAL010</b>	<b>LAL020 - *</b>	<b>LAL030</b>
Power	12W	12W	18W	22W
Lumen	800lm	800lm	1600lm	2400lm
Size (mm)	290 x 290 x 100	Ø300 x 100	Ø335 x 118	Ø400 x 135
Colour	Black	Black	Black	Black
Colour Temp	DL	DL	* Add Colour to code: <b>CW</b> / <b>DL</b>	DL

○ <b>CW</b> - 4000K ○ <b>DL</b> - 6000K Supply Voltage: 85-265VAC Material: Plastic <b>IP54</b>			
<b>Code</b>	<b>LAL10E</b>	<b>LAL06E</b>	<b>LAL07E</b>
Power	10W	6W	7W
Lumen	550lm	270lm	260lm
Size (mm)	290 x 200 x 100	290 x 200 x 100	290 x 200 x 100
Colour	Black	Black	Black
Colour Temp	DL	DL	DL

# LED PLASTIC BULKHEADS

Supply Voltage: 220-240VAC | Material: Plastic

 Optional	Available in Black and White			
		Day/night sensor non-adjustable, ambient <25lux  		
<b>Code Standard</b>	<b>BL220-12W-*.*</b>	<b>BL220-12W-PIR-*.*</b>	<b>BL270-20W-*</b>	<b>BL320-24W-*</b>
<b>Code Day/Night</b>	<b>BL220-12W-*.*-DN</b>	-	-	-
Wattage	12W	12W	20W	24W
Lumens	840lm	840lm	1500lm	1800lm
<b>IP Rating</b>	<b>IP54</b>	<b>IP54</b>	<b>IP65</b>	<b>IP65</b>
Size (mm)	Ø220 x 99	Ø220 x 99	Ø270 X 102	Ø320 x 113
Colour	White / Black	White / Black	White	White

 Optional					
	<b>Code Standard</b>	<b>UP-AL55-15W-*</b>	<b>LG09A-300-17-*</b>	<b>CL280-CP02-18W-*</b>	<b>CL330-CP02-24W-*</b>
<b>Code Day/Night</b>	<b>UP-AL55-15W-*.DN</b>	<b>LG09A-300-17-*.DN</b>	<b>CL280-CP02-18W-*.DN</b>	-	-
Wattage	15W	17W	18W	24W	18W
Lumen	1500lm	1300lm	1440lm	1920lm	1440lm
<b>IP Rating</b>	<b>IP65</b>	<b>IP54</b>	<b>IP44</b>	<b>IP44</b>	<b>IP44</b>
Size (mm)	Ø300 x 60	Ø305 X 84	Ø280 x 60	Ø330 x 60	280 x 280 x 60
Colour	White	White	White	White	White

\*Add colour to code: ○ CW (Cool White) 4000K, ○ DL (Day Light) 6000K \*Add trim colour to code: ● BK (Black), ○ WH (White)

## RECTANGULAR BULKHEADS

Lamps excluded. For Lamps see Page 6					
<b>Code</b>	<b>BH-01</b>	<b>NB2047-B</b>	<b>BK6001</b>	<b>BK6003</b>	<b>FL1057</b>
Lamp/Watts	B22/60W	E27/100W	E27	E27	E27
<b>IP Rating</b>	<b>IP44</b>	<b>IP54</b>	<b>IP54</b>	<b>IP54</b>	<b>IP65</b>
Size (mm)	220 x 105 x 105	245 x 120 x 115	250 x 175 x 116	280 x 175 x 133	330 x 230 x 190
Material	Plastic	Die-cast Al / Plastic	Plastic	Aluminium / Plastic	Aluminium / Glass

## PLASTIC BULKHEAD IP54

Lamps Excluded	Plastic Opal	Clear Diffused Plastic	Plastic Opal	Clear Plastic	
<b>Code</b>	<b>WH1039-*</b>	<b>WH1040-*</b>	<b>BK1039-2D</b>	<b>BK1040-2D</b>	<b>CL1132</b>
Size (mm)	270Ø x 70		270Ø x 70		270 x 155 x 110
Lamp	*Add type of lamp to code: <b>2D</b> (2D16W), <b>2PL9</b> (2 x 9PL), <b>E27</b> (E27 lamp holder), <b>2D-MS</b> (with microwave motion sensor), <b>2PL9-MS</b> (with microwave motion sensor built into the fitting). These very sensitive sensors work on the same principle as radar. See page 18-19, 6 for more info.		• Black only available in 2D lamp <b>2D-16-4P</b>		E27(CFL/LED)

Note: All fittings on this page that use 2D lamps use the 4-pin lamp, eg. 2D-16-4P-CW

## LED OUTDOOR BULKHEADS IP65

Supply Voltage: 85-265VAC | Colour Temp: 6000K

Supply Voltage: 230VAC <b>NEW</b>				
<b>Code</b>	<b>CL3808-LED</b>	<b>XDF32185-15W</b>	<b>XDY32185-15W</b>	<b>XDY339125-13W</b>
Power	15W	15W	15W	13W
Lumen	1300lm	1200lm	1200lm	1200lm
Size (mm)	Ø325 x 100	250 x 250 x 90	Ø350 x 85	300 x 100 x 85
Material	PC Cover & ABS Base	PC Cover & ABS Base	PC Cover & ABS Base	PC Cover & ABS Base

## PLASTIC BULKHEADS IP65

Lamps excluded			
<b>Code</b>	<b>CL3873</b>	<b>CL3869</b>	<b>CL3819</b>
Lamp	<b>2D-28-4P</b>	<b>2D-28-4P</b>	<b>2D-28-4P</b>
Size (mm)	Ø316 x 125H	Ø280 x 86H	280 x 280 x 87
Material	PC cover and ABS base	PC cover and ABS base	PC cover and ABS base

## 2D PLASTIC BULKHEADS

Lamps excluded					
<b>Code</b>	<b>CL3870</b>	<b>CL3808B</b>	<b>CL2153</b>		
Lamp	<b>2D-28-4P</b>	<b>2D-28-4P</b>	<b>2D-16-4P</b>		
<b>IP Rating</b>	<b>IP65</b>	<b>IP65</b>	<b>IP54</b>		
Size (mm)	Ø330 x 99	Ø325 x 100	Ø257 x 73		
Material	PC cover and ABS base	PC cover and ABS base	PC cover and ABS base		
Lamps Excluded	Chrome Trim	Gold Trim			
<b>Code</b>	<b>CL10021-CH</b>	<b>CL10021-G</b>	<b>CL10022</b>		
Lamp	<b>2D-16-4P</b>	<b>2D-16-4P</b>	<b>2D-28-4P</b>		
Size (mm)	Ø270 x 90	Ø270 x 90	Ø320 x 90		
Material	PC cover ABS base <b>IP54</b>				
Lamps Excluded					
<b>Code</b>	<b>CL10001</b>	<b>CL10002</b>	<b>CL10003</b>	<b>CL10010</b>	<b>CL10018-1</b>
Lamp	<b>2 x PLCE-18</b>	<b>2D-28-4P</b>	<b>2D-28-4P</b>	<b>2D-16-4P</b>	<b>2D-28-4P</b>
Size (mm)	340Ø x 115H	300Ø x 102H	302L x 302W x 93H	305Ø x 68H	305Ø x 80H
Material	PC cover ABS base <b>IP54</b>				

2 Year warranty on all LED products, unless otherwise specified. Warranty void if adequate surge protection is not installed on LED products. See page 147

## LED DIE-CAST ALUMINIUM BULKHEADS IP54

Input Voltage: 220-240VAC | Body Material: Die-cast Aluminium | Diffuser: Glass | Colour Temp: 6000K | Driver on board (DOB)

<b>Code White</b>	<b>BL1112-6W-WH</b>	<b>BL1112-12W-WH</b>	<b>BL1113-6W-WH</b>	<b>BL1113-12W-WH</b>
<b>Code Black</b>	<b>BL1112-6W-BK</b>	<b>BL1112-12W-BK</b>	<b>BL1113-6W-BK</b>	<b>BL1113-12W-BK</b>
Wattage	6W	12W	6W	12W
Lumens	420lm	840lm	420lm	840lm
Size (mm)	Ø192	Ø240	Ø192	Ø240
<b>Code White</b>	<b>BL1115-6W-WH</b>	<b>BL1115-12W-WH</b>	<b>BL1117-6W-WH</b>	<b>BL1117-12W-WH</b>
<b>Code Black</b>	<b>BL1115-6W-BK</b>	<b>BL1115-12W-BK</b>	<b>BL1117-6W-BK</b>	<b>BL1117-12W-BK</b>
Wattage	6W	12W	6W	12W
Lumens	420lm	840lm	420lm	840lm
Size (mm)	Ø192	Ø240	213 x 95 x 107	283 x 162 x 140
<b>Code White</b>	<b>BL1118-6W-WH</b>	<b>BL1118-12W-WH</b>	<b>BL1119-6W-WH</b>	<b>BL1119-12W-WH</b>
<b>Code Black</b>	<b>BL1118-6W-BK</b>	<b>BL1118-12W-BK</b>	<b>BL1119-6W-BK</b>	<b>BL1119-12W-BK</b>
Wattage	6W	12W	6W	12W
Lumens	420lm	840lm	420lm	840lm
Size (mm)	213 x 95 x 107	283 x 162 x 140	213 x 95 x 107	283 x 162 x 140

## BULKHEADS - INDOORS & OUTDOORS IP54

Lamp Type: E27. Lamps Excluded						
<b>Code (White)</b>	<b>NB304001</b>	<b>NB304003</b>	<b>NB1004L-E27</b>	<b>NB304004</b>		
<b>Code (Black)</b>	<b>NB304001-B</b>	<b>NB304003-B</b>	<b>NB1004L-E27-B</b>	-		
<b>Code G24D</b>	<b>NB2026 (2x13W)</b>	<b>NB2024 (2x13W)</b>	<b>NB1004L-G24 (2x13W)</b>	<b>NB2025 (1x13W)</b>		
Lamp	<b>PLC-13</b>	<b>PLCE-13</b>	<b>PLC-13</b>	<b>PLCE-13</b>		
Size (mm)	240Ø x 110	240Ø x 105	240Ø x 128	240Ø x 125		
Material	Die-Cast Aluminium	Die-Cast Aluminium	Die-Cast Aluminium	Die-Cast Aluminium		
Lamp Type: E27. Lamps Excluded						
<b>Code (White)</b>	<b>NB304005-W</b>	<b>NB304007</b>	<b>NB1014L-E27</b>	-	-	-
<b>Code (Black)</b>	<b>NB304005-B</b>	-	-	<b>NB2044</b>	<b>NB2016-S</b>	<b>NB2019-S</b>
<b>Code G24D</b>	<b>NB2031 (1x13W)</b>	<b>NB2030 (1x13W)</b>	<b>NB1014-G24 (2x13W)</b>	-	-	-
Power	1 x 13W	1 x 13W	1 x 13W	1 x 13W	1 x 13W	1 x 13W
Lamp	<b>PLCE-13</b>	<b>PLC-13</b>	<b>PLC-13</b>	<b>PLCE-13</b>	<b>PLCE-13</b>	<b>PLCE-13</b>
Size (mm)	285 x 160 x 130	285 x 160 x 125	212 x 95 x 107	282 x 182 x 110	210 x 145 x 100	210 x 145 x 100
Material	Die-Cast Aluminium	Die-Cast Aluminium	Die-Cast Aluminium	Die-Cast Aluminium	Die-Cast Aluminium	Die-Cast Aluminium

**OUTDOOR**
**LIGHTING**

**BULKHEADS - INDOORS & OUTDOORS IP54**

Lamps Excluded				<b>NEW</b>
<b>Code (White)</b>	<b>NB2033</b>	<b>NB2040A</b>	-	<b>NB44-227-WH</b>
<b>Code (Black)</b>	<b>NB2033-BK</b>	<b>NB2040A-BK</b>	<b>NB2035</b>	<b>NB44-227-BK</b>
Power	1 x 13W	1 x 13W	1 x 13W	2 x 14W Max.
Lamp	<b>PLC-13</b>	<b>PLC-13</b>	<b>PLC-13</b>	2 x E27
Size (mm)	Ø235 x 120	Ø270 x 90	Ø235 x 120	Ø280
Material	Die-Cast Aluminium	Die-Cast Aluminium	Die-Cast Aluminium	Die-Cast Aluminium
Lamps excluded	<b>NEW</b>	<b>NEW</b>	<b>NEW</b>	
<b>Code</b>	<b>MAT-2-ES-C*</b>	<b>MAT-2-ES-O*</b>	<b>MAT-3-ES-O*</b>	
Power	1 x 60W (Max.)	1 x 60W (Max.)	1 x 60W (Max.)	
Lamp Holder	E27	E27	E27	
Size (mm)	Ø270 x 60	Ø270 x 60	Ø270 x 115	
Material	Plastic	Plastic	Plastic	

\* For Day-Night Sensor add **DN** to code

**E27 DECORATIVE BULKHEADS IP54**

Lamps excluded				
<b>Code</b>	<b>NS-1851</b>	<b>NS-1852</b>	<b>NS-1853</b>	<b>NS-1854</b>
Power	60W Max.	60W Max.	60W Max.	60W Max.
Lamp Holder	2 x E27	2 x E27	2 x E27	2 x E27
Size (mm)	300 x 350 x 120	300 x 350 x 120	300 x 350 x 120	300 x 350 x 120
Material	Die-Cast Aluminium	Die-Cast Aluminium	Die-Cast Aluminium	Die-Cast Aluminium
Lamps excluded				
<b>Code</b>	<b>NS-1855</b>	<b>NS-1928A</b>	<b>NS-1928B</b>	
Power	60W Max.	60W Max.	60W Max.	
Lamp Holder	2 x E27	1 x E27	1 x E27	
Size (mm)	300 x 350 x 120	247 x 252 x 110	247 x 252 x 110	
Material	Die-Cast Aluminium	Die-Cast Aluminium	Die-Cast Aluminium	
Lamps excluded				
<b>Code</b>	<b>C300-006</b>	<b>KH554</b>	<b>KH553</b>	
Power	60W/CFL	60W Max	100W max	
Lamp Holder	E27	E27	E27	
<b>IP Rating</b>	<b>IP54</b>	<b>IP54</b>	<b>IP54</b>	
Size (mm)	Ø270 x 100	Ø190 x 100	Ø250 x 100	
Material	Stainless Steel / Glass	Stainless Steel / Glass	Stainless Steel / Glass	

2 Year warranty on all LED products, unless otherwise specified. Warranty void if adequate surge protection is not installed on LED products. See page 147

**LED DECORATIVE BULKHEADS IP54**

Input Voltage: 95-240VAC | 90 Lumens p/w | Body Material: Die-cast Aluminium | Diffuser: PC | Colour Temp: 6000K

<b>Code</b>	<b>LB-1927A</b>	<b>LB-1927B</b>	<b>LB-1927C</b>	<b>LB-1927D</b>
<b>Wattage</b>	10W	10W	10W	10W
<b>Size (mm)</b>	290 x 180 x 90	290 x 180 x 90	290 x 180 x 90	290 x 180 x 90

<b>Code</b>	<b>LB-1932A</b>	<b>LB-1932B</b>	<b>LB-1932C</b>	<b>LB-1932D</b>
<b>Wattage</b>	20W	20W	20W	20W
<b>Size (mm)</b>	Ø280 x 95	Ø280 x 95	Ø280 x 95	Ø280 x 95

<b>Code</b>	<b>LB-1801L</b>	<b>LB-1802L</b>	<b>LB-1803L</b>	<b>LB-1804L</b>
<b>Wattage</b>	20W	20W	20W	20W
<b>Size (mm)</b>	270 x 270 x 80	270 x 270 x 80	270 x 270 x 80	270 x 270 x 80

					<b>DALI Dimmable</b>		
<b>Code</b>	<b>LB-1802LB</b>	<b>LB-1803LB</b>	<b>LB-1804LB</b>	<b>LB-1842</b>	<b>LB-1844</b>	<b>LB-1841-*</b>	<b>LB-1843-*</b>
<b>Wattage</b>	20W	20W	20W	20W	20W	20W	20W
<b>Size (mm)</b>	270 x 270 x 135	270 x 270 x 135	270 x 270 x 135	Ø300 x 100	300 x 300 x 100	Ø300 x 100	300 x 300 x 100

\* Add DALI to Code

**WALL LIGHTS IP44**

Input Voltage: 230VAC



<b>Code</b>	<b>TL-S-TY02A</b>	<b>TL-S-TY02B</b>	<b>TL-S-TY02C</b>	<b>TL-S-TY02D</b>	<b>TL-S-TY02E</b>
<b>Wattage</b>	7W	7W	7W	7W	7W
<b>Lumens</b>	350lm	350lm	350lm	350lm	350lm
<b>Size (mm)</b>	194 x 232 x 162	194 x 232 x 162	Ø162 x 280	Ø162 x 825	Ø162 x 1100

OUTDOOR

LIGHTING

NEW



# OUTDOOR WALL LIGHTS

Solar Wall Light IP44				Solar Pillar Light IP44			
<b>SOLAR</b> <b>SOL2</b> • 6-8 Hrs Normal Brightness • Alu. Body & Glass Lamp • Auto Turn On/Off Dusk/Dawn							Auto on/off PMMA Shade
	<b>Code</b>	<b>JY-0012-A</b>	<b>JY-0007-A</b>	<b>JY-0008-A</b>	<b>JY-0012-B</b>	<b>JY-0007-B</b>	<b>JY-0008-B</b>
<b>Wattage</b>	2.4W	3W	4W	2.4W	3W	4W	1.5W
<b>Lumens</b>	220lm	130lm	220lm	130lm	220lm	220lm	150lm
<b>Size</b>	Ø220 x 530	Ø260 x 400	Ø280 x 360	Ø220 x 550	Ø260 x 430	Ø280 x 390	Ø250x321
<b>Supply Voltage: 230VAC</b>	Green/Black	Black	c/w Chain		Timer: 6s - 12m Sensor: 12m	Timer: 6s - 12m Sensor: 10m/180°	Timer: 6s - 12m Sensor: 10m/180°
<b>Lamps Excluded</b>							
<b>Code</b>	<b>F3225-B/G</b>	<b>F3225</b>	<b>LH-5004H</b>	<b>F3125</b>	<b>F4025</b>	<b>F4034</b>	<b>F4034-2</b>
<b>Power</b>	60W	60W	100W	60W	60W	1 x 150W	2 x 150W
<b>Lamp Holder</b>	E27	E27	E27	E27	E27	E27	E27
<b>IP Rating</b>	<b>IP33</b>	<b>IP44</b>	<b>IP33</b>	<b>IP44</b>	<b>IP33</b>	<b>IP33</b>	<b>IP33</b>
<b>Size (mm)</b>	405 x 203	442 x 195	1025 x 225	346H x 176W	406H x 232W	115 x 160 x 115	270 x 220 x 115
<b>Material</b>	Die-Cast Aluminium	Die-Cast Aluminium	Die-Cast Aluminium	Die-Cast Aluminium	Die-Cast Aluminium	Die-Cast Aluminium	Die-Cast Aluminium
<b>Supply Voltage: 230VAC</b>				Green/Black	Black		
<b>Lamps Excluded</b>							
<b>Code</b>	<b>SS-13014</b>	<b>LH-5029H</b>	<b>LH-5029D</b>	<b>F3025-B/G</b>	<b>F3025</b>	<b>LH-5004D</b>	<b>NY1022-*</b>
<b>Power</b>	75W	60W	60W	60W	60W	100W	100W
<b>Lamp Holder</b>	E27	E27	E27	E27	E27	E27	E27
<b>IP Rating</b>	<b>IP33</b>	<b>IP33</b>	<b>IP33</b>	<b>IP33</b>	<b>IP44</b>	<b>IP33</b>	<b>IP33</b>
<b>Size (mm)</b>	250D x 235H	875 x 245	475 x 395	346 x 176	346 x 176	410 x 260	212 x 336
<b>Material</b>	Die-Cast Aluminium	Die-Cast Aluminium	Die-Cast Aluminium	Die-Cast Aluminium	Die-Cast Aluminium	Die-Cast Aluminium	Die-Cast Aluminium
<b>Supply Voltage: 230VAC</b>						Timer: 20s-8min Sensor: 12m Plastic	c/w built-in daylight switch
<b>Lamps Excluded</b>							
<b>Code</b>	<b>NY1592B</b>	<b>NY1001L-*</b>	<b>YF-B5359</b>	<b>YF-B5352</b>	<b>YF-B5319</b>	<b>F4018</b>	<b>JQ703</b>
<b>Power</b>	100W	100W	60W	60W	60W	100W	26W
<b>Lamp Holder</b>	E27	E27	E27	E27	E27	E27	E27
<b>IP Rating</b>	<b>IP33</b>	<b>IP33</b>	<b>IP33</b>	<b>IP33</b>	<b>IP33</b>	<b>IP33</b>	<b>IP33</b>
<b>Size (mm)</b>	245 x 310	285 x 470	350 x 165	285 x 155	Ø230	210 x 260	Ø230
<b>Material</b>	Die-Cast Aluminium	Die-Cast Aluminium	Die-Cast Aluminium	Die-Cast Aluminium	Die-Cast Aluminium	Die-Cast Aluminium	Die-Cast Aluminium

\*Add colour of fitting to code: **GR** (Grey), **BK** (Black) \*Add colour of fitting to code: **GR** (Grey), **BK** (Black), **B/G** (Black and Green)

2 Year warranty on all LED products, unless otherwise specified. Warranty void if adequate surge protection is not installed on LED products. See page 147

**PMMA LAMP SHADES BAYONET NECK**

Lamp shades c/w galleries. Not to be used with Screw-in galleries



Code 8"	GD01-B-200-O	GD01-B-200-CL	GD01-B-200-SY	GD01-B-200-CP
Code 10"	GD01-B-250-O	GD01-B-250-CL	GD01-B-250-SY	GD01-B-250-CP
Colour	Opal	Clear	Smoky	Clear Prismatic



Code	GD011-O	GD011-CL	GD011-GD	GD012-CL	GD012-GD	GD012-CP
Colour	Opal	Clear	Gold	Clear	Gold	Clear Prismatic

**ACCESSORIES FOR BAYONET NECK**

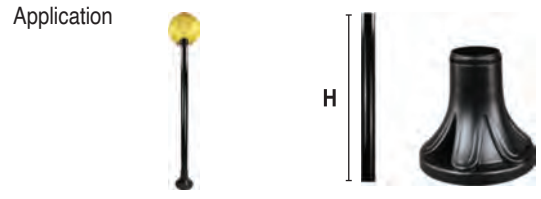

**Short Stand / Long Stand**

Code	Description	Material	Dimensions (mm)
GDB-PL-*	Pole	PVC	Ø60 x 0.5m / 1m / 1.5m / 1.8m
GDB-PB170	Pole Base	ABS	Ø160 x 170

\*Add length to code: 1M, 1.5M, 1.8M

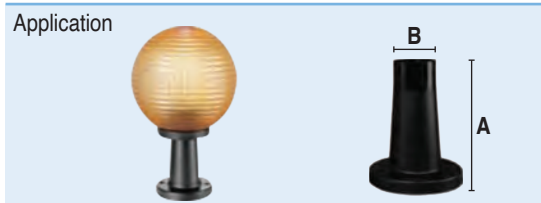

**Short / Long Stand**

Code	A (mm)	B (mm)	For Sphere with Bayonet Neck (mm)
GDB-SS-120	120	Ø60	Maximum Ø200
GDB-LS-160	160	Ø60	Maximum Ø250



**Short / Long Arm Wall Mount**

Code	A (mm)	B (mm)	C (mm)	D (mm)	For Sphere with Bayonet Neck (mm)
GDB-SA-190	190	100	60	32	Maximum Ø250
GDB-LA-310	310	100	60	47	Maximum Ø250

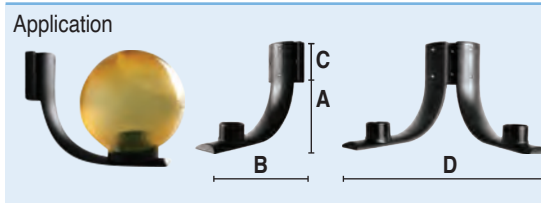

**Single / Double Elbow Wall Mount**

Code	A (mm)	B (mm)	C (mm)	D (mm)	For Sphere with Bayonet Neck (mm)
GDB-S	270	270	125	/	Maximum Ø250



**Basket**

Code	A (mm)	B (mm)	C (mm)	For Sphere with Bayonet Neck (mm)
GDB-B122	122	290	160	Ø250



**Reflector**

Code	A (mm)	B (mm)	C (mm)	D (mm)	Flats	Material	For Sphere with Bayonet Neck (mm)
GDB-R168	168	48	85	50	3	Iron	Maximum Ø200
GDB-R190	190	69	103	68	4	Iron	Maximum Ø250

OUTDOOR

LIGHTING

## OUTDOOR WALL LIGHTS

Supply Voltage: 230VAC				
Lamps Excluded			Clear	Red
<b>Code</b>	<b>RW-360D-*</b>	<b>X1000C (Clear)</b>		<b>X1000R (Red)</b>
Power	9W (900lm)	25W		25W
Lamp Holder	LED	G9		G9
<b>IP Rating</b>	<b>IP65</b>	<b>IP55</b>		<b>IP55</b>
Size (mm)	110 x 120 x 45	Ø90 x 85		Ø90 x 85

\*Add colour to code: ○ CW (Cool White - 4000K), ○ WW (Warm White - 2700K)

Lamps excluded						
	E27	E27	E27	4200K	4200K	4200K
<b>Code</b>	<b>YSC-2002</b>	<b>YSC-2004</b>	<b>YSC-2003</b>	<b>KH820-ADN</b>	<b>KH820-CDN</b>	<b>KH836WU-STONE</b>
Wattage	60W Max	60W Max	60W Max	16 x 0.12W (1.92W)	16 x 0.12W (1.92W)	24 x 0.12W (2.88W)
Lumen	-	-	-	51.2lm	51.2lm	76.8lm
<b>IP Rating</b>	<b>IP44</b>	<b>IP44</b>	<b>IP44</b>	<b>IP44</b>	<b>IP44</b>	<b>IP44</b>
Size (mm)	230 x 260 x 90	230 x 260 x 90	230 x 260 x 90	112 x 90	139 x 90	Ø76 x 220
Material	Die Cast Aluminium	Die Cast Aluminium	Die Cast Aluminium	Stainless Steel	Stainless Steel	Stainless Steel
Colour	Black	Grey	Oxidized	Silver	Silver	White Stone

Supply Voltage: 230VAC								
	NEW	NEW	NEW	NEW				
<b>Code</b>	<b>TL-ST-05B</b>	<b>TL-ST-06B</b>	<b>TL-ST-05A</b>	<b>TL-ST-06A</b>	<b>KH838WU</b>	<b>KH838AWU</b>	<b>KH834-SAWU-W</b>	<b>KH834-AWU-W</b>
Wattage	6W	2 x 6W	6W	2 x 6W	16 x 0.12W (1.92W)	16 x 0.12W (1.92W)	16 x 0.12W (1.92W)	16 x 0.12W (1.92W)
Lumen	300lm	550lm	300lm	550lm	51.2lm	51.2lm	28.8lm	51.2lm
<b>IP Rating</b>	<b>IP44</b>	<b>IP44</b>	<b>IP44</b>	<b>IP44</b>	<b>IP44</b>	<b>IP44</b>	<b>IP44</b>	<b>IP44</b>
Size (mm)	Ø76 x 220 x 115	Ø76 x 200 x 115	Ø76 x 280	Ø76 x 340	Ø10 x 235	Ø101 x 150 x 167	Ø50 x 109 x 198	Ø78 x 142 x 235
Material	Stainless Steel	Stainless Steel	Stainless Steel	Stainless Steel	Stainless Steel	Stainless Steel	Stainless Steel	Stainless Steel
Colour Temp	Cool White	Cool White	Cool White	Cool White	Cool White	Cool White	Cool White	Cool White

Supply Voltage: 230VAC						
Colour Temp.: 4000K					GU10	E27
Dark Grey						
<b>Code</b>	<b>YSC-2034</b>	<b>YSC-2013</b>	<b>YSC-2011</b>	<b>YSC-2017</b>	<b>LD3001-56</b>	<b>NY1836</b>
Wattage	5W	5W	5W	5W	50W	100W
Lumen	500lm	500lm	500lm	500lm	-	-
<b>IP Rating</b>	<b>IP54</b>	<b>IP54</b>	<b>IP54</b>	<b>IP54</b>	<b>IP44</b>	<b>IP54</b>
Size (mm)	76 x 106 x 65	50 x 120 x 180	60 x 242 x 122	100 x 195 x 164	150 x 380	84 x 240
Material	Die Cast Aluminium	Die Cast Aluminium	Die Cast Aluminium	Die Cast Aluminium	Die Cast Aluminium	Die Cast Aluminium







					4000K	4000K
<b>Code</b>	<b>LBD-2360-A-12*</b>	<b>LBD-2360-B-12*</b>	<b>LBD-2460-A-12*</b>	<b>LBD-2460-B-12*</b>	<b>B2365</b>	<b>B2366</b>
Wattage	12W	12W	12W	12W	2 x 5W	2 x 5W
Lumens	1200lm	1200lm	1200lm	1200lm	2 x 500lm	2 x 500lm
<b>IP Rating</b>	<b>IP54</b>	<b>IP54</b>	<b>IP54</b>	<b>IP54</b>	<b>IP54</b>	<b>IP54</b>
Size	Ø170 x 100	Ø170 x 100	160 x 160 x 100	160 x 160 x 100	Ø97 x 134	97 x 97 x 134
Material	Die-Cast Aluminium / PC					

\*Add colour to code: ○ CW (Clear White), ○ WW (Warm White)







2 Year warranty on all LED products, unless otherwise specified. Warranty void if adequate surge protection is not installed on LED products. See page 147

**OUTDOOR WALL LIGHTS**





<p><b>NEW</b></p> <p>Supply Voltage: 230VAC Lamps Excluded S/Steel + PS</p>							
	<b>Code</b>	<b>HC-26402</b>	<b>HC26902</b>	<b>HC-27302</b>	<b>HC-24401</b>	<b>HC-24801</b>	<b>HC-23301</b>
	<b>Power</b>	10W	20W	Max 20W	Max 20W	Max 20W	Max 20W
	<b>Lamp Holder</b>	E14	E27	E27	E27	E27	E27
	<b>IP Rating</b>	<b>IP54</b>	<b>IP54</b>	<b>IP54</b>	<b>IP54</b>	<b>IP54</b>	<b>IP54</b>
<b>Size (mm)</b>	130 x 240 x 170	130 x 240 x 170	224 x 240 x 176	170 x 220 x 210	220 x 285 x 270	250 x 320 x 220	

<b>Supply Voltage:</b> 230VAC	Die-Cast Aluminium Black	Die-Cast Aluminium Black	With day/ night sensor			
<b>Lamps Excluded</b>						

<b>Code</b>	<b>AB-1001-BK</b>	<b>AB-2002-BK</b>	<b>CIE008S</b>	<b>CIE018</b>	<b>CIE053-G-*</b>	<b>CIE052-G-*</b>
<b>Power</b>	10W LED Max.	2 x 10W LED Max.	60W/CFL	60W/CFL	2 x 25W	1 x 25W
<b>Lamp Holder</b>	E27	2 x E27	E27	E27	G9 / E27	G9 / E27
<b>IP Rating</b>	<b>IP33</b>	<b>IP33</b>	<b>IP44</b>	<b>IP44</b>	<b>IP44</b>	<b>IP44</b>
<b>Size (mm)</b>	158 x 250 x 110	95 x 355 x 100	Ø60 x 430	Ø76 x 390	Ø63 x 250	Ø104 x 120

<b>*Add Lamp Holder Type to code: G9, E27</b>						
<b>Supply Voltage:</b> 230VAC						
<b>Lamps Excluded</b>						With day/night sensor

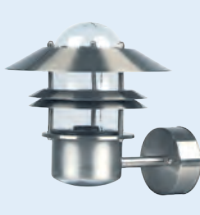
<b>Code</b>	<b>CIE019</b>	<b>CIE015</b>	<b>C300-008</b>	<b>CIE013-A</b>	<b>C300-223</b>	<b>CIE007S</b>
<b>Power</b>	60W/CFL	60W/CFL	60W/CFL	60W/CFL	100W/CFL	60W/CFL
<b>Lamp Holder</b>	E27	E27	E27	E27	E27	E27
<b>IP Rating</b>	<b>IP44</b>	<b>IP44</b>	<b>IP44</b>	<b>IP44</b>	<b>IP44</b>	<b>IP44</b>
<b>Size (mm)</b>	Ø120 x 390	Ø120 x 395	260 x 220 x 90	250 x 300	Ø250 x 380 x 410	Ø200 x 250 x 345

<b>Supply Voltage:</b> 230VAC						
<b>Lamps Excluded</b>						S/Steel body & glass diffuser

<b>Code</b>	<b>KH147-WU</b>	<b>KH148WU+SEN</b>	<b>KH148WU</b>	<b>C300-110</b>	<b>C300-203</b>	<b>KH177AWU</b>
<b>Power</b>	50W max	50W max	50W	60W/CFL	60W/CFL	60W/ CFL
<b>Lamp Holder</b>	GU10	GU10	GU10	E27	E27	E27
<b>IP Rating</b>	<b>IP44</b>	<b>IP44</b>	<b>IP44</b>	<b>IP44</b>	<b>IP44</b>	<b>IP44</b>
<b>Size (mm)</b>	195 x 240	200 x 260	200 x 225	260 x 235	225 x 276	Ø128 x 480

<b>Supply Voltage:</b> 230VAC					
<b>Lamps Excluded</b>	S/Steel & Alum body with PC diffuser				

<b>Code</b>	<b>KH715-BK</b>	<b>KH715</b>	<b>KH715WU-BK</b>	<b>KH715WU</b>	<b>KH246E</b>
<b>Power</b>	60W	60W	60W	60W	60W
<b>Lamp Holder</b>	E27	E27	E27	E27	E27
<b>IP Rating</b>	<b>IP44</b>	<b>IP44</b>	<b>IP44</b>	<b>IP44</b>	<b>IP44</b>
<b>Size (mm)</b>	235 x 445	235 x 445	175 x 345	175 x 345	345 x 100

OUTDOOR

LIGHTING

NEW

UP / DOWN LIGHTS

Supply Voltage: 230VAC  
\*Add colour to code:  
○ WW - 2700K  
○ CW - 4200K



Code	B2344-*	B2344-1-*	B2344-2*	B2282-*	B2283-*	B2284-*
Wattage	2 x 10W	2 x 10W	2 x 10W	2 x 10W	2 x 10W	2 x 10W
Lumen	2000lm	2000lm	2000lm	2000lm	2000lm	2000lm
IP Rating	IP54	IP54	IP54	IP54	IP54	IP54
Size (mm)	179 x 90 x 102	179 x 90 x 102	179 x 90 x 102	200 x 93 x 93	200 x 93 x 93	200 x 93 x 93
Material	Aluminium & Glass	Aluminium & Glass	Aluminium & Glass	Aluminium & Glass	Aluminium & Glass	Aluminium & Glass
Colour Temp	*WW / CW	*WW / CW	*WW / CW	*WW / CW	*WW / CW	*WW / CW

Supply Voltage: 230VAC



Code	HLH00701-*	HLH00102-*	FH14901-*	FH15001-*	Y-LED-3202-2 BK
Wattage	2 x 6W	2 x 20W	10W	2 x 10W	2 x 6.5W
Lumens	1200lm	4000lm	700lm	1400lm	700lm
IP Rating	IP54	IP54	IP54	IP54	IP54
Size	120 x 80 x 200	200 x 150 x 300	144 x 114 x 141	144 x 114 x 211	65 x 91 x 220
Material	Aluminium	Aluminium	Aluminium	Aluminium	Die-Cast Aluminium

\*Add colour to code: ○ CW (Cool White), ○ WW (Warm White)



Code	LED-3041C-1/AL-*	LED-3042C-1/AL-*	LED-3042/AL-*	LED-3042B-1/AL-*	LED-3043-1/AL-*
Wattage	3 x 1W (3W)	6 x 1W (6W)	2 x 1W (2W)	2 x 1W (2W)	2 x 1W (2W)
Lumen	90lm	2 x 90lm	2 x 30lm	2 x 30lm	2 x 30lm
IP Rating	IP44	IP44	IP44	IP44	IP44
Size (mm)	Ø60 x 132	Ø60 x 135	Ø30 x 68	Ø44 x 110	44Ø x 100
Material	Aluminium	Aluminium	Aluminium	Aluminium	Aluminium

\*Add LED colour to code: ○ WH (White), ● BL (Blue), ● Y (Yellow), ● GN (Green), ● R (Red)

Supply Voltage: 230VAC  
Lamps Excluded

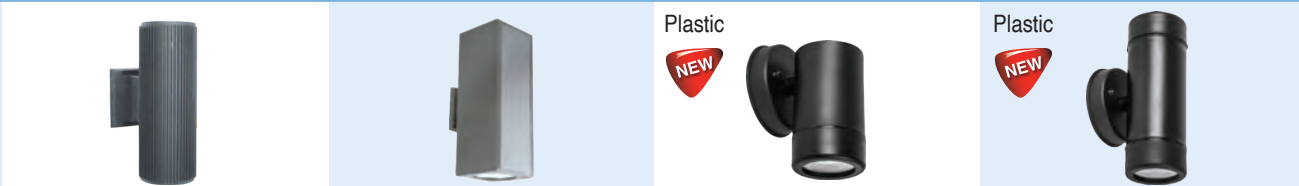

Code	YF-B5475	DH28330	P1602-GU10	P1600-GU10
Power	2 x 60W	2 x 60W	Max 1 x 6W	Max 2 x 6W
Lamp Holder	E27	E27	GU10	2 x GU10
IP Rating	IP44	IP44	IP44	IP44
Size (mm)	90Ø x 260	118 x 181 x 400	87 x 60 x 120	87 x 60 x 158

Supply Voltage: 230VAC  
Lamps Excluded



Code	CIE052-1	CIE053-1	CIE053-3	CIE053-4	CIE0030
Power	35W	2 x 35W	2 x 35W	2 x 35W	2 x 35W
Lamp Holder	GU10	GU10	GU10	GU10	GU10
IP Rating	IP44	IP44	IP44	IP44	IP44
Size (mm)	Ø60 x 113	Ø60 x 162H	Ø60 x 120	Ø60 x 205	Ø60 x 155

2 Year warranty on all LED products, unless otherwise specified. Warranty void if adequate surge protection is not installed on LED products. See page 147

















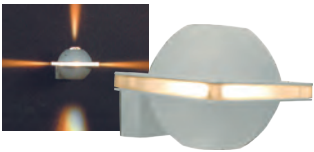





LIT

© ACDC Dynamics

OUTDOOR





LIGHTING

UP / DOWN LIGHTS

Supply Voltage: 230VAC Colour: Grey, Frosted PVC Lamps Excluded							
<b>Code</b>	<b>S7901</b>	<b>S72603</b>	<b>S7903</b>	<b>S72204</b>	<b>S72403</b>	<b>S72201</b>	<b>S72404</b>
Power	4 x 40W	40W	4 x 40W	40W	2 x 50W	2 x 40W	2 x 50W
Lamp Holder	E27	E27	E27	E27	G9	E27	G9
<b>IP Rating</b>	<b>IP54</b>	<b>IP54</b>	<b>IP54</b>	<b>IP54</b>	<b>IP54</b>	<b>IP54</b>	<b>IP54</b>
Size (mm)	Ø65 x 235	Ø90 x 190	Ø90 x 265	Ø90 x 170	Ø90 x 100	Ø110 x 300	Ø90 x 100
Supply Voltage: 230VAC Lamps Excluded							
			Narrow Beam		Wide Beam		
<b>Code</b>	<b>X2000</b>		<b>X1002B-N</b>	<b>X1002B-W</b>	<b>X1001D</b>		<b>B5300A</b>
Power	50W		75W		100W		25W
Lamp Holder	G9		G9		E27		G9
<b>IP Rating</b>	<b>IP54</b>		<b>IP54</b>		<b>IP55</b>		<b>IP54</b>
Size (mm)	Ø130 x 155		150 x 80		Ø170 x 160		Ø108 x 120
Supply Voltage: 230VAC Lamps Excluded							
<b>Code</b>	<b>B2000A</b>	<b>B6400A</b>	<b>B6400B</b>	<b>NY6051</b>			
Power	2 x 50W	50W	2 x 50W	50W			
Lamp Holder	GU10	GU10	GU10	GU10			
<b>IP Rating</b>	<b>IP54</b>	<b>IP54</b>	<b>IP54</b>	<b>IP54</b>			
Size (mm)	272 x 90 x 120	155 x 104	236 x 104	150 x 102			
Material: Metal							
<b>Code</b>	<b>L35-370*</b>	<b>L35-200*</b>	<b>L35-100*</b>	<b>L3543-160*</b>			
Wattage	1 x 10W	1 x 5W	1 x 5W	2 x 4W			
Lumens	800lm	250lm	400lm	480lm			
<b>IP Rating</b>	<b>IP20</b>	<b>IP20</b>	<b>IP20</b>	<b>IP20</b>			
Colour	White	White	White	White			
Size (mm)	370 x 80 x 100	200 x 80 x 100	100 x 80 x 100	160 x 100 x 90			
Material: Metal							
<b>Code</b>	<b>L3544-160*</b>	<b>L3541-160*</b>	<b>L3542-160*</b>	<b>L3536-100B*</b>			
Wattage	2 x 3W	2 x 3W	2 x 3W	2 x 3W			
Lumens	480lm	480lm	480lm	480lm			
<b>IP Rating</b>	<b>IP20</b>	<b>IP20</b>	<b>IP20</b>	<b>IP20</b>			
Colour	White	White	White	White			
Size (mm)	160 x 100 x 90	160 x 100 x 90	160 x 100 x 90	100 x 100 x 100			

\*Add colour to code: ○ CW (Cool White), ○ WW (Warm White)

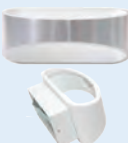

## UP / DOWN LIGHTS

Lamps excluded	 LED 4200K	 LED 4200K	 LED	 LED	 LED
<b>Code</b>	<b>MT2609-2W-SN</b>	<b>MT2609-2W-WH</b>	<b>LED-HALO-6-**-*</b>	<b>L3549-160-*</b>	<b>L3548-160-*</b>
Wattage	2 x 7W	2 x 7W	6W	2 x 3W	1 x 3W
Lumens	1400lm	1400lm	310lm	480lm	240lm
<b>IP Rating</b>	<b>IP20</b>	<b>IP20</b>	<b>IP20</b>	<b>IP20</b>	<b>IP20</b>
Colour	Satin Nickel	Matt White	* W / PA / BLK	White	White
Size (mm)	Ø140 x 350	Ø140 x 350	170 x 100 x 80	160 x 70 x 90	160 x 100 x 90





\*Add colour to code: ○ CW (Cool White), ○ WW (Warm White) \*Add Material colour to code: ○ W (White), ○ PA (Polished Aluminium), ● BLK (Black)

## INDOOR WALL LIGHTS

Supply Voltage: 230VAC

	 LED	 LED	 LED NEW	 LED 4200K	 LED
<b>Code</b>	<b>LS0617-WW</b>	<b>L050A-WW</b>	<b>L060A-DL</b>	<b>V29232-NS</b>	<b>KFD0919</b>
Wattage	1.2W	1W	3W	1 x 40W & 1 x 3W	1 X 60W Max.
Lumens	90lm	90lm	240lm	-	-
Lamp Holder	-	-	-	E27 & LED	E27
Colour	*Add colour to code: ○ DL, ○ WW			200 x 150 x 500	Ø230 x 370
Size (mm)	Ø32 x 350	Ø31 x 390	Ø250 x 35	Stainless Steel	Steel
Material	Aluminium	Aluminium	Aluminium	Satin Nickel	Chrome / White
<b>Reading Lights</b> Arm Length: 400mm	 LED 4200K	 LED NEW	 LED NEW	 LED NEW With USB Port 4200K	 LED NEW With 2 x USB Port 4200K
<b>Code</b>	<b>EL202724-DL</b>	<b>WB-100SC</b>	<b>RL-6326-*</b>	<b>RL-7328-*</b>	<b>LEDB025-*</b>
Power	1W	1 x 3W	3W (210lm)	3W (210lm)	3W(100lm)
Lamp Holder	LED	LED	LED	LED	LED
Size (mm)	Ø65 x 493	160 x 110	Ø150 x 110	Ø150 x 195	Ø150 x 150
Material	Aluminium	Satin Chrome	Aluminium	Aluminium	Aluminium
Colour	Chrome	Satin Chrome	White / Black / Satin Nickel		

\* Add colour to code: ○ WH (White), ● BK (Black), ○ SN (Satin Nickel)

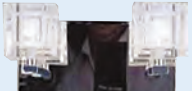
<b>Mirror Light</b>	 LED 4200K	 Lamps excluded	 Lamps excluded	 Lamps excluded	 Lamps excluded	 Lamps excluded
<b>Code</b>	<b>MB-800</b>	<b>FY-2316</b>	<b>HK-149240000</b>	<b>HK-149240001</b>	<b>Y102/1</b>	<b>Y102/2</b>
Power	2 x 36W (Double Sided)	Max. 50W	2 x 40W	3 x 40W	20W	2 x 20W
Lamp Holder	LED	E14	E27	E27	G4	G4
Size (mm)	Ø220	165 x 260 x 140	300 x 90 x 250	W500 x L100 x H250	110 x 110	220 x 110
Material	Electrodeposited Chromium	Aluminium	Glass & Steel	Glass & Steel	Steel, iron & crystal	Steel, iron & crystal
Colour	Chrome	Matt Silver	White	White	Black	Black

 Wall Light	 Wall Light	 Wall Light	 Wall Light	
<b>Code</b>	<b>HF-12-1908H</b>	<b>HF-12-1934H</b>	<b>HF-12-1942H</b>	<b>HF-12-1952H</b>
Lamp Holder	E27	E27	E27	E27
Material	Metal Body, Glass Cover	Metal Body, Glass Cover	Metal Body, Glass Cover	Metal Body, Glass Cover

2 Year warranty on all LED products, unless otherwise specified. Warranty void if adequate surge protection is not installed on LED products. See page 147

**CEILING LIGHTS**

	Opal Fittings		Clear Fittings	
Lamps excluded				
<b>Code</b>	<b>NB250-P</b>	<b>NB280-P</b>	<b>NB250-PCL</b>	<b>NB280-PCL</b>
Size	6"	8"	6"	8"
Lamp Holder	B22/PVC	B22/Porcelain	B22/PVC	B22/PVC
Material	PVC Bowl	PVC Bowl	PVC Bowl	PVC Bowl
Spare Bowl	<b>NB250-P-DIF</b>	<b>NB280-P-DIF</b>	<b>NB250-PCL-DIF</b>	-
Glass Bowl	<b>NB250-G</b>	-	-	-

	Clear Prismatic Fittings		Smoky Fittings		Opal Fitting + Lamp
Lamps excluded					All in one 
<b>Code</b>	<b>CDS1-150-CP</b>	<b>CDS1-200-CP</b>	<b>CDS1-150-S</b>	<b>CDS1-200-S</b>	<b>NB250-5W-*</b>
Size	6"	8"	6"	8"	6"
Lamp Holder	E27	E27	E27	E27	B22 / PVC
Material	PMMA Bowl	PMMA Bowl	PMMA Bowl	PMMA Bowl	PMMA Bowl
					*Add Colour to Code: ○ PW, ○ WW

	Jam Jars				Ceramic / Nylon	
Lamps excluded						
					For 6" bowl	For 8" bowl
<b>Code</b>	<b>JJ60-B22</b>	<b>PJ60-B22</b>	<b>GD008-S</b>	<b>GD008-L</b>	<b>CLH22-3-C (Ceramic)</b>	<b>CLH22-8-C (Ceramic)</b>
Lamp/Watts	B22/60W	B22/60W	E27	E27	B22 / 60W	B22 / 60W
Material	Glass	PMMA	PMMA	PMMA	Ceramic or Nylon	Ceramic or Nylon
Size (mm)	Ø90 x 190	Ø90 x 190	Ø85 x 170	Ø140 x 270	Ø105 x 50	Ø120 x 30H
<b>Code</b>	<b>JJ60-9W-*</b>	<b>JJ60-9W-*</b>	<b>GD008-S-9W-*</b>	<b>GD008-L-20W-WW</b>		
Damp/Watts	B22/9W	B22/9W	E27/9W	E27/20W		
Material	PMMA	Glass	PMMA	PMMA		
Size (mm)	Ø90 x 190	Ø90 x 190	Ø85 x 270	Ø140 x 270		

Lamps included						
<b>Code</b>	<b>PJ60-9W-*</b>	<b>JJ60-9W-*</b>	<b>GD008-S-9W-*</b>	<b>GD008-L-20W-WW</b>		
Damp/Watts	B22/9W	B22/9W	E27/9W	E27/20W		
Material	PMMA	Glass	PMMA	PMMA		
Size (mm)	Ø90 x 190	Ø90 x 190	Ø85 x 270	Ø140 x 270		

\*Add colour to code: ● WW (Warm White) 3200k, ○ CW (Cool White) 4000k

	LED		LED	
Supply Voltage: 230VAC				
<b>Code</b>	<b>MX-236-15W</b>	<b>MX-238-8W</b>	<b>MX-262-400</b>	<b>MX-263-400</b>
Power	15W	8W	26W	26W
Lumen	1300lm	600lm	2210lm	2210lm
IP Rating	<b>IP20</b>	<b>IP20</b>	<b>IP20</b>	<b>IP20</b>
Colour Temp	4000K	4000K	6000K	6000K
Size (mm)	Ø400 x 65	Ø300 x 50	Ø480 x 50	460 x 460 x 50
Material	PC base / PC diffuser	PC base / PC diffuser	PC base / PC diffuser	PC base / PC diffuser

	LED		LED		LED
Supply Voltage: 230VAC					
Dimmable & CCT adjustable. c/w remote					
<b>Code</b>	<b>MLS-XD640D-60</b>	<b>LAA12-*</b>	<b>LAA16-*</b>	<b>LAA20-*</b>	<b>MY-380-01</b>
Power	60W	12W	16W	24W	18W
Lumen	4500lm	888lm	1184lm	1480lm	1080lm
IP Rating	<b>IP20</b>	<b>IP20</b>	<b>IP20</b>	<b>IP20</b>	<b>IP20</b>
Colour Temp	2800-6700K	*○CW (4000K) / ○DL (6000K)	*○CW (4000K) / ○DL (6000K)	*○CW (4000K) / ○DL (6000K)	6000K
Size (mm)	Ø646 x 94	Ø260 x 80	Ø300 x 98	Ø385 x 100	Ø380 x 100
Material	Steel base / PC diffuser	Steel base / PC diffuser	Steel base / PC diffuser	Steel base / PC diffuser	Steel base / PC diffuser



## CEILING LIGHT FITTINGS

Supply Voltage:  
230VAC



LED



LED

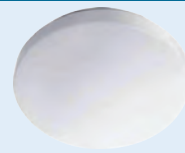

LED



LED

Code	MY-250-01	ASL-005	LAB16	RW6100-15C
Power	12W	20W	16W	10W
Lumen	720lm	1100lm	900lm	600lm
IP Rating	<b>IP20</b>	<b>IP20</b>	<b>IP20</b>	<b>IP20</b>
Colour Temp	6000K	6000K	6000K	6000K
Size (mm)	Ø280 x 80	Ø350 x 105	Ø330 x 75	Ø250 x 80
Material	Steel base / PC diffuser	S/S Trim / PC diffuser	PC base / PC diffuser	PC base / PC diffuser

Supply Voltage:  
230VAC



LED



LED



LED



LED



LED

Code	LAC12	LAC18	LAC22	LAD12	LAD22
Power	12W	18W	22W	12W	22W
Lumen	888lm	1350lm	1650lm / 1440lm	900lm	1650lm
IP Rating	<b>IP20</b>	<b>IP20</b>	<b>IP20</b>	<b>IP20</b>	<b>IP20</b>
Colour Temp	6000K	6000K	6000K	6000K	6000K
Size (mm)	Ø260 x 100	Ø330 x 100	Ø400 x 100	Ø260 x 100	Ø400 x 100
Material	Steel base / PC diffuser	Steel base / PC diffuser	Steel base / PC diffuser	Steel base / PC diffuser	Steel base / PC diffuser

Supply Voltage:  
230VAC



LED



LED



LED



LED



LED



LED

Code	LAE12	LAE22	MY-250-06	MY-380-06	L29199-230	L29199-280
Power	12W	22W	12W	18W	12W	15W
Lumen	900lm	1650lm	660lm	990lm	1200lm	1500lm
IP Rating	<b>IP20</b>	<b>IP20</b>	<b>IP20</b>	<b>IP20</b>	<b>IP20</b>	<b>IP20</b>
Colour Temp	6000K	6000K	6000K	6000K	6000K	6000K
Size (mm)	Ø260 x 100	Ø400 x 100	Ø340 x 100	Ø380 x 105	Ø230	Ø280
Material	S/S Trim / PC diffuser	S/S Trim / PC diffuser	S/S Trim / PC diffuser	S/S Trim / PC diffuser	S/S Trim / PC diffuser	S/S Trim / PC diffuser



Trim Rings

Code	XCL-1728-*	XCL-1738-*	XCL-1743-*
Power	12W	24W	36W
Lumen	900lm	1800lm	2700lm
IP Rating	<b>IP44</b>	<b>IP44</b>	<b>IP44</b>
*Colour Temp	<b>CW</b> (4200K), <b>DL</b> (6000K)	<b>CW</b> (4200K), <b>DL</b> (6000K)	<b>CW</b> (4200K), <b>DL</b> (6000K)
Size (mm)	Ø280 x 63	Ø380 x 63	Ø435 x 63
Material	Steel body + ABS diffuser	Steel body + ABS diffuser	Steel body + ABS diffuser
White Trim	<b>XCL-1728-TR-WH</b>	<b>XCL-1738-TR-WH</b>	<b>XCL-1743-TR-WH</b>
Black Trim	<b>XCL-1728-TR-BK</b>	<b>XCL-1738-TR-BK</b>	<b>XCL-1743-TR-BK</b>
Wood Finish Trim	<b>XCL-1728-TR-WD</b>	<b>XCL-1738-TR-WD</b>	<b>XCL-1743-TR-WD</b>

Input Voltage: 230VAC | Trim Rings available in White, Black or Wooden Finish | Trim Ring to be ordered Separately

Lamps excluded



Code	HF-12-1908F	HF-16-1908F	HF-12-1934F	HF-16-1934F	HF-12-1942F	HF-16-1942F	HF-12-1952F	HF-16-1952F
Lamp Holder	2 x E27	2 x E27	2 x E27	2 x E27	2 x E27	2 x E27	2 x E27	2 x E27
Size (mm)	Ø300 (12")	Ø400 (16")	Ø300 (12")	Ø400 (16")	Ø300 (12")	Ø400 (16")	Ø300 (12")	Ø400 (16")
Material	Metal Body, Glass Cover		Metal Body, Glass Cover		Metal Body, Glass Cover		Metal Body, Glass Cover	

2 Year warranty on all LED products, unless otherwise specified. Warranty void if adequate surge protection is not installed on LED products. See page 147

LIT

© ACDC Dynamics

## CEILING LIGHTS

Lamps Excluded				
<b>Code</b>	<b>HK-149280003</b>	<b>DL-118-C</b>	<b>DL-0208</b>	<b>DL-0211</b>
Power	3 x 60W	1 x 60W	1 x 60W	1 x 60W
Lamp Holder	E27	E27	E27	E27
Size (mm)	400 x 400 x 85	235 x 235	190 x 190	215 x 215
Material	Glass & Steel	Clear Glass	Clear Glass	Clear Glass
<b>Code</b>	<b>GCL-0508-S</b>	<b>GCL-0508-R</b>	<b>GCL-0510-S</b>	<b>GCL-0510-R</b>
Power	1 x 40W	1 x 40W	1 x 40W	1 x 40W
Lamp Base	E27	E27	E27	E27
Size (mm)	200 x 200	Ø200	250 x 250	Ø250
Material	Metal Base / Glass	Metal Base / Glass	Metal Base / Glass	Metal Base / Glass
Colour	Opal	Opal	Opal	Opal

**NEW**

## CEILING SPOT LIGHTS

Base Size: Ø80mm Lamps Excluded					
<b>Code</b>	<b>KT-0004-1-SN</b>	<b>KT-0004-2-SN</b>	<b>KT-0006-2GM</b>	<b>KT-0004-3-SN</b>	<b>KT-0004-5-SN</b>
LED Power	1 x GU10	2 x GU10	2 x GU10	3 x GU10	3 x GU10
Size (mm)	110 x 80 x 105	275 x 80 x 145	Ø150 x 100	440 x 85 x 140	250 x 230 x 145
Colour	Satin Nickel	Satin Nickel	Gun Metal	Satin Nickel	Satin Nickel

Base Size: Ø80mm Lamps Excluded				
<b>Code</b>	<b>KT-6005-1-*</b>	<b>KT-6005-2-*</b>	<b>KT-6005-3-*</b>	<b>KT-6005-5-*</b>
LED Power	1 x GU10	2 x GU10	3 x GU10	3 x GU10
Size (mm)	105 x 80 x 90	275 x 80 x 110	485 x 80 x 110	250 x 230 x 145
Colour	<b>SN / WH</b>	<b>SN / WH</b>	<b>SN / WH</b>	<b>SN / WH</b>

\*Add fitting colour to code: **SN** (Satin Nickel) or **WH** (White)

Shade Size: Ø52 x 75mm Lamps Excluded				
<b>Code</b>	<b>KT-0001-1*</b>	<b>KT-0001-2*</b>	<b>KT-0001-3*</b>	<b>KT-0001-4*</b>
LED Power	1 x GU10	2 x GU10	3 x GU10	4 x GU10
Size (mm)	150 x 90 x 140	320 x 80 x 140	460 x 80 x 140	260 x 220 x 140
Colour	White/Black	White/Black	White/Black	White/Black

\*Add **-BK** to code for Black

## CEILING SPOT LIGHTS

Base Size: Ø80mm Lamps Excluded 				
<b>Code</b>	<b>KT-0006-1</b>	<b>KT-0006-2</b>	<b>KT-0006-3</b>	<b>KT-0006-5</b>
LED Power	GU10	GU10	GU10	GU10
Size (mm)	80 x 135 x 115	275 x 160 x 135	385 x 160 x 135	360 x 360 x 150
Colour	Satin Nickel / Frosted Glass	Satin Nickel / Frosted Glass	Satin Nickel / Frosted Glass	Satin Nickel / Frosted Glass
Beam Angle: 30° Colour Temp: 4000K				
<b>Code</b>	<b>SLD07W1C-*</b>	<b>SLD07W2E-*</b>	<b>SLD07W3E-*</b>	<b>SLD07W3C-*</b>
LED Power	5W	10W	16W	16W
Size (mm)	Ø90 x 90	105 x 220	105 x 360	Ø200 x 105
Colour	*Add lamp colour to code: <b>WH</b> (White), <b>CH</b> (Chrome), <b>N</b> (Brushed Nickel)			
Beam Angle: 30° Colour Temp: 4000K				
<b>Code</b>	<b>SLD08W1C-*</b>	<b>SLD08W2A-*</b>	<b>SLD08W3F-*</b>	<b>SLD08W3C-*</b>
LED Power	4.1W	7W	13.5W	13.5W
Size (mm)	Ø90 x 130	150 x 225	150 x 415	Ø200 x 130
Colour	*Add lamp colour to code: <b>CH</b> (Chrome), <b>N</b> (Brushed Nickel)			
Beam Angle: 30° Colour Temp: 4000K				
<b>Code</b>	<b>SLD04W1C-*</b>	<b>SLD04W2A-*</b>	<b>SLD04W3F-*</b>	
LED Power	3.8W	7.6W	11.4W	
Size (mm)	Ø70 x 80	140 x 225	140 x 405	
Colour	*Add lamp colour to code: <b>WH</b> (White), <b>N</b> (Matt Nickel Paint)			
Supply Voltage: 230VAC Colour Changing & White				
<b>Code</b>	<b>SLD40I1E</b>	<b>SLD40I2E</b>	<b>SLD40I3E</b>	<b>SLD40I4E</b>
LED Power	6W	12W	18W	24W
Size (mm)	210 x 140 x 10.5	290 x 175 x 120	430 x 175 x 120	255 x 155 x 250

2 Year warranty on all LED products, unless otherwise specified. Warranty void if adequate surge protection is not installed on LED products. See page 147

## CEILING SPOT LIGHTS

Supply Voltage: 230VAC Lamp excluded						
<b>Code</b>	<b>140010000</b>	<b>140010001</b>	<b>140160000</b>	<b>140160001</b>	<b>54185-1-*</b>	<b>54185-3-*</b>
Power	50W	2 x 50W	50W	2 x 50W	E14	E14
Lamp Holder	GU10	GU10	GU10	GU10	1 x 25W	3 x 25W
Size (mm)	W120 x L144 x H138	W320 x L120 x H141	W100 x L125 x H146	W320 x L120 x H141	Ø120 x 120	Ø200 x 120
Material	Stainless Steel	Stainless Steel	Stainless Steel	Stainless Steel	Plastic + Steel	Plastic + Steel

\* Add to Code: **W** (White) , **S** (Silver)

Supply Voltage: 230VAC Lamps excluded R50 Reflector				
<b>Code</b>	<b>A448-1</b>	<b>A448-2</b>	<b>A448-3R</b>	<b>A448-3P</b>
Power	40W Max	80W Max	120W Max	120W Max
Lamp Holder	E14	E14	E14	E14
Lamp Size (mm)	Ø61 x 140	140 x 160	140 x 160	Ø160 x 140
Turning Angle	270°	270°	270°	270°
Material	Stainless Steel	Stainless Steel	Stainless Steel	Stainless Steel

Supply Voltage: 230VAC Lamps excluded				
<b>Code</b>	<b>SPL-026</b>	<b>SPL-027</b>	<b>SPL-029</b>	<b>SPL-030</b>
Power	60W	60W	60W	60W
Lamp Holder	E27 CFL	E27 CFL	E27 CFL	E27 CFL
Colour	White	White	White	White
Description	1x Lamp fitting	2x Lamp fitting	3x Lamp fitting	2x Lamp fitting

NB: Only Reflective Lamps R60 to be used

<b>Low Voltage</b> c/w 230/12V transformer.			
<b>Code</b>	<b>2RP-5410*</b>	<b>3RP-5410*</b>	<b>3BR-5410*</b>
No. of Way	2 Way	3 Way	3 Way

\*Add fitting colour to code: **S** (Satin Silver) or **W** (White)

## PICTURE LIGHTS

<b>Low Voltage</b> Supply Voltage: 230VAC Lamps excluded				
	Comes as a set of two picture lights	c/w 60W electronic transformer	<b>LED</b>	<b>LED</b>
<b>Code</b>	<b>WL-99177</b>	<b>WL-99369</b>	<b>MT1751-1W</b>	<b>MT1751-2W</b>
Power	20W	2 x 20W	1 x 1W	2 x 1W
Lamp Holder	G4	2 x G4	LED	LED
Size (mm)	Ø6 x 300	Ø10 x 300	180 x 105 x 172	370 x 105 x 172
Material	Metal	Metal	Chrome	Chrome
Colour	Gold and Frosted White	Silver	Chrome / Frosted Glass	Chrome / Grosted Glass

## PICTURE LIGHTING

Type: T5



<b>Code</b>	<b>MB-059-8W</b>	<b>MB-059-14W</b>	<b>MB-059-21W</b>
Wattage	5W	14W	14W
Size (mm)	350 x 320 x 330	614 x 180 x 120	914 x 180 x 120
Material	Matt Silver	Matt Silver	Matt Silver
Spare Lamp	<b>FLT5-8</b>	<b>FLT5-14</b>	<b>FLT5-21</b>

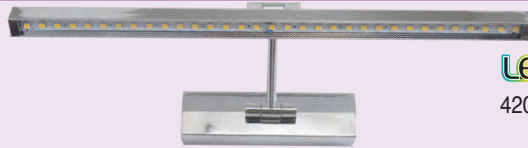

LED  
4200K

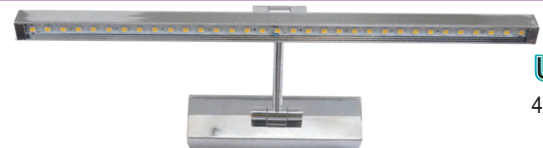

LED  
4200K

<b>Code</b>	<b>MB-501A</b>	<b>MB-509</b>
Wattage	5W	8W
Size (mm)	330 x 180 x 50	480 x 180 x 50
Material	Chrome	Chrome



<b>Code</b>	<b>MB-096-5W-*</b>	<b>MB-096-8W-*</b>	<b>MB-096-12W-*</b>
Wattage	5W	8W	12W
Size (mm)	350 x 150 x 160	480 x 150 x 160	650 x 150 x 160
Material	Chrome	Chrome	Chrome

\*Add colour to code: ○ **CW** (Cool White 4000k), ○ **WW** (Warm White 3000k)

NEW

## LINEAR CEILING LIGHTS

Input Voltage: 230VAC | LED Lamp Included

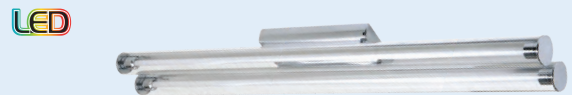

<b>Code</b>	<b>MB-116-12W</b>	<b>MB-116-18W</b>	<b>MB-116/2X12W</b>	<b>MB-116/2X18W</b>
Lamp Holder	LED	LED	LED	LED
Power	1 x 8W	1 x 13W	2 x 8W	2 x 13W
Size (mm)	665 x 60 x 100	965 x 50 x 75	665 x 140 x 100	965 x 60 x 100

Input Voltage: 230VAC | Material: Steel | Body Colour: Satin Nickel | Tubes to be ordered separately



<b>Code</b>	<b>LED-401-2X9</b>	<b>LED-401-2X13</b>	<b>LED-403-2X9</b>
Lamp	LED Tube	LED Tube	LED Tube
Power	2 x 9W	2 x 13W	2 x 9W
Size (mm)	665 x 105	1000 x 150	880 x 160

Input Voltage: 230VAC | Material: Steel | Body Colour: Satin Nickel | Tubes to be ordered separately



<b>Code</b>	<b>LED-403-2X18</b>	<b>LED-404-2X9</b>	<b>LED-404-2X18</b>
Lamp	LED Tube	LED Tube	LED Tube
Power	2 x 18W	2 x 9W	2 x 18W
Size (mm)	1480 x 160	790 x 210	1400 x 210

2 Year warranty on all LED products, unless otherwise specified. Warranty void if adequate surge protection is not installed on LED products. See page 147

LIT

© ACDC Dynamics

NEW

## DECORATIVE CORD

<b>Code</b>	<b>WLIT-C* BL</b>	<b>WLIT-C* BR</b>	<b>WLIT-C* GN</b>	<b>WLIT-C* GR</b>
Description	Blue Cord	Brown Cord	Green Cord	Grey Cord
<b>Code</b>	<b>WLIT-C* R</b>	<b>WLIT-C* BK</b>	<b>WLIT-C* WH</b>	<b>WLIT-C* Y</b>
Description	Red Cord	Black Cord	White Cord	Yellow Cord

\*Add length of cable to code: **2M, 5M, 10M, 100M** Material: Cotton I Size: 2 x 0.75 (6.2mm)

NEW

## DECORATIVE ACCESSORIES

<b>Code</b>	<b>TPLH-E27</b>	<b>LH-E27-WH</b>	<b>LH-E27-BK</b>	<b>LH-E27-CH</b>	
Description	E27 Lamp Holder	White E27 Lamp Holder Kit	Black E27 Lamp Holder Kit	Chrome E27 Lamp Holder Kit	
Material	Black Thermo Plastic	Metal	Metal	Metal	
Size	Ø40 x 60	Ø42 x 62	Ø42 x 62	Ø42 x 62	
<b>Code</b>	<b>LH-E27-VC</b>	<b>LH-E27-VB</b>	<b>LH-E27-GG</b>	<b>LH-E27-VCH</b>	<b>LH-E27-VBK</b>
Description	Vintage Copper Lamp Holder	Vintage Brass Lamp Holder	Gunmetal Grey Lamp Holder	Vintage Chrome Lamp Holder	Vintage Black Lamp Holder
Material	Aluminium	Aluminium	Aluminium	Aluminium	Aluminium
Size	Ø50 x 72	Ø50 x 72	Ø50 x 72	Ø50 x 72	Ø50 x 72

ACCESSORIES

LIGHTING

<b>Code</b>	<b>CR-1-120*</b>	<b>CR-2-120*</b>	<b>CR-3-120*</b>	<b>SHA-PL-5</b>	<b>BCR-1-100-E27*</b>
Description	1 Way Rose	2-Way Rose	3-Way Rose	5-Way Shadow Plate	Ceiling Rose Kit
Material	Metal	Metal	Metal	Metal	Metal
Size (mm)	Ø120 x 25(L)	Ø120 x 25(L)	Ø120 x 25	Ø800 x 30	Ø100 x 25
*Add body colour to code: <b>WH</b> (White), <b>BK</b> (Black), <b>CH</b> (Chrome), <b>BR</b> (Brass)					Cord Length: 1m Packaging <b>VC</b> <b>B</b> <b>VBK</b>
*Add body colour to code: <b>VC</b> (Vintage Copper), <b>B</b> (Bronze), <b>VBK</b> (Vintage Black)					

10 Per Pack						
<b>Code</b>	<b>THT-25/10</b>	<b>THT-120/10</b>	<b>LNUT-M10/10</b>	<b>LWASH-M10/10</b>	<b>CG-13/10*</b>	<b>NWCG-13/10</b>
Description	Threaded Tube	Threaded Tube	Nut	Washer	Cable Grip	Cable Grip
Material	Metal	Metal	Metal	Metal	Plastic	Plastic
Size (mm)	M10 x 25	M10 x 120	M10	M10	Ø13 x 17	Ø13 x 17

\*Add body colour to code: **WH** (White), **BK** (Black), **T** (Transparent)

## LIGHTING ACCESSORIES

<b>Rocker Switch</b>		On/Off switch with 1.5m cable to 2 pin Euro Plug & 1m wire open ended for lamp		<b>Foot Operated Switch</b>		<b>Latching Pushbutton Switch</b>					
Black	White			Black	White	Black	White				
<b>R-303B</b>	<b>R-303W</b>	<b>R-313W</b>		<b>ZE-127FB</b>	<b>ZE-127FW</b>	<b>ZE-127B</b>	<b>ZE-127W</b>				
2 Amp 250V	2 Amp 250V	2 Amp 250V		1 Amp 250V	1 Amp 250V	6 Amp 250V	6 Amp 250V				
<b>Hand Operated Table Lamp Dimmers</b>				Touch control		<b>Foot Dimmer</b>		<b>Breather</b>			
c/w 2,5m cable											
				NEW		NEW		NEW			
White	Black	White	Clear	White	Clear						
<b>KLD-227W</b>	<b>KLD-227G</b>	<b>RT101B</b>	<b>RT101T</b>	<b>RT101SB</b>	<b>RT101ST</b>	<b>RT81N</b>		<b>M12-1.5/5</b>			
Input: 230VAC Lamp: 230VAC Rating: 200W max		Input: 230VAC Lamp: 230VAC Rating: Max 10 LED Lamps (100W Total)		Input: 230VAC Lamp: 230VAC Rating: Max 10 LED Lamps (100W Total)		Input: 230VAC Lamp: 230VAC Rating: Max 10 LED Lamps (100W Total)		Breathing Screw Ø12 x 15 Comes in pack of 5			
<b>NEW</b>				<b>NEW</b>							
<b>Knife Switches</b>				<b>Surge Protectors - Can be installed in fitting or junction box</b>							
				See main catalogue page 266 - 272 for surge protection for distribution boards							
				U							
<b>M29-3P-S</b>		<b>M29-3P-L</b>		<b>Code</b>		<b>LP2-8</b>		<b>GSPD1</b>		<b>GSPD1S</b>	
3 Pin I Rated 400V Class II 27 x 20 x 27		3 Pin I Rated 400V Class II 40 x 30 x 40		Connection		Parallel		Parallel		Parallel	
				Vc		275VAC		120 - 277VAC		120 - 277VAC	
				Up		710V		850V		850V	
				Imax (8/20)		5kA		20kA		10kA	

## LAMP HOLDERS

### Metal Lamp Holders

10mm			10mm Entry				
0142 Authorisation Certificate No. XE2377A	XE2377B		YE317A				
<b>CLH22-10B</b>	<b>CLH22-0B</b>	<b>CLH22-10SW</b>	<b>CLH27-0B</b>	<b>CLH27-10B</b>	<b>CLH14-0B</b>		
B22	B22	B22 (switched)	E27	E27	E14		

### Nylon Lamp Holders

### Illumination Cable & Cable Piercing Lamp Holders

<b>W626</b>	<b>F505-E27</b>	<b>ALH40-0B</b>	<b>CLH14-TH-*</b>	<b>CLH27-TH-*</b>	<b>393</b>	<b>WIR</b>
E27 Angle	Base Mount E27 100W	E40 Batten Mount Aluminium	E14 2A 250V	E27 2A 250V	B22 Cable Piercing Type	<b>WI100* BK</b>
			<b>Spare Locking Ring Code</b>			100m Black Illumination Cable
			<b>CLH14-THLR-*</b>	<b>CLH27-THLR-*</b>		*Add length to code 5m, 10m, 20m, 50m
			*Add colour to code: WH (White),BK (Black)			

2 Year warranty on all LED products, unless otherwise specified. Warranty void if adequate surge protection is not installed on LED products. See page 147

# LAMP HOLDERS

Nylon Lamp Holders		Porcelain Lamp Holder	Bakelite Lamp Holder	Ceramic Lamp Holders	
<b>CLH200*</b>	<b>CLH209A*</b>	<b>CLH22-1P</b>	<b>CLH200T</b>	<b>CLH27-1P</b>	<b>CLH40-1P</b>
B22	B22	B22	E27	E27	E40

\*Add colour to code: ○ WH (White), ● BK (Black) CLH200,CLH209A Also available in pack of 5 Add /5 to code

## Lamp Holders

<b>WIFI-E27</b>	<b>HL001</b>	<b>HL002</b>	<b>W602-B22</b>	<b>W617</b>	<b>W622</b>
E27	B22 / E27 Both Fitted	B22 / E27 Both Fitted	B22	B22 Angle	E27

## Fluorescent Lamp Holders

<b>PT-C01 (set)</b>	<b>PT-C02</b>	<b>PT-C06</b>	<b>PT-C07</b>	<b>PT-C08</b>	<b>PT-C05</b>	<b>PT-C09 (set)</b>
G13	G13	G13	G13	G13	G5	Slimline

<b>MR16-1U/10</b>	<b>MR16-3U/10</b>	<b>MR11-1U/10</b>	<b>LH2-ST</b>	<b>D-GUB</b>	<b>D-CLIP1</b>	<b>D-CLIP2</b>
Spare clip for MR16	Spare clip for MR16	Spare clip for MR11	GU lamp holder c/w terminals & bracket	GU lamp holder c/w terminals & bracket	Spare mounting clip fits SL-076 & 250	Spare mounting clip fits SL-203

## Dichroic Lamp Holders

<b>CLH202</b>	<b>CLH205</b>	<b>CLH206</b>	<b>CLH207</b>	<b>CLH208</b>	<b>CLH209</b>
MR16 (G5.3)	MR16 (G5.3)	MR16 (G5.3)	MR16 (G5.3)	GU10	GV10 (GZ10)
				Bevelled bottom	Square bottom

Rx7s Lamp Holders			
		<b>CLH210</b>	<b>CLH211</b>
		G9	G12
<b>Code</b>	<b>Description</b>		
<b>RX7S-78</b>	To accept 78mm. Lamps up to 150W		
<b>RX7S-118</b>	To accept 118mm. Lamps 150W-500W		
<b>RX7S-189</b>	To accept 189mm. Lamps 1000W		
<b>RX7S-254</b>	To accept 254mm. Lamps 1500W		

ACCESSORIES

LIGHTING



## LAMP HOLDERS

### Starter Holders

Code	PT-B09	PT-B03	A321	CLH22-BT	LH-E27	LHA-E27-1.5m
Description	Starter / Fuse link base with mounting bracket	Starter / Fuse link base	Ceiling Mount Pull Switch 10A	B22 Batten-mount lamp holder with 4m cable, on/off switch and battery clamps 70W max	Pendant - 100W *Add lampholder to code: E27, B22	E27 Lampholder Adaptor with 1.5m 2 x 0.75mm cable

### Lamp Holder Adaptors - <500V

Code	LHA-01	LHA-02	LHA-03	LHA-04	LHA-10	LHA-05
Description	B22-E27	E27-B22	E27-E40	E27-GU10	B22-GU10	E40-E27
Size (mm)	52 x Ø34	50 x Ø33	80 x Ø47	44 x Ø29	52 x Ø35	52 x Ø44
Code	LHA-07	LHA-08	LHA-09	Lamp Tester LT5020		
Description	E14-E27	E27-E14	E40-E40	Buzzer & LED indication if lamp is in working condition. To test: G13, B15d, G5, G4, Gu5.3, GY6.35, E27, E14, E10		
Size (mm)	Ø40 x 64	Ø29 x 44	Ø47 x 99			

## SENSOR LAMP HOLDERS

	Motion Sensor		Lamp Holders with Daylight Sensor		Sound Sensor
Code	RW-450	RW-451	RW-470	RW-471	RW-480
Volts	220-240VAC	220-240VAC	220-240VAC	220-240VAC	220-240VAC
Output	60W (max)	60W (max)	60W (max)	60W (max)	60W (max)
Range/ Angle	6m/120°	6m/360°	-	-	-
Size (mm)	Ø 64 x 127	Ø 56 x 132	Ø 55 x 98	Ø 38 x 75	Ø63 x 95
Light On Timer	120sec	120sec	-	-	60 sec
Ambient Lux	<10lux	<10lux	<10lux	<10lux	3-5lux

## SMART WIFI LAMP HOLDER

Code	Wattage	Voltage	Base
WI-FI-E27	50W	230VAC	E27

**HIGH FREQUENCY SENSOR MODULE**



- 1) Time
- 2) Lux
- 3) Meter
- 4) Standby

**2 Level Light Dimming Function**

Code	HD-627DF	HD-627TF
Rated Voltage	220-240V ~ 50/60Hz	220-240V ~ 50/60Hz
Switching Capacity:	Max. 100W	
Incandescent	Max. 60/80/100W (electronic) / Max. 80W	10 - 100W
AC Halogen / LV Halogen	Max. 100VA/60W	10 - 100W / 10 - 100W
Flourescent / LED Lamp	Max. 30mA Sink Current	5 - 80W (LED Lamp Dimmable)
Energy Saving Lamp	Max. 15pcs Dimmable	10-100VA (Dimmable)
1-10VDC Interface	Ballast or LED Driver	-
Range/Angle	Approx. Ø 8m	Approx. Ø 8m
Size (mm)	75.5 x 49.5 x 32.5H	75.5 x 49.5 x 32.5H
Light ON Timer	5sec - 30min & Test	5sec - 30min & Test
Lux	5Lux - "☀️∞"	5Lux - "☀️∞"

- Auto Dimming
- No movement dims to set level on unit
- With movement full power

**NEW PIR SENSORS IP20**



**Low Profile**

Zero Point Relay Switching



**Long Range - 12m**

Zero Point Relay Switching



Optional remote controller: **MANDOCR (OBI34712)**

Code	CIRCUMAT +	CIRCUMAT PRO CR
Voltage	230VAC	230VAC
Output	1200W Incandescent 400VA Fluorescent 1000VA Low Voltage (12VAC) Halogen Lamps 1200W Halogen (230VAC) 500VA Low Consumption Lamps 500VA Downlight Lamps 500VA LED	2200W Incandescent 1200VA Fluorescent 2000VA Low Voltage (12VAC) Halogen Lamps 2200W Halogen (230VAC) 1000VA Low Consumption Lamps 900VA Downlight Lamps 500VA LED
Range Angle	9m / 360° at 3m(H)	30m / 360° at 12m(H)
Size (mm)	Ø120 x 25	Ø140 x 68
Light on Timer	3s - 30min	1-10min
Lux	5 - 2000Lux	10-1000Lux

**DALI** - Presence Detection Equipped with DALI Two-Way Communication



**1-10V** - Analog Output for Dimmable Lighting Control | Adjust Indoor Lighting Based on Natural Outdoor Light | Suitable for 1-10V Dimmable Lamps



**1-10V** - Presence Detection with Analog Output 1 -10V for Dimmable Lighting Control

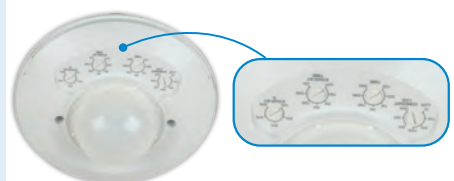

Code	CIRCUMAT-DALI	DICROMAT+1-10V	CIRCUMAT PRO 1-10V
Voltage	230VAC	230VAC	230VAC
Output	-	1200W Incandescent 500VA Fluorescent 1000VA Low Voltage (12VAC) Halogen Lamps 1200W Halogen (230VAC) 500VA Low Consumption Lamps 500VA Downlight Lamps 500VA LED	2200W Incandescent 1200VA Fluorescent 2000VA Low Voltage (12VAC) Halogen Lamps 2200W Halogen (230VAC) 900VA Low Consumption Lamps 900VA Downlight Lamps 500VA LED
Range Angle	30m / 360° at 3.5m(H)	10m / 360° at 2.5m(H)	30m / 360° at 12m(H)
Size (mm)	Ø140 x 68	Ø76 x 68.5	Ø140 x 68
Light on Timer	10s - 30min	10s-30min Twilight mode (On<60 lux, Off>400 lux)	10s-30min
Lux	10 - 2000 lux	100 lux - 2000 lux	10-1000 lux

ACCESSORIES

LIGHTING

## MICROWAVE MOTION SENSORS



Small size allows unit to be mounted inside the light fitting.



Can be surface mounted or hidden in ceiling. Very sensitive.



Fixed 5.8GHz

Code	JQ-25	ECOMAT	ES-M12
Volts	220-240VAC	230VAC	230VAC
Output	1200W Incandescent 500W Fluorescent 500W LV Halogen	1000W Incandescent 500W Fluorescent 500W LV Halogen	1200W Max
Range/ angle	1-8m/ 360°, 160°	6m/270° at 1.7m(H)	10m / 360°
Size (mm)	75 x 41 x 43	116 x 78 x 42	Ø98 x 56mm / cutout Ø76mm
Light On Timer	8sec-10min	3s - 30min	10s - 1, 5, 10, 15, 20, 25, 30min
Lux	< 5 Lux - 2000lux	0.5 - 2000lux	10, 20, 50, 100, 200, 300, 500lux

## RECESSED PIR & MICROWAVE SENSORS IP20

Input Voltage:  
220-240VAC

### Fixed PIR Sensor

### Tiltable



Code	ES-P14	ES-P17A	ES-P17B	ES-P17C	ES-P27B
Detection Angle	360°	360°	360°	360°	360°
Detection Distance	6m Max	6m Max	6m Max	2-20m	6m +
Load	500W Max	1200W Max	1200W Max	2000W (Incandescent) 1000W (Energy Saving)	1200W Max
Time Min/Max	10sec-7min	10sec-7min	10sec-7min	10sec-7min Adjustable	10sec-7min
Lux Min/Max	<10lux - 2000lux	<10lux - 2000lux	<10lux - 2000lux	<10lux - 2000lux Adjustable	<10lux - 2000lux
Dimensions	Ø50 x 66mm	Ø76 x 76mm	Ø100 x 76mm	Ø110 x 90mm	Ø85 x 59mm
Cutout	Ø40mm	Ø61.5mm	Ø76mm	Ø76mm	Ø68mm

## PIR MOTION & LIGHT SENSORS



Ceiling



Ceiling IP20



Flush



Fits standard 4x2 boxes

Wall IP44



Code	ST24	OS-460	OS-472B	OS-472B-A	F4000
Volts	220-240VAC	220-240VAC	220-240VAC		220-240VAC
Output	800W Incandescent Lamp 200W Low Voltage or Fluorescent Lamp	1200W Incandescent	1200W Incandescent	40-500W Incandescent	1300W Incandescent Lights 300W Fluorescent Lights
Range/Angle	360°	11m/360°	Detection Angle 8m/180°		Detection Angle 12m/180°
Size (mm)	Ø18	110 Ø x 32H	115H x 73W		75 x 100 x 115
Light On Timer	5s to 8min	10s to 7min	8 - 420 Sec	10s - 7min	10s to 7min
LUX	10/2000lux	Adj. 3 - 2000 lux	<20lux	Adj. 3 - 2000lux	Adj. 3 - 2000lux
	Passive Infra-Red sensor for automated control • Tiny sensor ball of 35mm Ø • Cut-out hole size 33mm Ø	Built-in photocell allows automatic operation at night and disable during daylight	• No blind spots • Can replace existing 1 way or 2 way switch • No neutral required for OS-472B-A		• Complete with wall bracket

2 Year warranty on all LED products, unless otherwise specified. Warranty void if adequate surge protection is not installed on LED products. See page 147

**PIR MOTION & LIGHT SENSORS**

	Flush	Surface - Flush	Surface
<b>Code</b>	<b>OS-465</b>	<b>FL380</b>	<b>OS-462</b>
Volts	220-240VAC	220-240VAC	220-240VAC
Output	Two loads: L' = 10A for incandescent T1-T2=10A max voltage free contact	2000W Incandescent 1000W ESL	Two loads: L' = 10A max T1-T2=10A max voltage free contact
Range/Angle	6m/360° at 2.4m (H)	12m/360° at 4m (H)	6m/360° at 2.4m (H)
Size (mm)	80Ø x 51 / 110 x 53 x 30	124Ø x 82	113Ø x 39
Light On Timer	L': 6s - 12min, T1-T2:10s - 30min	10s-7min	L': 6s - 12min, T1-T2:10s - 30min
LUX	Fully adjustable Flush mount in ceiling. Dual load for light & ventilation. One additional sensor extendable. <b>Code: OS-465S</b>	<10 - 2000lux 3 x Detector for High sensitivity	Fully adjustable Plug in terminal block for easy installation. Dual load switching 4 element sensor for high sensitivity.

	Ceiling or wall IP45	Ceiling or wall IP44			
<b>Code</b>	<b>OS-181C</b>	<b>JQ26 230VAC</b>	<b>JQ26 12VDC</b>	<b>JQ701</b>	<b>JQ43</b>
Volts	230VAC	220-240VAC	12VDC	220-240VAC	220-240VAC
Output	1840W Incandescent 1000W HV Halogen 300VA LV Halogen 400VA Fluorescent	1100W Incandescent Load	120W Incandescent Load	600W Incandescent load	150W Incandescent load
Range/Angle	10m/270° at 2.5m(H)	12m/180° at 2m(H)		6m ± 2m/ 360°	6m ± 2m/ 360°
Size (mm)	129 x 80 x 63	220 x 86 x 55		85L x Ø73	64L x Ø45
Light On Timer	6s - 10min	8s - 6min		8s - 6min	5s - 8min
LUX	5lux-2000lux Can be fitted to wall or ceiling or a corner. Waterproof. Test function.	2 lux - Daylight Fully weather proof and easy to install.		3 lux - Daylight Easy to mount. Cut-out: Ø56.5mm	10 lux - 2000 lux Easy to mount. Cut-out: Ø40mm

**AIR CONDITONER OCCUPANCY SENSOR**

**Reduce Energy Costs by up to 80%**

EcoSense copies the "off" signal from the A/C remote controller, thereby ensuring the A/C goes through its correct shut down procedure

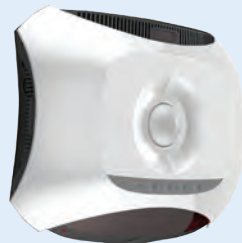

**ECO 2000/4001**



**ECO-RC**



**ECO-WD**



**ECO-PS**

**Eco 2000**

Code	ECOS-2000
Supply Voltage	5x AAA battery (no mains required)
Description	EcoSense 2000 will scan the room for occupancy, when no occupancy has been detected after a pre-set time delay. A signal will be transmitted to the A/C to switch off

**Eco 4001**

Code	ECOS-4001
Supply Voltage	110-230VAC
Description	Universally compatible with any A/C that can be operated by remote controller. This model is mains powered and can be fitted directly adjacent to your A/C unit, therefore no connecting cables will be visible. Compatible with wireless accessories to further increase efficiency.

**Accessories for ECOS-4001**

Code	Description
ECO-RC	Intelligent remote control to limit temperature range
ECO-WD	Wireless door and window sensor - switch off the air conditioner if a door/window is open
ECO-PS	Wireless PIR sensor - for extending detection range

ACCESSORIES

LIGHTING

**NEW REMOTE CONTROL MICROWAVE SENSOR / DIMMING FUNCTION IP65**



MC054V-RC-A

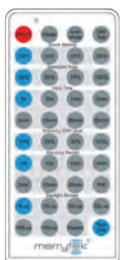

MH01



MS01

**Microwave Sensor** - Parameters can be conveniently set by remote control or via dip settings | Automatic dimming when used in combination with 1-10V dimmable control gear | 1-10V interface can match up stand-alone daylight sensor **MS01** and achieve daylight harvesting

Code	MC054V-RC-A
Rated Load	400W @ 120VAC, 800W @ 220-277VAC (Inductive), 800W @ 120VAC, 1200W @ 220-277VAC (Resistive)
Detection Area	5-7m @ 8m Mounting Height
Hold Time	5s / 30s / 1min / 3min / 5min / 10min / 20min / 30min
Daylight Sensor	Dip Switch & Remote Control 5lux / 15lux / 30lux / 50lux / 100lux / 150lux / disable
Stand-by Period	0s / 10s / 1min / 3min / 5min / 10min / 30min / + ∞
Stand-by Dim Level	10% / 20% / 30% / 50%
Mounting Height	15m Max.
Motion Detection	0.5 ~ 3m/s
Detection Angle	150° (Wall Installation) 360° (Ceiling Installation)
Size	Ø72 x 59mm

**Remote Control** - Works in conjunction with **MC054V-RC-A**

Code	MH01
Description	Remote Set-up Control

**Daylight Sensor / Photocell (for Daylight Harvesting)** - Works in conjunction with **MC054V-RC-A**

Code	MS01
Operating Voltage	1 - 10VDC
Dimming Range	10% - 100%
Mounting Height	3 - 4m
Daylight Sensor	100 - 1000lux
Size	Ø21.5 x 60mm

**DAYLIGHT SWITCHES**

<b>Code</b>	CA-22015	CA-22006	LA10	LA16	CDS-27A	LC-10	LC-11	CDS-15A
Light Off Delay Timer	-	-	30sec		-	-	-	60sec
Load	15A	6A	10A	16A	10A	10A	200W fluorescent	1000W incandescent
Lux	Fixed On 31.5 / Off 12.5 Lux		Fixed On 60 Lux / Off 40 Lux			On ≤20Lux/Off ≥80 Lux		Adj. 5-300 Lux with LED Lux adj. indication

**Panel Fitted Daylight Switch**

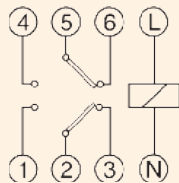

Astro Nova fits inside your distribution board. Enter in your co-ordinate or city & it will control your lights perfectly!

Code	ASTRO NOVA
Accessory (Bluetooth Dongle)	OB709971
Power Supply	230VAC (6VA)
Switching Capacity	16(10)A/250V AC 2C/O
Operating Accuracy	±1sec/day at 23°C
Switching Accuracy	Better than 1 second
Battery Back-up	10 years (Lithium battery)
Memory Spaces	22
Auto change summer/winter	Yes
<b>Max Recommended Load</b>	
Incandescent	3000W
Non-compensated Fluorescent	1200W

OR1

**Daylight Switch IP65**



Size 95(D) x 32(W) x 46(H) mm

Code	MS15	JQ45	JQGM01	LR5 12VDC
Timer	20sec	-	-	-
Load	16A	100W	32W	6A
Lux	Fixed On 60Lux / Off 40Lux	< 10 Lux	< 10 Lux	Fixed On 60Lux / Off 40Lux

**Mini Daylight Switch**



**DC Daylight Switch**



**DIMMERS**

**Universal Dimmer** - Able to dim: LED, Halogen, Incandescent, CFL, Fluorescent | Compatible with all lamp types except constant power lamps | Dimmer control bell press & digital control



**Shuttle Dimmers & Controllers** - LED Dimmers with no Minimum Load/Under Voltage, High Frequency AC Transient & Surge Protection | Fits in Standard 4 x 2 Boxes | Create your own Dimmer with your choice of Plates | Trailing or leading Edge Dimming Method



Dimming Method		Trailing Edge		Leading Edge	Trailing (Default) or Leading Edge
Watts	Amps	Tactile Code	Rotary Code	Tactile Code	Rotary Code
125W	0.55A	DM-125W-LED	-	LDM-125W-LED	-
225W	1A	-	-	-	DMR-225W-LED
500W	2.2A	DM-500W-LED	DMR-500W-LED	LDM-500W-LED	-
800W	3.6A	DM-800W-LED	DMR-800W-LED	-	-

Note: Maximum loading. Dimmer VA X power factor of load.

<b>Code</b>	<b>DIM-CG-100</b>
Power	100W
Input	230VAC Nominal 10%
Min Load	5W
Mode Switch	AC/DC

<b>Multizone Controller</b>	
<b>Code</b>	<b>Description</b>
DM-MZC	Allows co-ordinated or independant control of multiple tactile dimmers

**NEW** **DC PWM Bell Press Dimmer** - Ideal for LED Strip Light

<b>Code</b>	<b>DC-PWM-96W-LED</b>
Input Voltage	9VDC-48VDC
Dimming Range	0.7% - 99.9%
Max. Load Power	96W
Load Type	LED Devices
Size (mm)	36 x 36 x 12

**NEW** **Compact Universal Dimmer** - Easy to turn a traditional switch into a intelligent LED dimmer | Bell Press or Rocker Switch

<b>Code</b>	<b>890300</b>
Input Voltage	230VAC
Dimming Range	100% (6% Steps)
Max. Load	1-100W
Load Type	LED
Size (mm)	36 x 36 x 12

**RTS38**

- CE Approved
- 470kΩ Pot supplied
- EMC Low Noise
- Incandescent or Halogen Lamps

<b>Industrial Dimmer</b>		
<b>Code</b>	<b>Rating</b>	<b>Size (mm)</b>
RTS38	230V 1400W	115 x 105 x 65

**NEW** **ORBIS DIMMER & TIMERS**

**Orbis LED Dimmer** - All Dimmable lamps except 12VDC LEDs operating with electromagnetic transformers | Suitable for Leading and Trailing Edge lamps | Neutral connection not required, only required for LED lamps that flicker or do not turn off | Suitable for 2-way switching

<b>Code</b>	<b>DIM-LED</b>
Input Voltage	230VAC
Adjustment Type	Lamp 1 (Trailing Edge), Lamp 2 (Leading Edge)
Installation	Optional Neutral Connection (based on lamp characteristics)
Minimum Load	3W
Maximum Load	100VA (LED)

**Orbis LED Timer** - All lamp types, except LEDs operating with electromagnetic transformers or any type of fluorescent lights | Adjustable timing | Resettable | Additional push buttons can be fitted | Provides for fans and extractor control.

<b>Code</b>	<b>TEMPO-LED</b>
Input Voltage	230VAC
Timing Range	15s - 15min
Installation	Optional Neutral Connection (based on lamp characteristics)
Minimum Load	3W
Maximum Load	100VA (LED), 50VA (Extractor Fan)

**Orbis LED Timer & Dim** - Initial 100% Lighting intensity during set time. Adjustable from 15s - 15min | After the set time has expired, light intensity is reduced to 25% maintaining a courtesy or safety level of light, either permanently or for a limited period of time (between 7min and 5min). Suitable for all dimmable lamps, except LEDs 12VDC operating with electromagnetic transformers.

<b>Code</b>	<b>TEMPO-LED-2N</b>
Input Voltage	230VAC
Timing Range	15s - 15min
Standby Lighting Timer	1-5min / ∞
Installation	Optional Neutral Connection (based on lamp characteristics)
Minimum Load	3W
Maximum Load	100VA (LED)

ACCESSORIES

LIGHTING

NEW

## LED CONSTANT CURRENT DRIVERS - VS IP20

**Easy Line LED Driver** - Electronic Short-Circuit Protection | Over-Load Protection | Protection Against "No Load" Operation | Protection Class II | Secondary Side Switching of LED Modules is not allowed



Code	Max Output	Current Output DC	Voltage Output DC	Dimensions (mm)
VS186341	12.6W	350mA	8.4 - 36V	123 x 45 x 19
VS186431	20W	350mA	18 - 57V	123 x 45 x 19
VS186350	20.3W	700mA	8 - 29V	123 x 45 x 19
VS186502	47W	1050mA	27 - 45V	171 x 41 x 32

**Easy Line LED Driver - Dimmable** - Dimmable with Phase Cutting Trailing Edge Dimmer | Minimum dimmer load has to be observed (150mA - 700mA / Max 6 - 36W) | Electronic Short-Circuit Protection | Over-Load Protection | Protection Against "No Load" Operation | Protection Class II



Code	Max Output	Current Output DC	Voltage Output DC	Dimensions (mm)
186710	10W	250mA	20-40V	115 x 45 x 25
186449	12W	250mA	27 - 48V	123 x 45 x 19
186415	18W	350mA	32 - 52V	153 x 41 x 32
186416	25W	700mA	22 - 36V	153 x 41 x 32
186451	36W	700mA	32 - 52V	171 x 41 x 32

**Easy Line LED Driver - With Selectable Current** - The required current output can be chosen by selecting the respective pin at the output terminal | Temporary Electronic Short-Circuit Protection | Protection Against "No Load" Operation | Protection Class II | Secondary Side Switching of LED Modules is not allowed



Code	Max Output	Current Output DC	Voltage Output DC	Dimensions (mm)
186463	10W	250mA	17 - 40V	103 x 67 x 31
	14W	350mA		
	20W	500mA		
186531	28.5W	500mA	25 - 57V	103 x 67 x 31
	34.2W	600mA		
	40W	700mA		

**Easy Line LED Driver - DIP Switch** - Selectable current output by Dip Switch | Over load protection | Typical Applications: Shop Lighting, Office Lighting, Residential Lighting and Downlights



Code	Max Output	Current Output DC	Voltage Output DC	Dimensions (mm)
187116	6.3W	150mA	10-42V	97 x 43 x 30
	8.4W	200mA		
	10.5W	250mA		
	12.6W	300mA		
	14.7W	350mA		
	16.8W	400mA		
	18.9W	450mA		
187117	21W	500mA	28-40V	97 x 43 x 26
	24W	600mA		
	26W	650mA		
	28W	700mA		
187119	32W	800mA	28-40V	97 x 43 x 26
	34W	850mA		
	36W	900mA		
	38W	950mA		
	42W	1050mA		

**Comfort Line LED Driver - With Selectable Current** - The required current output can be chosen by selecting the respective pin at the output terminal | Electronic Short-Circuit Protection | Over-Load Protection | Protection Against "No Load" Operation | Protection Class II.



Code	Max Output	Current Output DC	Voltage Output DC	Dimensions (mm)
186444	40W	350mA	57 - 114V	359 x 30 x 21
		500mA	40 - 80V	
		700mA	28 - 57V	
186443	84	350mA	120 - 225V	359 x 30 x 21
		500mA	80 - 170V	
		700mA	60 - 120V	

**NEW**

## LED CONSTANT CURRENT DRIVERS - VS IP20

**Primeline LED Driver - With Programmable Current (Dimmable)** - The output current can be freely adjusted in 1mA steps between 350mA and 700mA (Factory Setting 350mA) | Dimming function is achieved by applying a pwm signal to the nominal current. Dimming Range: 1 to 100%. If no dimming interface is connected, brightness will stay at 100% | Dali and push button dimming is possible | Secondary side switching of LED modules is allowed (Hot wiring).



Code	Max Output	Current Output DC Programable	Voltage Output DC	Dimensions
<b>186465</b>	24W	350 - 700mA	14 - 34V	104 x 67 x 31
<b>186572</b>	37W	350 - 700mA	30 - 53V	125 x 79 x 33
<b>186578</b>	84W	350 - 700mA	60 - 220V	359 x 30 x 21



**LED Set** - The Output Current can be Freely Adjusted Between 275mA and 700mA by Using a Resistor | Dimming function is achieved by applying a pwm signal to the nominal current. Dimming Range: 1 to 100%. | Dali and push button dimming is possible.

**186578  
186565**

<b>186565</b>	42W	275 - 700mA (350mA Factory Set)	30 - 153V	359 x 30 x 21
---------------	-----	------------------------------------	-----------	---------------

## LED CONSTANT CURRENT DRIVERS

### LED Drivers - Constant Current

**CLD-A/ LED-N12**

**LLVC12B-U**

**CLD-B**

Code	Volts In	Volts Out	Current Out	Power	No. of LEDs	Size (mm)
<b>LED-N12-3W</b>	100-250VAC	Up to 5VDC	350mA	3W	1-2 pc x 3W	65 x 35 x 23
<b>CLD-A3536</b>	100-250VAC	Up to 36VDC	350mA	8W	1-8pcs x 1W	65 x 35 x 23
<b>CLD-A7006</b>	100-250VAC	Up to 12VDC	700mA	6.5W	1-2pcs x 3W	65 x 35 x 23
<b>LED-N12-9W</b>	100-250VAC	Up to 21VDC	700mA	9W	1-3pcs x 3W	65 x 35 x 23
<b>CLD-B3503</b>	100-250VAC	Up to 12VDC	350mA	3.5W	1-3pcs x 1W	67 x 37 x 27
<b>CLD-B3536</b>	100-250VAC	Up to 36VDC	350mA	8W	1-8pcs x 1W	67 x 37 x 27
<b>CLD-B7006</b>	100-250VAC	Up to 12VDC	700mA	6.5W	1-2pcs x 3W	67 x 37 x 27
<b>CLD-B7021</b>	100-250VAC	Up to 21VDC	700mA	9W	1-3pcs x 3W	67 x 37 x 27
<b>LLVC12B-U</b>	100-240VAC	13-21VDC	700mA	9-15W	3-5pcs x 3W	85 x 40.4 x 22

### LED Floodlight Drivers - Constant Current

**DRV-GY225TG-10W**

**DRV-GY370FG-60W**

**DRV-GY570FG-80W**

Code	Watts	Size (mm)	Suitable for fitting
<b>DRV-GY225TG-10W</b>	10W	75 x 30 x 20	<b>GY225TG-10W</b>
<b>DRV-GY225TG-20W</b>	20W	85 x 33 x 20	<b>GY225TG-20W</b>
<b>DRV-GY225TG-30W</b>	30W	130 x 42 x 29	<b>GY225TG-30W &amp; GY290TS-30W</b>
<b>DRV-GY290TG-40W</b>	40W	130 x 42 x 30	<b>GY290TG-40W &amp; GY290TS-40W</b>
<b>DRV-GY290TG-50W</b>	50W	130 x 42 x 30	<b>GY290TG-50W &amp; GY290TS-50W</b>
<b>DRV-GY370FG-60W</b>	60W	160 x 42 x 29	<b>GY370FG-60W</b>
<b>DRV-GY370FG-70W</b>	70W	160 x 42 x 29	<b>GY370FG-70W</b>
<b>DRV-GY570FG-80W</b>	80W	160 x 42 x 29	<b>GY570FG-80W &amp; GY470TG-80W</b>
<b>DRV-GY570FG-120W</b>	100-120W	180 x 68 x 42	<b>GY570FG-120W &amp; GY470TG-100W</b>

## DIMMABLE ELECTRONIC TRANSFORMER

Zero Minimum Load

**Indoor IP20**
**Outdoor IP56**

Code	ETZ-60	ETZ-105	ETZ-210	ETW-60	ETW-105	ETW-210
Input Voltage	11.5VAC					
Nominal Input Current	0.27A	0.46A	0.93A	0.23A	0.46A	0.93A
Voltage Output	11.5VAC					
Power Range	0-60W	0-105W	0-210W	0-60W	0-105W	0-210W
Current Output	5.2A	9.1A	18.2A	5.2A	9.1A	18.2A
Size (mm)	95 x 41 x 27H	108 x 44 x 33H	167 x 52 x 38H	73 x 41 x 27H	81 x 44 x 33H	167 x 52 x 38H



**NEW** **LOW VOLTAGE ELECTRONIC TRANSFORMERS IP20**



**Independent Electronic Converters - Liteline** - For low voltage halogen incandescent lamps 12V | Protection against "no load" operation | protection against short-circuit: Electronic switch-off with automatic restart | Suitable for installation in furniture and on combustible surfaces | Dimming: Optional with phase-cutting leading-edge or phase-cutting trailing-edge dimmer



Code	Wattage	Primary	Input Power	Size (mm)
<b>VS186173</b>	10-60W	220-240V	12V	22 x 36 x 103
<b>VS186077</b>	20-105W	230-240V	12V	28 x 37 x 128
<b>VS186098</b>	50-150W	230-240V	12V	33 x 37 x 185



Code	Lamp Watts	V-in	V-out	Size (mm)	Ta	Tc	Hz-in	Hz-out
<b>T-35ET</b>	35W	230-240V	11.2	90 x 40 x 18	-25 – +50°C	50°C	50-60	34kHz
<b>GF-105*</b>	35-105W	230-240V	11.4	146x44x23	-25 – +40°C	75°C	50-60	34kHz
<b>GF-150*</b>	35-150W	230-240V	11.4	166x41x31	-25 – +40°C	75°C	50-60	34kHz
<b>ET210</b>	50-210W	230-240V	11.5	200x43x39	-20 – +50°C	70°C	50-60	34kHz

\*Conformity: EN61046; EN55015; EN61547; EN61000 & EN50082-1. Surge withstanding capability is 3.75kV.

**LOW VOLTAGE TRANSFORMERS**

**Iron Core Transformers 230V/12VAC** complete with fuse. For Halogen Lamps.



Code	Amps @12V	No of Lamps per Transformer		
		50W	35W	20W
<b>L-50VA</b>	4.16A	1	1	2
<b>L-100VA</b>	8.33A	2	2	5
<b>L-150VA</b>	12.5A	3	4	7
<b>L-200VA</b>	16.6A	4	5	10
<b>L-250VA</b>	20.8A	5	7	12
<b>L-300VA</b>	25A	6	8	15
<b>L-350VA</b>	29.16A	7	10	17
<b>L-400VA</b>	33.33A	8	11	20
<b>L-500VA</b>	41.66A	10	14	25

**Iron Core Transformers**  
230/12VAC | Slim type



Code	VA	Amps	Size L x W x H
<b>TRF-105</b>	105	8.75A	239 x 43 x 35

Approved to EN61558-1-7 certified by TÜV

**ELECTRONIC BALLASTS**

**Standard Ballasts**

**T8 Rapid Start**



Single Tube Code T8	Lamp Watts	Size (mm) L x H x W	Double Tube Code T8	Lamp Watts	Size (mm) L x H x W
<b>220-240V Electronic Ballast for T8 lamp rapid start non-dimmable. EEI - A2.</b>					
<b>*L-18E</b>	18W	225 x 28 x 30	<b>*L2-18E</b>	18W	225 x 28 x 30
<b>*L-30E</b>	30W	225 x 28 x 30	<b>*L2-30E</b>	30E	225 x 28 x 30
<b>*L-36E</b>	36W	225 x 28 x 30	<b>*L2-36E</b>	36W	225 x 28 x 30
<b>*L-58E</b>	58W	225 x 28 x 30	<b>*EBT-265</b>	58W	225 x 28 x 30

\* For 110V add voltage to end of code eg: L-18E/110VAC

**T8 Pre-Heat**

T8 3 Lamp			T8 3 or 4 Lamp		
<b>EBT-318</b>	3 x 18W	305 x 28 x 38	<b>L4-18E</b>	4 x 18W	305 x 28 x 38
<b>EBT-336</b>	3 x 36W	365 x 28 x 38	-	-	-
<b>180-264V Compact Ballast for T8 Lamp Pre-heat Start Non-Dimmable</b>					
<b>IC-36E</b>	36W	365 x 28 x 30	<b>IC2-18E</b>	2 x 18W	365 x 28 x 30
<b>IC-58E</b>	58W	365 x 28 x 30	<b>IC2-36E</b>	2 x 36W	425 x 28 x 36
			<b>IC2-58E</b>	2 x 58W	425 x 28 x 36

2 Year warranty on all LED products, unless otherwise specified. Warranty void if adequate surge protection is not installed on LED products. See page 147



**ELECTRONIC BALLASTS**

**T5 Rapid Start**



220-240V Electronic Ballast for T5 lamp rapid start non-dimmable. EEI - A2.

Single Tube Code	Lamp Watts	Size (mm) L x H x W	Double Tube Code T8	Lamp Watts	Size (mm) L x H x W
5L-14E	14W	225 x 28 x 30	5L2-14E	2 x 14W	285 x 28 x 30
5L-21E	21W	225 x 28 x 30	5L2-21E	2 x 21W	285 x 28 x 30
5L-28E	28W	225 x 28 x 30	5L2-28E	2 x 28W	285 x 28 x 30
SIS114-35	14-35W	360 x 30 x 26	-	-	-
5L-24E	24W	280 x 25 x 30	5L2-24E	2 x 24W	280 x 30 x 30
5L-35E	35W	280 x 30 x 30	5L2-35E	2 x 35W	280 x 30 x 30
5L-49E	49W	280 x 30 x 30	5L2-49E	2 x 49W	280 x 30 x 30
5L-54E	54W	280 x 30 x 30	5L2-54E	2 x 54W	280 x 25 x 30

**T5 Pre-Heat**

220-240V Compact Ballast for T5 Lamp Pre-heat Start Non-Dimmable

Single Tube Code	Lamp Watts	Double Tube Code	Lamp Watts	Lamp Type	Size (mm) L x H x W
5IC-24E	24W	5IC2-24E	2 x 24W	T8	425 x 28 x 36
5IC-28E	28W	5IC2-28E	2 x 28W	T8	425 x 28 x 36
5IC-54E	54W	-	2 x 54W	T5	425 x 28 x 36

**Dimmable Ballasts for Fluorescent Lamps**



220-240V Linear Electronic 1-100% Dimmable Ballast: 1-10V control 0.25mA - CFLs: EEI-A1

Single Tube Code	Lamp Watts	Double Tube Code	Lamp Watts	Lamp Type	Size (mm) L x H x W
SD118-40	18 - 36W	SD218-40	2 x 18 - 36W	T8	360 x 30 x 26
SD149	49W	-	-	T5	360 x 30 x 26

• Power factor: 0.98 • Ambient operating temperature (ta) 0°C - +50°C & max. case temperature (tc) 75°C.

• To be used in conjunction with dimmer module DS2F or EP1



**Dimmer Module**

Code	Type of Control	Outputs	Max Power	Size (mm)
DS2F	Push Button Control	2 Sets	250VA	118 x 40 x 25
EP1	Potentiometer	1 Set	250VA	-

Maximum switching power: 250VA = max. 20 Ballasts synchronized simultaneously

ACCESSORIES



220-240V Compact Electronic 2-100% Dimmable Ballast: 1-10V control 0.25mA - CFL's: EEI-A1\*

Single Code	Type	Watts	Double Code	Type	Watts	Size (mm)
TD118	PLC/PLE	18W	TD218	PLC/PLE	2 x 18W	123 x 78 x 305
TD126-42	PLC/PLCE	26-42W	TD226-42	PLC/PLCE	2 x 26-42W	123 x 78 x 305

• Power factor: 0.98. • Ambient operating temperature (ta) 0°C – +50°C & max. case temperature (tc) 75°C. To be used in conjunction with dimmer module DS2F or EP1



220-240V Electronic Ballast for PLCE Lamps

Single Code	Lamp Watts	Size (mm) L x H x W	Double Code	Lamp Watts	Size (mm) L x H x W
LP-13E	7-13W	102 x 30 x 67	-	-	-
LP-18E	18W	102 x 30 x 67	LP2-18E	2 x 18W	102 x 35 x 75
LP-26E	26W	102 x 30 x 67	LP2-26E	2 x 26W	102 x 35 x 75
			LP2-42E	2 x 42W	102 x 35 x 75

LIGHTING



220-240V Digital Electronic Ballast for Metal Halide Lamps (HID)

Code	Rated Current	Lamp Wattage	Starting V	Size (mm)
SH35	0.18A	35W	3.5kV	123 x 78 x 30.5
SH70	0.36A	70W	4.5kV	123 x 78 x 30.5
SH150I	0.70A	150W	4.5kV	175.4 x 88 x 36
SH150*	0.70A	150W	4.5kV	175.4 x 88 x 36

\*For SH150 – Ballast with separate ignitor enables ballast placement 30m from lamps.  
 • Supply Voltage: 180-264VAC • Ambient temperature (ta) -15°C – +50°C & max. case temp. 75°C

## VS COMPONENTS

### Electronic T8 Ballast - Warm Start - 220-240VAC

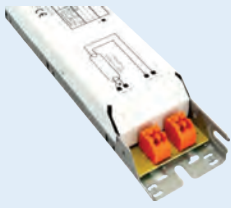

Code	Wattage	Type	Base	Size (mm)
188704	18W / 36W	T8	G13	230 x 41 x 28
188705	2 x 18W / 36W	T8	G13	230 x 41 x 28
188706	1 x 58W	T8	G13	230 x 41 x 28
188707	2 x 58W	T8	G13	230 x 41 x 28
188595	3 x 36W	T8	G13	230 x 41 x 28
188744	3 x 18W / 4 x 18W	T8	G13	230 x 41 x 28

### Electronic T5 Ballast - Warm Start - 220-240VAC



188921	1 x 14W / 1 x 21W / 1 x 28W / 1 x 35W	T5	G5	230 x 30 x 21
188094	2 x 14W / 2 x 21W / 2 x 28W / 2 x 35W	T5	G5	359 x 30 x 21
188438	3 x 14W / 4 x 14W	T5	G5	230 x 41 x 28
183112	3 x 28W	T5	G5	275 x 33 x 22
188142	1 x 54W	T5	G5	359 x 30 x 21
188618	2 x 54W	T5	G5	359 x 30 x 21
188144	1 x 80W	T5	G5	359 x 30 x 21
188619	2 x 80W	T5	G5	359 x 30 x 21

### Electronic ballast for multiple wattage CFL Lamps - 220 / 240VAC



Code	Wattage	Type	Base	Size
188700	18-40W	TC-DEL/TEL	2G10/2G11 2G x 13 G24q-3/Gx24q-3	103 x 67 X 31

### HPS / Metal Halide ballasts - 230 / 240VAC



Code	Wattage	Amps	Size LxBxH	Capacitor Required	Lamp Type
161367	35W	0.53A	108 x 66 x 53	6µF	HPS / MH
161379	50W	0.76A	108 x 66 x 53	8µF	HPS
571022	70W	0.98A	108 x 66 x 53	12µF	HPS / MH
570964	100W	1.20A	112 x 86 x 36	12µF	HPS / MH
571013	150W	1.8A	145 x 69 x 53	20µF	HPS / MH
504109	250W	3.00A	108 x 66 x 53	32µF	HPS / MH
178771	250W	3.00A	133 x 102 x 93	32µF	HPS / MH
571054	400W	4.45A	148 x 135 x 62	45µF	HPS / MH
533484	600W	6.20A	173 x 102 x 93	55µF	HPS
528548	1000W	10.3 / 9.5A	203 x 102 x 92	100 / 85µF	HPS / MH
554304	2000W	8.8A	160 x 150 x 128	37µF	MH
554306	2000W	10.3A	160 x 150 x 128	60µF	MH

### Mercury Vapour / Metal Halide Ballast - 230VAC



167304	80W	0.80A	108 x 66 x 53	8µF	MV
570969	125W	1.15A	112 x 86 x 36	10µF	MV
167367	250W	2.13A	145 x 66 x 53	18µF	MV / MH
570971	400W	3.25A	180 x 69 x 53	25µF	MV / MH
528761	1000W	7.50A	173 x 102 x 92	60µF	MV

### Igniters



35-400W

1000-2000W

Code	Wattage	Size LxBxH	Type	Pick V
140597	35-400W	78 x 34 x 27mm	Superimposed 3 Wire	4-5kV
140430	250-1000W	Ø50 x 80mm	Superimposed 3 Wire	4-5kV
140497	2000W	Ø50 x 98mm	Superimposed 3 Wire	4-5kV

### Standard Magnetic Ballast - 230VAC



Code	Output Wattage	Type	Base	Size (mm)
508183	18W	TC-F / TC-L	2G10 / 2G11 / 2G13	150 x 41 x 28
	18W / 20W	T8 / T12	G13	
529029	36W	TC-F / TC-L	2G10 / 2G11	150 x 41 x 28
	36W / 40W	T8 / T12	G13	
508186	58W	T-U	2G13	190 x 41 x 28
	58W / 65W	T8 / T12	G13	

## MAGNETIC BALLASTS



**Ballast for Mercury Vapour Lamps 230V 50Hz**

Code	Watts	Amps	Size (L x W x H)	Capacitor Required
<b>Q80-612.2</b>	80W	0.8A	112 x 66 x 53	8 $\mu$ F
<b>Q125-613.2</b>	125W	1.15A	112 x 66 x 53	12 $\mu$ F

For 250W & 400W, See **M250.2** and **M400.2** below.

**High Pressure Sodium (HPS) and Metal Halide (MH) Lamps 230V 50Hz**



Code	Watts	Amps	Size L x W x H	*Capacitor Required	For Lamp Type
<b>SM70.2</b>	70	1A	112 x 66 x 53	12 $\mu$ F	HPS/MH
<b>SM100.2</b>	100	1.2A	144 x 66 x 53	12 $\mu$ F	HPS
<b>SM150.2</b>	150	1.8A	144 x 66 x 53	20 $\mu$ F	HPS/MH
<b>SM250.2</b>	250	3.0A	180 x 66 x 53	32 $\mu$ F	HPS/MH
<b>SM400.2</b>	400	4.6A	133 x 102 x 92	50 $\mu$ F	HPS/MH

**For Metal Halide and Mercury Vapour Lamps**

<b>M250.2</b>	250	2.13A	144 x 66 x 53	18 $\mu$ F	MH/MV
<b>M400.2</b>	400	3.4A/3.25A	180 x 66 x 53	30 $\mu$ F	MH/MV
<b>B1000S</b>	1000	10.3A	203 x 102 x 92	100 $\mu$ F	HPS

**Ballast for Tubular or Compact Fluorescent Lamps 230V 50Hz.**



Code	Lamp	Watts	Size L x W x H
<b>FL20</b>	T8	18-26W	155 x 41 x 28mm
<b>FL40</b>	T8	1x36W or 2x18W	155 x 41 x 28mm
<b>FL65</b>	T8	58-65W	195 x 41 x 28mm
<b>FC9</b>	PL	7/9/11W	100 x 41 x 26mm
<b>CB-508</b>	PL	13/18W	95 x 41 x 28mm
<b>CB800-26</b>	PL	26W	155 x 41 x 28mm
<b>CB800-42</b>	PL	42W	155 x 41 x 28mm



**Electronic Ballast Lamp Holder**

<b>DEB-G182</b>	PLC, PLCE (G24q, GX24q)	9-18W	$\phi$ 40 x 50 mm
-----------------	-------------------------	-------	-------------------

**Ballast for PL-Lamp c/w Holder**



<b>CLB313</b>	PL		155 x 41 x 18mm
<b>CLB318</b>	PLC		155 x 41 x 18mm

**Control (Plastic) Box for PL-Lamp**



Code Magnetic	Watts	Size	Code Electronic
<b>CBP-213</b>	2 x 13W c/w 3.25MF cap	254 x 52 x 100mm	<b>EBP-214</b>
<b>CBP-218</b>	2 x 18W c/w 4MF cap	254 x 52 x 100mm	<b>EBP-218</b>
<b>CBP-226</b>	2 x 26W c/w 8MF cap	254 x 52 x 100mm	<b>EBP-226</b>

## IGNITOR / STARTERS

**Ignitors for High Pressure Sodium and Metal Halide Lamps 220-240V 50/60Hz**

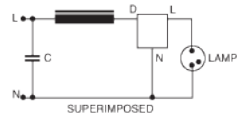

Code	Type	Watts	Pick V.	Amps	°C	Size L x $\phi$
<b>CD-7</b>	Superimposed 3 Wire	35-400	3-4.5kV	1.8	105	90 x 35mm
<b>CD-10</b>	Superimposed 3 Wire	600-1000	3-4.5kV	1.8	105	90 x 35mm

**Enclosed Control Gear C/w Ignitor, Capacitor and Ballast for HPS & MH**

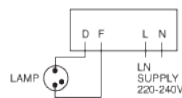

<b>UR70.20</b>	70	1	245 x 120 x 70mm
<b>UR100.20</b>	100	1.2	245 x 120 x 70mm
<b>UR150.20</b>	150	1.8	245 x 120 x 70mm
<b>NB150GB (for metal halide only)</b>	150	1.8	245 x 120 x 70mm

Report No. EMI/2316/Y1022A & B  
2330/YE1457A & B

**FST2 & 4**



**Linear Fluorescent Lamp Starters**

Code	Wattage	Voltage	Description
<b>FST2</b>	4-25W	220-240V	To be used with 2 x 18W Tube, single 40W ballast luminaire
<b>FST4</b>	4-85W	220-240V	For use with 3ft, 4ft and 5ft tubes

**NEW**

# EMERGENCY KIT WITH STANDBY FEATURE

Input Voltage: 230VAC

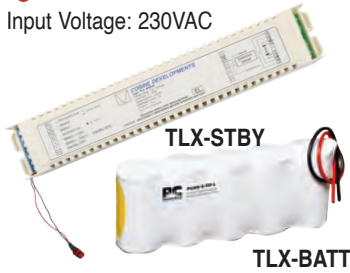

The Emergency Control unit has a standby inhibit function to conserve battery power during power failure I Maintained and Non-Maintained

**Emergency Kit with Standby Power** - Battery to be Ordered Separately

Code	Fluorecent Lamp Wattage	Emergency Duration	Dimensions (mm)
TLX-STBY	6 - 80W	20% 1hr	247 x 45 x 35

**Battery - Nickle-Cadmium**

Code	Battery Capacity	Voltage	Dimensions (mm)
TLX-BATT	5 x 2Ah	6V	110 x 46 x 26

**220-240V Electronic Emergency Inverters for use with Electromagnetic and Electronic Ballasts**



Code		Lamp		Size L x W x H	Spare Battery	Battery		Output Lumen
1H	3H	Type	Watts			Volts	Ah	
1A186018	3A186040	T8/T5/G23	18-65W	190x40x35	5KRH23/43	6V	4	38%-10%
-	RP0701	G24/Gx24/G2G11	18-65W	175x41x35	802027	3.6V	4	38%-10%

\*Automatically cycles the battery every 4 weeks. Includes battery and LED battery indicator. Provides power to all fluorecent lamps during power failure to provide a suitable level of illumination for evacuation. Can be used for maintained and non-maintained illumination conversions.

**Emergency Lighting Modules for TC and T Lamps** - 6 to 80W with Self-Diagnosis function I Battery charging Time 24h I Designed for installation in LED Luminaires for Safety Lighting for rescue routes and Extremely hazardous work places

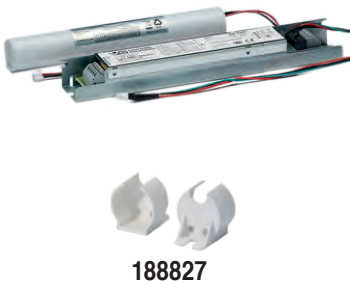

Code		Lamp		Size L x W	NiCd Battery	Battery		Output Lumens
1H	3H	TYPE	Watts			Volts	Ah	
188792	-	TC&T	6-80W	190 x 23	188827	4.8V	1.8Ah	3.7-43%
-	-	TC&T	6-80W	240 x 33	188828	4.8V	4.5Ah	3.7-43%

**Accessories**

Code	Description
188827	Holder for 1H Rechargeable Batteries
188828	Holder for 2H Rechargeable Batteries

**220-240V Combined Electronic Ballast and Emergency Inverter**



Code		Lamp		Output Lumen	Size L x W x H	Spare Battery					
1H	3H	Type	Watts			1H		3H			
						V	Ah	V	Ah	V	Ah
DT-18E-1H	DT-18E-3H	T8	18W	38%	288x30x40	3KRH23/43	3.6	1.8	3KRH33/62	3.6	4
IT-36E-1H	IT-36E-3H	T8	36W	18%	425x30x38	4KRH23/43	4.8	1.8	4KRH33/62	4.8	4
IT-58E-1H	IT-58E-3H	T8	58W	10%	425x30x38	5KRH23/43	6	1.8	5KRH33/62	6	4
IT-54E-1H	IT-54E-3H	T5	54W	10%	425x30x38	5KRH23/43	6	1.8	5KRH33/62	6	4

**220-240V Emergency Inverters for PL 26W lamps**

Code	Description
HT-PL26W	3 hour emergency duration kit for PL26W lamp (single lamp)

**NEW**

# LED EMERGENCY DRIVER

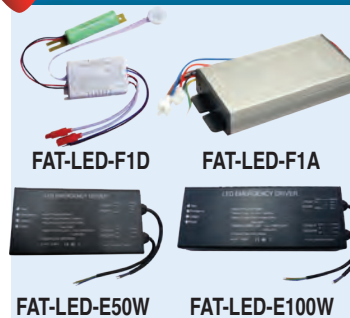

**Universal LED Driver**

Input Voltage: 85-265V I Battery Cycle Times  $\geq 500$  I To be used with External LED Driver

Code	Emergency Luminous Flux	LED Lamp Power	Output	Battery	Emergency	Size (mm)
FAT-LED-F1D	2-4W	3-20W	To driver	18650 Li-ion 3.7V; 2200mAh	3 hours	68 x 38 x 20
FAT-LED-F1A	4W Fixed	3-40W	To driver	18650 Li-ion 3.7V; 2400mAh	$\geq 2$ hours	110 x 55 x 21
FAT-LED-E50W	100%	3-50W	230VAC	18650 Li-ion 18.5V; 5200mAh	$\geq 90$ min	230 x 105 x 50
FAT-LED-E100W	100%	50-100W	230VAC	18650 Li-ion 18.5V; 7200mAh	$\geq 90$ min	310 x 105 x 50

**Emergency Inverter**

Input Voltage: 230VAC I Maintained & Non-Maintained I Not limited to a specific number of cells for a given inverter I Battery not included I Compatable with **IBG-LED-60W** & **IBG-LED-100W** (page 49)

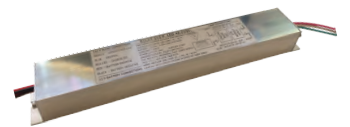

Code	Nominal Voltage	Nominal Current	Lamp Power	Battery	Emergency Time	Size (mm)
ECLAT-39410	24VDC	2950mA	60-70W	18V (3x6V 4.5Ah)	1hr 100%	31 x 40 x 280
ECLAT-39482	24VDC	2500mA	90-120W	24V (4x6V 4.5Ah)	1hr 100%	31 x 40 x 280

2 Year warranty on all LED products, unless otherwise specified. Warranty void if adequate surge protection is not installed on LED products. See page 147

**EMERGENCY ILLUMINATION**



**LED Slim Light - Maintained / Non-Maintained** (Jumper Selectable) - **IP20** | 230 VAC

Codes	Consumption	Battery Ni-Cd	Duration	Lamp	Light Output	Weight
<b>GR-8/12LED</b>	3VA	3.6V / 0.6Ah	1.5hrs	12 LED's	35lm / 85lm	430g
<b>GR-9/12LED</b>	3.5VA	3.6V / 1Ah	3hrs	12 LED's	32lm / 85lm	460g

• Size (mm): 246(L) x 76(W) x 45(D)

**Additional Self-Adhesive Legends** - To be ordered separately



S-00800/S65L

S-00800/S65R

S-00800/S65D

Self-adhesive legends included in pack. Suitable for each direction.



**Professional Light**



**LED**



**A-1013**

**Professional Light - Emergency Luminaires 230V IP20**

Code	Consumption	Battery Ni-Cd	Duration	Lamp	Light Output	Weight
<b>Fluorescent - Non-Maintained</b>						
<b>GR-110</b>	3VA	2.4V / 1.5Ah	90min	8W	85lm	770g
<b>GR-112</b>	3VA	2.4V / 3Ah	3hrs	8W	85lm	870g
<b>GR112-2</b>	3VA	2.4V / 3Ah	3hrs	2 x 8W	85lm	870g

**Fluorescent - Maintained**

<b>GR-115</b>	23VA	2.4V / 1.5Ah	90min	8W	315 / 85lm	810g
<b>GR-116</b>	24VA	2.4V / 3Ah	3hrs	8W	315 / 85lm	920g

**LED - Maintained & Non-Maintained** (Jumper Selectable)

<b>GR-110-LED</b>	3VA	3.6V / 600mAh	90min	3W LED	105lm	590g
<b>GR-112-LED</b>	3VA	3.6V / 1.5Ah	3hrs	3W LED	105lm	670g

- c/w Easy Base - for easy installation
- Spare Lamp **FLT5-8**

**Accessories**

Code	Description
<b>A-1013</b>	Recess mounting base for wall or suspended ceiling installation

**Additional Self-Adhesive Legends** - To be ordered separately



Self-adhesive legends included in pack. Suitable for each direction.



S-11100/S65L



S-11100/S65R



S-11100/S65D

**Double Easy Light - Emergency Luminaires 230V IP42**

Code	Consumption	Battery Ni-Cd	Duration	Lamp	Light Output	Weight
<b>Fluorescent - Non-Maintained</b>						
<b>GR-380</b>	3VA	2.4V / 1.5Ah	90min	8W	85lm	900g
<b>GR-382</b>	4VA	2.4V / 3Ah	3hrs	8W	85lm	1000g

**LED - Non-Maintained**

<b>GR-391/L</b>	3VA	3.6V / 1.5Ah	1.5hrs	3W	220lm	900g
<b>GR-393/L</b>	3VA	3.6V / 3Ah	3hrs	4.3W	220lm	1000g

- Dimensions: 350(L) x 134(W) x 60(H)mm
- Can be mounted onto the ceiling or wall, using special mounting accessories, which are included.
- Spare Lamp **FLT5-8**

**Additional Self-Adhesive Legends** - To be ordered separately



Self-adhesive legends included in pack. Suitable for each direction.



S-31100/S65L



S-31100/S65R



S-31100/S65D

## EMERGENCY ILLUMINATION

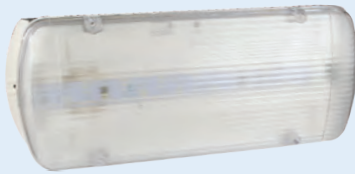

### LED Weather Light - Emergency Luminaire - Non-Maintained - IP65 | 230V

Codes	Consumption	Battery Ni-Cd	Duration	Lamp	Light Output	Weight
GR-1935/15L	3VA	3.6V / 600mAh	1.5hrs	2.5W	105lm	1010g
GR-1936/15L	4VA	3.6V / 1.5Ah	3hrs	2.5W	105lm	1080g

• Dimensions: 363(L) x 145(W) x 73(H)mm

#### Additional Self-Adhesive Legends - To be ordered separately



S-93593/S65L



S-93593/S65R



S-93593/S65D

### Eco Light - Emergency Luminaire - 230V IP42

Codes	Consumption	Battery Ni-Cd	Duration	Lamp	Light Output	Weight
<b>LED - Maintained Edge Illumination with Green LEDs &amp; Transparent Background</b>						
MLD28/G	7.5VA	3.6/1Ah	3hrs	8 LEDs	18/18lm	500g
MLD34/G	8VA	3.6/1Ah	3hrs	11 LEDs	18/22lm	800g
MLD44/G	8VA	3.6/1Ah	3hrs	13 LEDs	18/22lm	1200g

#### LED - Maintained Edge Illumination with White LEDs & Green Background

MLD28/W	7.5VA	3.6/1Ah	3hrs	8 LEDs	45/45lm	520g
MLD34/W	8VA	3.6/1Ah	3hrs	11 LEDs	45/55lm	860g
MLD44/W	8VA	3.6/1Ah	3hrs	13 LEDs	45/55lm	1250g

#### Dimensions

MLD28	280(L) x 100(H) x 75(W)mm
MLD34	340(L) x 170(H) x 75(W)mm
MLD44	440(L) x 220(H) x 75(W)mm

#### Accessories included:



• Includes 2 pairs of special PVC Overlays



#### Accessories

A-1022	Rigid arms for ceiling installation; 20cm distance
A-1025	Rigid arms for ceiling installation; 40cm distance
A-1026	Rigid arms for ceiling installation; 60cm distance
A-1027	Chains for ceiling installation; 50cm
A-1021	Recess mounting base for MLD44

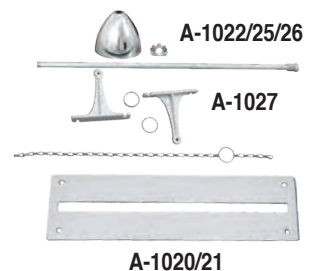

Hanging Installation using the special mounting sets.

A-1022 - suitable for 20cm distance

A-1025 - suitable for 40cm distance

A-1026 - suitable for 60cm distance



Recessed Mounted Installation on suspended ceiling using the base type A1020, A-1021

### Wall Mount Exit Emergency Light - 230V IP65

Codes	Power	Battery Ni-Cd	Duration	Size (mm)	Auto Switch On Power Failure
DL-623	*2 x 8W	2.4V/4.5AH	3hrs	380(L)x160(W)x90(H)	Yes

\* Two Tubes for mains

• One Tube for emergency

• Includes 1 x EXIT PVC internal fitted label (DL-5) and battery c/w internal charger

#### Accessories

SY640	Spare 6V/4AH Battery
FLT5-8	Spare 8W Fluorescent Lamp



DL-623 c/w Exit Sign



DL-5



DL-6



DL-7



## EMERGENCY ILLUMINATION



**LED Non Maintained - Ceiling Mounted IP42** - Input Voltage: 230VAC | Deep Discharge and Overcharge Protection | 24hrs Charge Time | Each device must be permanently connected to mains power supply. In normal operation the battery is charging. In case of a mains power failure the device will light the illumination LED automatically in emergency mode. When power is restored the device turns to normal operation

Codes	Wattage	Battery Ni-CD	Duration	Lamp	Lumens	Weight	Size (mm)
GR-471	24W	36V/1.2Ah	1.5h	2W	160lm	470g	195 x 195 x 60



**LED Recessed Emergency Downlight IP20** - Input Voltage 230VAC | Battery: 3.7V 3Ah 18650 | Charge Time 12h | Built-in Test Function | 160° Beam Angle | Non-Maintained | Applications: Hotels, Restaurants, Shopping Malls, Offices, & Public Places to provide Illumination for Evacuation

Code	Wattage	Lumens	Duration	Size (mm)
JH-396B-3W*	3W	180lm	≥3hrs	Ø60 x 26.5mm

\*Add colour temp. to code: ○ WW (3000K), ○ CW (4200K)

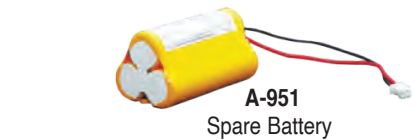

**LED Downlight Emergency Kit - 230V**

Codes	Consumption		Battery Ni-Cd	Duration		Lumen
	1 Spot	4 Spot		1 Spot	4 Spot	

**Non-Maintained Converter with battery**

GR-76	4VA	28VA	3.6V / 1Ah	3hrs	45min	100 / 50lm
-------	-----	------	------------	------	-------	------------

**LED Downlight**

GR-83 LED	1.5VA	-	-	40lm
-----------	-------	---	---	------



GR-76



GR-83 LED



- Dimensions: 82 x 82 x 29mm
- To fit standard 3" x 3" box (75 x 75mm)



**LED "Weatherproof Spotlight" - Emergency Luminaires IP65**

Codes	Voltage	Consumption	Light Source	Light Output
-------	---------	-------------	--------------	--------------

**LED - Non-Maintained**

GR-80	230VAC	6VA	9 LEDs	30lm
GR-81	12V AC/DC	100 / 60mA	9 LEDs	30lm

• Flush mounting in junction box or plaster board.

## STEEL LED EMERGENCY EXIT SIGNS

**Steel LED Emergency Exit Signs** - Input Voltage: 230VAC | Self Contained | Surface Mount



LED-EXIT-1



LED-EXIT-2













LED-EXIT-3

Codes	LED Wattage	Emergency Time	Battery Type	Size (mm)
LED-EXIT-1	2W	2hrs	Ni-Cad	375 x 25 x 147
LED-EXIT-2	2W	2hrs	Ni-Cad	375 x 25 x 147
LED-EXIT-3	3W	3hrs	Ni-Cad	430 x 45 x 215







## EMERGENCY ILLUMINATION

		<b>Wall Mount</b> 	<b>Double Sided</b> c/w 25cm chains 	<b>Legends</b>  - RIGHT  - LEFT  - DOWN  - EXIT
<b>Code</b> Non-Maintained	<b>LED808NM</b>	<b>LED308SNM</b>	-	
<b>Code</b> Maintained	<b>LED808M</b>	<b>LED308SM</b>	<b>KE328</b>	
Lamp	0.9W	0.9W	0.7W	
Mounting	Recessed ceiling mount	Wall Mount	Ceiling Mount	
Material	Sheet Steel & Polycarbonate	Sheet Steel & Polycarbonate	Aluminium & Acrylate Plastic	
Battery	3.6V 900mAh > 3hrs	3.6V 900mAh > 3hrs	Ni-Cd 3.6V 350mAh > 3hrs	
Size (mm)	410 x 140 x 240	392 x 190 x 61	370 x 52 x 500	
<b>Legends</b>				
Exit	<b>KEX808-EXIT</b>	<b>KE308S-EXIT</b>	-	
Down	<b>KEX808-DOWN</b>	-	<b>KE328-DOWN</b>	
Left	-	<b>KE308S-LEFT</b>	<b>KE328-L/R</b>	
Right	-	<b>KE308S-RIGHT</b>	<b>KE328-L/R</b>	
			<b>Bulk Head IP65</b> 	<b>IP65</b> 
<b>Code</b> Non-Maintained	-	-	-	<b>KE108/LED/NM</b>
<b>Code</b> Maintained	<b>KES112LED</b>	<b>KE338</b>	<b>KEM2D28W</b>	<b>KE108/LED/M</b>
Lamp	0.7W	0.9W	16W	3W
Mounting	Recessed Ceiling Mount	Ceiling Mount	Wall or Ceiling Mount	Wall or Ceiling Mount
Material	Aluminium & Acrylate Plastic	Aluminium & Acrylate Plastic	Polycarbonate Plastic	Polycarbonate Base & Diffuser
Battery	3.6V 900mAh > 3hrs	3.6V 900mAh > 3hrs	3.6V 4.5Ah > 3 hrs	3.6V 1.5Ah
Size (mm)	65 x 340 x 470	400 x 52 x 530	Ø320 x 115	352 x 102 x 72
<b>Legends</b>				
Exit	<b>KES112LED-EXIT</b>	<b>KE338-EXIT</b>	-	-
Down	-	<b>KE338-DOWN</b>	-	-
Left	<b>KES112LED-L/R</b>	<b>KE338-L/R</b>	-	-
Right	<b>KES112LED-L/R</b>	<b>KE338-L/R</b>	-	-

Maintained: When mains power is on the light is on. When mains fails the light stays on Non-Maintained: When mains power is on the light is off. When mains fails the light comes on.

### LED EMERGENCY LAMPS

### LED EMERGENCY FLOOD

 <b>AS-8221</b>	 <b>AS-8222</b>	<b>Rechargeable LED Lamps</b> - Lamp can be operated from the mains or from the built in battery   Charge time: 4hrs   Battery life: 4hrs when fully charged   Automatic emergency illumination function   Supplied with a lampholder adaptor so that the lamp can be used in Bayonet or screw-in fittings	<ul style="list-style-type: none"> <li>c/w 7Ah battery for emergency standby</li> <li>3hrs working time On Power Failure on fully charged battery</li> </ul>		
<b>Code</b>	<b>Description</b>	<b>Code</b>	<b>JM-EMG-54W-*</b>	<b>GY480EMG-MT-100W-*</b>	
<b>AS-8221</b>	LED emergency lamp c/w E27 lampholder adaptor and ON/OFF remote	<b>Watts</b>	40W	100W	
<b>AS-8222</b>	LED emergency lamp c/w E27 lampholder adaptor	<b>Lumen</b>	4000lm	9000lm @ Full Power	
		<b>Size (mm)</b>	315 x 235 x 125	350 x 300 x 70	
			*Add colour to code: ○ CW (Cool White), ○ WW (Warm White).		

2 Year warranty on all LED products, unless otherwise specified. Warranty void if adequate surge protection is not installed on LED products. See page 147

## RECHARGEABLE A60 LED LAMP

**EMG-A60**  
3W, 5W, 9W

**EMG-A60-12W**
**EMG-SMD-GU10-3W**

**EMG-SMD-GU10-5W**
**LED A60 Emergency Lamp - Working Time: 4 - 5 Hours**

Code	Wattage	Lumens	Size	Base
<b>EMG-A60-3W-CW</b>	3W	225lm	60 x 108mm	E27 with B22 Adaptor
<b>EMG-A60-5W-*</b>	5W	375lm		
<b>EMG-A60-9W-*</b>	9W	675lm		
<b>EMG-A60-12W-*</b>	12W	900lm	80 x 170mm	

**LED GU10 Emergency Lamp - Working Time: 2-3 Hours**

Code	Wattage	Lumens	Size	Base
<b>EMG-SMD-GU10-3W-*</b>	3W	190lm Normal 85lm Emergency	Ø50 x 55	GU10
<b>EMG-SMD-GU10-5W-*</b>	5W	350lm Normal 120lm Emergency	Ø50 x 80	GU10

\*Add colour to code: ○ **CW** (Cool White), ○ **WW** (Warm White), ○ **DL** (Daylight)

## LED EMERGENCY LIGHT FITTINGS IP40

**LED Emergency Lamps for Domestic Use**

- Supply Volts 230VAC
- Complete with battery charger
- Charging Time: 24 hours
- Perfect for use as a portable work lamp.

**RWELEDJ-1**
**RWELEDJ-2**
**NS350LX**
**NS650LX**
**LED008**
**AL-2166**
**AL-3600**

Code	Lumen	Battery	Discharge Time	Size (mm)
<b>RWELEDJ-1</b>	102-153lm	5hrs	6VDC	408 x 85 x 76
<b>RWELEDJ-2</b>	38.4-1.2lm	5hrs	6VDC	340 x 75 x 75
<b>NS350LX</b>	300-350lm	4hrs	3.7V 1200mAh	220 x 65 x 40
<b>NS650LX</b>	270lm	4hrs	4VDC	395 x 60 x 44
<b>LED008</b>	98+220lm	3.7V 2200 mAh	8hrs single LED 4hrs multiple LEDs	220 x 77 x 120
<b>AL-2166</b>	360lm	3.7V 1,8Ah Li-ion	Max Power up to 1.5hrs Low Power up to 10hrs	325 x 55 x 30
<b>AL-3600</b>	360lm	3.7V 1,2Ah Li-ion	Low - 8 hrs, High - 4hrs	392 x 58 x 43

**EMERGENCY**
**LIGHTING**

**LED Emergency Twin Spot IP65 - Automatic operation | Built-in charger |**

Back-up time: &gt; 3hrs

Code	Supply	Battery	Lamps	Size (mm)
<b>KE448LED-NM</b>	230VAC	3.6V 6Ah	2 x 6W	305 x 305 x 76

**Ceiling Mount Exit Emergency Light IP20**

230V Both side indicator

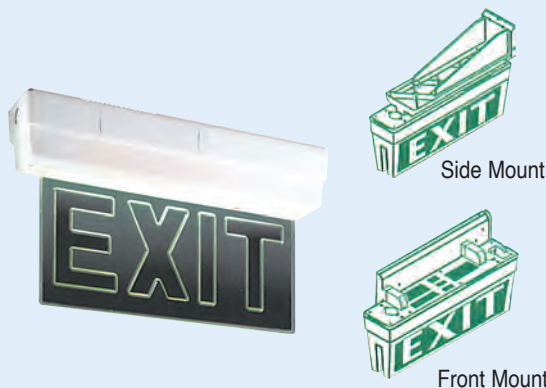

Side Mount

Front Mount

Codes	Power	Battery Ni-Cd	Duration	Size (mm)	Auto Switch On Power Failure
<b>DL-758S</b>	1 x 8W	6V/1.2AH	1.5hrs	410 x 90 x 160	Yes

\*1st Tube for permanent light, 2nd Tube for emergency light.

Include battery c/w internal charger

**DL-1**
**DL-2**
**DL-3**

NEW

## CHICKEN FARM LIGHTING SYSTEM



AMB-IDS



WP4A



AMB-PE



AMB-TC



AMB-ME

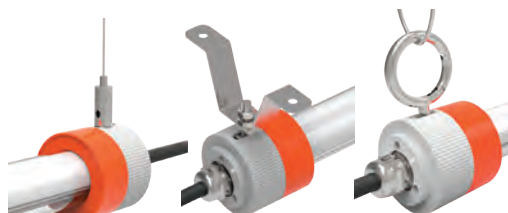

AMB-SK

AMB-CM

AMB-RM



BE27

**Programmable Dimmer & Timer IP66** - Input Voltage: 230VAC | Support DIY Programming | Master / Slave Function, supports both Triac & 0-10V Dimming. "Master Function" - Control dimming from the unit, "Slave Function" - Use central 0-10V control system dimming. | Leading Edge & Trailing Edge | 0%-100% Dimmable, dimming precision 1% | 7 inch LCD | Easy replacement for traditional lamps, no need to rewire the existing cable installation.

Code	Output Current	Max Watts
AMB-IDS-2000W	1 x 10A	2000W
AMB-IDS-4000W	2 x 10A	4000W

**A Series - T8 Triac Dimmable IP66** - Input Voltage: 230VAC | Double V-Shape 150° Viewing Angle | CRI > 80 | L80B50 70 000hrs | **Full spectrum** | Dimming from 0.2% - 100% without flicker to simulate sunrise to sunset | 300mm male and female connector for series connection | Anti-ammonic and acid for poultry industrial lighting | To be used with **AMB-IDS** controller

Code Triac	Wattage	Lumens	Length (mm)
WP4A-T8-20W-D-*	20W	2000lm	1200 x 28

\* Add Colour Temperature to Code: ○WW (3000K), ○CW (4200K), ○DL (5000K)

**A Series - T8 0-10V Dimmable IP66** - Input Voltage: 230VAC | V-Shape 150° Viewing Angle | CRI > 80 | L80B50 70 000hrs | **Full spectrum** | Dimming from 3% - 100% without flicker to simulate sunrise to sunset | 300mm male and female connector | Anti-ammonic and acid for poultry industrial lighting | Compatible with any 0-10V Control System

Code 0-10V	Wattage	Lumens	Length (mm)
WP4E-T8-20WH-D-*	20W	2000lm	1200 x 28

\* Add Colour Temperature to Code: ○WW (3000K), ○CW (4200K), ○DL (5000K)

### Accessories

Code Triac	Description	Code 0-10V	Description
AMB-PE	1m Power Extension	WP4E-PE	1m Power Extension
AMB-ME	4m Middle Extension	WP4E-ME	4m Middle Extension
AMB-TC	"T" Connector	WP4E-TC	"T" Connector
AMB-M15	15m Extension from Controller	WP4E-M15	15m Extension from Controller
AMB-EC	End Cap	AMB-EC	End Cap

### Mounting Accessories

Code	Description
AMB-SK	Suspended Mounting Kit (Complete for 1 Tube)
AMB-CM	Ceiling Mounting Kit (Complete for 1 Tube)
AMB-RM	Ring Mounting kit (Complete for 1 Tube)

**Poultry Farm LED Lamp IP65** - | Input Voltage: 230VAC | Dimmable 0 - 100% | Beam Angle: 220° | Working Temperature: -20° to 50° | Alumite treated to protect against corrosion.

Code	Wattage	Lumens	Size (mm)
BE27-7W-*	7W	700lm	Ø43 x 158
BE27-12W-*	12W	1200lm	Ø49 x 179

\* Add Colour Temperature to Code: ○WW (3000K), ○CW (4200K), ○DL (5000K)

NEW

## LED LOW BAY PLANT GROW SYSTEM



**LED Plant Grow Bay IP65** - Input Voltage 85-305V | Dimmable 0-10V | 120° Beam Angle | Full spectrum 3000K+6500K+660nm+IR730nm | Uniform Light Coverage | Applications: Greenhouse, Hydroponics, Multiculture, Aeroponics, Garden or grow tent

Code	FU-BLX-320	FU-BLX-640
Wattage	320W	640W
Lumens	6867lm	12578lm
Ratio	White+660nm+730nm	White+660nm+730nm
PPF	2.8 - 3.2 umol/J	2.8 - 3.2 umol/J
LED Qty	960pcs	960pcs
Size (mm)	1200 x 600 x 80mm	1200 x 600 x 80mm

# LED LOW BAY PLANT GROW SYSTEM



Code	H158D-140W	H161D-280W	H162-350W	Spares	
Input Voltage	100-240VAC	100-240VAC	100-240VAC	<b>Code</b>	<b>Description</b>
Output Power	140W	280W	350W	<b>H4-MOD-35W</b>	Spare light module 35W
Lumens	5180lm	10563lm	13204lm	<b>H4-DRV-70W</b>	Spare LED Driver (one driver drives 2 light modules)
Size (mm)	280 x 280 x 70H	540 x 280 x 70H	670 x 280 x 70H		

**Features** • Easy maintenance: Modular system • Air circulation system design - to obtain the ideal CO<sub>2</sub>/O<sub>2</sub> ratio considerably improving plant growth • Self testing function - when indicator light is on, the light module is faulty and needs to be changed.

## LED PLANT GROW LIGHTS



**T8 Plant Growing SMD LED Tubes** - Input Voltage: 85-265VAC | Plant grow lamps have LED's that produce light in Blue (450nm) and Red (660nm) wavelengths that are ideal for promoting photo-biological processes in plants. These lamps can be used wherever plants do not receive enough natural light or in agricultural applications.

Code	Length	Power	Replaces T8 Lamp
<b>LEDT8PG-A2FR</b>	600mm	9W	18W (2FT)
<b>LEDT8PG-A3FR</b>	900mm	15W	30W (3FT)
<b>LEDT8PG-A4FR</b>	1200mm	18W	36W (4FT)
<b>LEDT8PG-A5FR</b>	1500mm	22W	58W (5FT)



**LED PAR38 Plant Grow Lamp - IP65**

Code	Base	Watts	Lumen
<b>LED-PAR38-12W-PG</b>	E27	12W	171lm

- 75% Red, 25% Blue
- The wave length for red is 662nm, for blue is 447nm

NEW



**A60 LED Filament Plant Grow Lamp E27** - Input Voltage: 220 - 240VAC | Dimensions: Ø60 x 108mm | Full Colour Spectrum for general use | Ideal for greenhouse glass or plastic, Planting factory, Hydroponic shelves, Home Planting.

Code	Wattage	Colour Spectrum	PPF (400-700nm)	PAR Watt (W) (400-700nm)	PPF (400-700nm)
<b>XGY-A60-8-E27</b>	8W	Full Spectrum	>12 µ mol	0.3 - 0.5mW	>1.5 µ mol/s/W

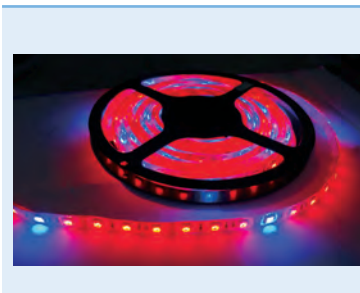

**LED Plant Grow Strips IP65** - Supplied with 230VAC Power Adaptor | LED Strip 24VDC Lumens: 10-22lm | Viewing Angle: 120° | Blue (Wave Length: 455-465nm) - Good for Photosynthesis. | Red (Wave Length: 660-665nm) - Peak Wavelength for Photosynthesis & Photoperiodism - Good for Blooming & Fruits | Red/Blue in one Chip: Red:Blue = 5:1 (Suitable for most Plant Growing)

Code	Description	No. LEDs	Max Power/m	Length
<b>HH-SRB60W</b>	Red/Blue 5:1	60lm	14W/m	10m
<b>HH-SRB120W</b>	Red/Blue 5:1	120lm	28W/m	10m
<b>HH-SR-60W</b>	Red	60lm	14W/m	10m
<b>HH-SB-60W</b>	Blue	60lm	14W/m	10m



**LED Plant Grow Floodlight IP65** - Input Voltage: 230VAC | Beam Angle 120° | Red<sup>16</sup> & Blue<sup>4</sup> | Wavelength: Red 630-660nm, Blue 400-470nm

Code	Wattage	Lumens	Size (mm)
<b>PG-GY225TG-20W</b>	20W	1300lm	200 x 180 x 45

SPECIALIZED

LIGHTING



**Clamp Grow Lights IP44** - Input Voltage: 85-265VAC | Lamp Life 50 000hrs | 360° Adjustable Head | Easy Mounting System

Code	No. of Heads	Wattage	Red : Blue : White	Goose Neck Size (mm)
<b>CGL-15</b>	1	1 x 12W	5 : 4 : 3	Ø95 x 495
<b>CGL-30</b>	2	2 x 12W	5 : 4 : 3	Ø95 x 495

PPFD per Head: 579 µmol @ 200mm / 434 µmol @ 300mm  
Coverage per Head: 400 x 400 @ 300mm / 500 x 500 @ 400mm

## LED UVC LIGHTS

NEW



**UVC Ultraviolet LED Cabinet Light IP20** - Input Voltage: 5VDC USB Rechargeable  
Wavelength 270-280nm | UV Sterilization & General Lighting | 140° Beam Angle | Built in motion sensor, when movement is detected Sterilization mode turns to daylight 6000k mode.

Code	Wattage	Spectrum	Size (mm)
DL-UVC-BAR-150	0.6W	White + UVC	150 x 36 x 17
DL-UVC-BAR-300	2W	White + UVC	300 x 36 x 17



**UVC LED Germicidal Light IP20** - Input Voltage: 230VAC | Wavelength 275+360nm  
| UV Sterilization | 140° Beam Angle | Aluminium + PC | Applications: Kitchen, Wardrobe, Closets & Cupboards | 30min for daily disinfection, 60min. Kills most bacteria and other micro-organisms.

Code	Wattage	Spectrum	Size (mm)
KS-UVC-A4W	4W	UVC	300 x 28 x 14
KS-UVC-A8W	8W	UVC	600 x 28 x 14
KS-UVC-A16W	16W	UVC	1200 x 28 x 14



**Hand-held UVC Light IP20** Input Voltage: 12VDC Rechargeable | Wavelength 240-280nm | Aluminium | Portable Handheld Device | Ideal for Travel

Code	Wattage	Spectrum	Size (mm)
UL-UVC-PT-01	1.8W	UVC	350 x 40 x 35



**Antibacterial LED Panel IP65** - Input Voltage: 230VAC | 120° Beam Angle | Aluminium + PMMA | Low Glare <19 | Dust and Waterproof | Applications: Hospital, Clean Room, Pharmaceutical Factory, Operating Room, Food Facilities. | A particular photocatalytic coating on the LED panel light ensures that bacteria and viruses that come in contact with the surface of the panel for a short period of time can be rendered harmless.

Code	Wattage	Lumens	Size (mm)
ABPC-6060-36-*	36W	3600lm	595 x 595

\*Add colour to code: ○ CW (Cool White 4200K), ○ DL (Daylight 6000K)

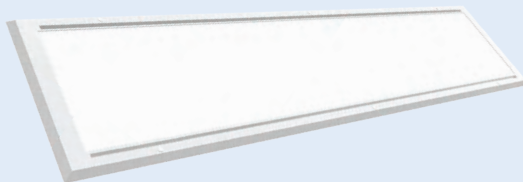

**Germicidal Surface Mount LED Panel IP44** - Input Voltage: 230VAC | 120° Beam Angle | Antistatic treated to avoid dust build up | Two function wall switch control sterilization and illumination, mode 1. Cool white (4000K) with no harmful UVC or blue light in spectrum, mode 2. UVC germicidal action, UVC: 270-280nm | Ideal for hospital, pharmaceutical, clean room, laboratories and food produce factories.

Code	Wattage	Lumens	Spectrum	Size (mm)
DFL-UVC-6060-40	40W+20W	4000lm	UVC	620 x 620 x 12
DFL-UVC-1203-40	40W+20W	4000lm	UVC	1220 x 320 x 12



**360° UV Disinfection Lamp** - Input Voltage: 230 | Irridation Area 50m<sup>2</sup> | UV Startup Delay 10s | Quartz Ultraviolet Lamp | Rated 10000hrs | U-Tube 340mm | All metal Lamp Holder | c/w Remote | Wavelength UV 253.7nm, Ozone 185nm

Code	Wattage	Spectrum	Size (mm)
PTX-003-WH	38W	UVC+Ozone	210 x 210 x 470



**T8 UVC LED Tube** - Input Voltage: 85-265VAC | 120° Beam Angle | Wavelength Range 270-280nm | Peak Wavelength 275nm | Radiant Flux max 5mW | Ceramic Substrate and Quarts Glass | Highly effective against inactivating and destroying the DNA of micro organisms found in mould, germs, bacteria and viruses.

Code	Wattage	Spectrum	Size (mm)
LEDT8-UVC-A2	9W	UVC	600 (2ft)
LEDT8-UVC-A4	15W	UVC	1200 (4ft)
LEDT8-UVC-A5	20W	UVC	1500 (5ft)

**NEW**

# PARKING BAY LIGHTING IP65

**Ultra Sonic Parking Bay Linear Light** - Input Voltage: 85-265VAC | Aluminium + PC |  
The luminaire uses an ultra sonic sensor to detect the presence of a vehicle | Installation height: 2-10m

Code	Application	Lumens	Power	Dimensions (mm)
PB-600-1	1 Bay	20W	2000lm @ Full Power	600 x 48 x 48
PB-2000-2	2 Bays	40W	4000lm @ Full Power	2000 x 48 x 48

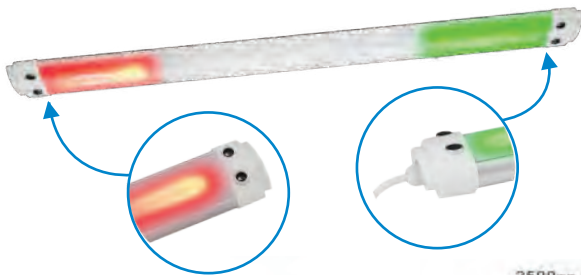

Vehicle not present, the luminaire will be partly green and dim down to 30%

Vehicle present, the luminaire will turn partly red and will brighten up to full power for 180sec then dim down to 30% light output

**NEW**

# WORK LIGHTS

IP67		LED	IP67 with magnet		LED	Magnet & 360° Flexible Hook		LED	<b>NEW</b>	360° Rotation Hook Magnetic Base		LED
<b>Code</b>	<b>SJ-2678</b>			<b>SP-W814</b>			<b>SP-WL47B</b>				<b>SP-WL14ARC</b>	
Lamp	60 LEDs			1 LED Top + 3W COB Inside			3W				1W + 3W COB	
Lumen	150lm			300lm			300lm				70lm - 120lm	
Power Supply	240V Adaptor & 12VDC Car lighter charger Rechargeable NiMh			3.7V 1800mAh Rechargeable 18650 Li-ion Battery			3 x AA (Incl)				3.7V 1800mAh Li-ion USB	
Battery Life	5-6hrs			3hrs			-				-	

	165mmØ	125mmØ			230VAC	230VAC	12VDC	230VAC
<b>Code</b>	<b>HL-13</b>	<b>AWL-009</b>	<b>JLM8933</b>	<b>SP-001</b>	<b>AWL-006</b>	<b>LK608007</b>	<b>AWL-006-DC</b>	<b>SP-JK1115</b>
Power	1 million/0.5 million Candle Power		2 million Candle Power	20W LED (2000lm)	60W max (E27)	60W max (E27)	60W max (E27)	100W max (E27)
Lamp	12V 55W		12V 100W	-	-	-	-	-
Spare Lamp	<b>H3-55-12VDC</b>		<b>H3-100W-12VDC</b>	-	-	-	-	-
Description	6" Spotlight c/w car lighter plug		6" Spotlight c/w car lighter plug	Material: PC + ABS, 5m Lead Top Hook & Handle Hook	Auto Lamp c/w 3m cable	Metal frame with rubber protection c/w 3m cable	Connects into car lighter	Auto Lamp c/w 3m Cable

















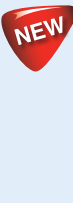







**PORTABLE  
SPECIALIZED**
**LIGHTING**

# WORK LIGHTS

	3-in-1 Torch / Lantern / Powerbank	2-in-1 Torch / Lantern	Floodlight / Spotlight Mode Emergency Flash IP44
	<p>c/w Charging Adaptor 1 x USB 5VDC/500mA 2 x 4VDC for Lamps</p> <p><b>LED</b></p> <p>Side View Back View</p>	<p>c/w Built in Charger</p> <p><b>LED</b></p> <p>Side view</p>	<p><b>LED</b></p>
<b>Code</b>	<b>YJ-2886</b>	<b>YJ-2829</b>	<b>KB8201</b>
<b>Wattage</b>	1 x 5W + 22 SMD	1 x 5W + 25 SMD	10W
<b>Lumens</b>	550lm	550lm	700lm
<b>Batteries</b>	2 x 2200MAH	6000MAH	3.7V 2400mAh
<b>Rechargeable</b>	Yes	Yes	ACDC or 12VDC Car Adaptor / USB
<b>Size (mm)</b>	Ø100 x 140 x 190	Ø120 x 220	220 x 147 x 166
	<p>Rotatable 90° Swivel Tripod Stand</p> <p><b>LED</b></p>	<p>Detachable Side Light-Flashing Amber   Retractable Tripod Stand</p> <p><b>LED</b></p>	<p>Swivel Stand Two Brightness Settings</p> <p><b>LED</b></p>
<b>Code</b>	<b>KB8933CP</b>	<b>KB2601A</b>	<b>KB2146-20W</b>
<b>Wattage</b>	10W	10W + 3W	20W
<b>Lumens</b>	650lm	850lm	1600lm
<b>Batteries</b>	Direct	7.4V 2400mAh	7.4V 2400mAh
<b>Rechargeable</b>	No 12VDC Car Plug	ACDC Adaptor / 12VDC Car Charger / USB	ACDC Adaptor / 12VDC Car Charger / USB
<b>Size (mm)</b>	280 x 290 x 320	208 x 122 x 240	226 x 165 x 179
	<p>6000K</p> <p><b>LED</b></p>	<p>6000K</p> <p><b>LED</b></p>	<p>6000K</p> <p><b>LED</b></p>
<b>Code</b>	<b>SP-016</b>	<b>SP-019</b>	<b>SP-010A</b>
<b>Wattage</b>	2 x 5W	2 x 10W	2 x 10W
<b>Lumens</b>	2 x 500lm	2 x 1000lm	2 x 1000lm
<b>Batteries</b>	4000mAh	3.7V 2 x 2000mAh	3.7V 2 x 2200mAh
<b>Rechargeable</b>	Yes (USB) Charge Time 4 hrs 3-6hours Run Time	Yes Charge Time: 5hrs Working Time: 2hrs 100%	Yes Charge Time: 4-5hrs Working Time: 2-4hrs
<b>Size (mm)</b>	252 x 207 x 50	Ø41 x 416	Ø65 x 650
<b>Features</b>	Magnetic Base   Battery Indicator Dimmable 100-50%	Back to Back Work Light   Can join two single sides Modes: 100% on / 50% on c/w Hook & Magnetic Vase	Double sided Work Light 360°   c/w Tripod   Hook Magnetic Bottom Modes: one side - two sides - off

2 Year warranty on all LED products, unless otherwise specified. Warranty void if adequate surge protection is not installed on LED products. See page 147

**TORCHES**

	HardCase Pivot	Impact Light	Basic Plastic Led	Water proof light	Tactical
					
<b>Code</b>	<b>EL-HC-PIVOT</b>	<b>EL-IMPACT-2AA</b>	<b>EL-PLASTIC-2D</b>	<b>EL-WPROOF-2AA</b>	<b>EL-TAC700-RC</b>
Lumens	300lm(high)/30lm Low	60lm	25lm	55lm	700lm
Batteries	2xAA included	2xAA included	2xD not included	2xAA included	Rechargeable
Working Time	5h(high)/30h(Low)	30h	120h	35h	Up to 2h
Effective distance	Up to 30M	65m	35m	50m	Up to 100m
IP rating	IPX4	-	-	IPX7	IPX4
Features	<ul style="list-style-type: none"> <li>• Pivoting Head</li> <li>• Magnetic foot</li> <li>• Drop tested: 7m</li> </ul>	<ul style="list-style-type: none"> <li>• Durable Rubber construction</li> <li>• Built in stand for hands free use</li> <li>• Non-slip grip</li> </ul>	<ul style="list-style-type: none"> <li>• Easy to operate</li> <li>• Long runtime</li> <li>• Lanyard included</li> </ul>	<ul style="list-style-type: none"> <li>• Floats</li> <li>• With reflective panels</li> <li>• Durable construction</li> </ul>	<ul style="list-style-type: none"> <li>• Durable aircraft grade aluminium</li> <li>• Strike bezel head</li> <li>• Multiple lighting modes</li> </ul>
					
<b>Code</b>	<b>SP-F08</b>	<b>SP-FL32</b>	<b>SP-FL3WC</b>	<b>SP-402-7C</b>	<b>SP-018</b>
Wattage	8W	1W	3W	0,5W	0.5W
Lumens	800lm	100lm	150lm	1200 - 1400 MCD	60lm
Batteries	3 x C (not incl)	3 x AAA (not Incl)	3 x AAA (Not Incl.)	3 x AAA (Not Incl)	-
Rechargeable	No	No	No	No	Yes (Shake to Recharge)
Size (mm)	Ø43 x 255	Ø25 x 91	Ø45 x 123	87 x 77 x 66	Ø27 x 170
	Comes in case with charger & car adaptor Spare Battery: <b>SP-T1000-BAT</b> 		Foldable Headlamp 90° Magnet Handle 	Signal lamp; Red, Green & White 	
<b>Code</b>	<b>SP-T1000</b>	<b>SP-BLH015</b>	<b>5JG-9915</b>	<b>5JG-A370</b>	
Wattage	1W	3W	3W (CREE)	3W (CREE)	
Lumens	100lm	120lm	330lm	330lm	
Batteries	3.7V Li-ion (Incl)	450mAh	3 x AAA (Incl)	2 x 18650 Lithium Battery (Incl)	
Rechargeable	Yes	USB	Yes	Yes	
Size (mm)	Ø32 x 155	Ø26 x 92	Ø55 x 195	Ø70 x 190	
	<b>5-in-1 Mini LED Pocket Lamp</b>  1 x USB 5VDC Charging Adaptor Colour Temp: 6000K c/w Magnet and Swivel Hook 	<b>Pen Light Magnetic Base &amp; Hook</b>  	<b>Aluminium Torch</b>  	<b>360° Rotatable Head Magnetic base Detachable head</b>  	<b>360° Rotatable Head Magnetic base Detachable head c/w Motion Sensor</b>  
<b>Code</b>	<b>SPWL-44AR</b>	<b>SP-WL32C</b>	<b>SP-SNL14D</b>	<b>HL-TC6145-1</b>	<b>HL-TC6145-2</b>
Wattage	20SMD + 3PCS	3W	3W	3W	5W
Lumens	400lm	200lm	120lm	100lm	300lm
Batteries	3.7V 1200mAh Lithium Battery	3 x AAA (Not Incl.)	4 x AAA (Not Incl.)	3 x AAA (Not Incl.)	3 x AAA (Not Incl.)
Rechargeable	Yes	No	No	No	No
Size (mm)	97 x 68 x 25	40 x 18 x 160	20 x 75 x 14	Ø76 x 75	Ø76 x 75

PORTABLE



LIGHTING



## HEADLAMPS

				
<b>Code</b>	<b>SJ-2469</b>	<b>SP22-B058B</b>	<b>SP-WL606</b>	<b>EL-V-HL-200lm</b>
Lumens	1300 MCD	12000-14000MCD	120lm	200lm(high)/45lm(low)
Batteries	3 x AAA (Not Incl)	3 x AAA (Not Incl)	3.7V 1200mAh	3 x AAA (Not Incl)
Work Time	-	-	-	7h(High)/20h(Low)
Effective Distance	-	-	-	Up to 50m
IP Rating	-	-	-	IPX4
Features	<ul style="list-style-type: none"> <li>• 2,4,8 LED On</li> <li>• LED flashing</li> <li>• OFF</li> </ul>	<ul style="list-style-type: none"> <li>• Mode 1: 1 LED ON</li> <li>• Mode 2: 7 LED ON</li> <li>• Mode 3: Flashing</li> </ul>	<ul style="list-style-type: none"> <li>• On/Off Wave Sensing</li> </ul>	<ul style="list-style-type: none"> <li>• Pivoting head</li> <li>• 2 modes</li> </ul>

## WATERPROOF BICYCLE HEAD LIGHTS

			
<b>Code</b>	<b>DY-H001</b>	<b>DY-H010</b>	<b>DY-H013</b>
Wattage	3W	6W	9W
Lumens	250lm	500lm	700lm
Light Modes	High / Low / Flash	Low / Medium / High / Flash	Low / Medium / High / Flash
Batteries	4.2V 2000mAh	8.4V 440mAh	8.4V 440mAh
Rechargeable	Yes	Yes	Yes

Kit Includes: Charger, Battery Pack, Battery Case, Headband, Mounting Ring

## BICYCLE LIGHTS

					
<b>Code</b>	<b>SJ-2657</b>	<b>JF404-1W</b>	<b>SJ-2750</b>	<b>SJ-2659</b>	<b>HL-BK4090</b>
Wattage	1.5W	1W	1.5W	0.3W	0.4W
Lumens	8400MCD	40000MCD	60000MCD	Head light: 2lm, Tail light: 3lm	4lm
Batteries	4xAA (not incl.)	3 x AA (36V 600mA) Incl	3 x AAA (not incl.)	Head 4 x AAA (not incl.) Rear 2 x AAA (not incl.)	3.7 280mAh Lithium Battery
Rechargeable	No	Yes	No	No	Yes
Size (mm)	52 x 80 x 112	85 x 72 x 100	32 x 54 x 80	95 x 30 x 50	43 x 27 x 40

2 Year warranty on all LED products, unless otherwise specified. Warranty void if adequate surge protection is not installed on LED products. See page 147

## CAMPING LIGHTS

<b>Code</b>	<b>YDC-5W-DL</b>	<b>CJ-2703</b>	<b>SJ-3040*</b>	<b>CS2008GN</b>	<b>EL-V-LANTERN-RC</b>
Wattage	5W	2W	1W	3W	-
Lumens	500lm	120lm	90lm	300lm	1000lm High
Batteries	3,7V 4400mAh Li-ion	2 x AA (Not Included)	3 x AAA (Not Included)	400mAh	-
Rechargeable	Yes   4-5hrs working time	No	No	Yes   Run time on full charge 8-10hr	Yes
Size (mm)	Ø80 x 117	Ø135	Ø135	Ø105 x 160	305 x 200 x 75

\*Add colour to code: ● **BK**(Black), ● **S**(Silver), ○ **WH** (White)

## DECORATIVE LED LAMPS

Shade Material:  
White glass  
Base Material:  
Painted  
Aluminium  
c/w Remote  
Control

<b>Code</b>	<b>TAM-RGB/WW</b>	<b>YAM-RGB/WW</b>	<b>GLAM-RGB/WW</b>	<b>LUCIA-RGB/WW</b>	<b>LUNA-RGB/WW</b>
Wattage	5.5W	5.5W	5.5W	6.5W	5.5W
Lamp Colour	RGB & Warm White	RGB & Warm White	RGB & Warm White	RGB & Warm White	RGB & Warm White
Size (mm)	Ø137 x 258	Ø137 x 258	Ø200 x 198	Ø200 x 200	Ø250 x 200
Spare Remote	<b>RGB/WW-REMOTE</b>	<b>RGB/WW-REMOTE</b>	<b>RGB/WW-REMOTE</b>	<b>RGB/WW-REMOTE</b>	<b>RGB/WW-REMOTE</b>
Material: Plastic		Various Colours Available 	Micro SD Card Slot 	Blow On & Off 	Hands Free, Wireless Music RF 10m Micro SD Touch Lamp 
<b>Code</b>	<b>OVORG-02</b>	<b>IM880-*</b>	<b>IM887</b>	<b>IM891</b>	<b>LV-2015</b>
Wattage	0.7W	0.55W	3W	0.5W	5W Speaker / 3.5W Light
Lamp Colour	RGB	White	RGB	Warm White	White
Feature	Colour Changing & Dimming	Glowing Mushroom Cap	Built in MP3 Player	Dimmable	Bluetooth
Size (mm)	Ø110 x 180	75 x 75 x 190	Ø109 x 241	80 x 80 x 120	Ø120 x 130

\* Add mushroom cap colour to code: ● **BL** (Blue), ● **GN** (Green), ● **O** (Orange), ● **Y** (Yellow), ● **P** (Purple)

## LED VENUE DECORATION LIGHTING

**Rechargeable Light Modules** - Working Time: 8 - 12 hrs. Charge Time: ±4hrs

<b>Code</b>	<b>SL-L117</b>	<b>SL-L117D</b>	<b>SL-L120DS</b>	<b>SL-L120D</b>
Power Output	2W	2W	1W	2W
Size (mm)	Ø117	Ø117	Ø120	Ø120
Charging Type	Induction Charging	Direct Charging	Induction Charging	Induction Charging
Kit Includes	LED light, remote control, battery, adaptor, waterproofing ring			

## LED DECORATIONS



Charger



Colour Changing

**LED Colour Changing Light Ball (Indoor)** - Rechargeable Batteries & 230VAC Battery Charger included | Colours include: Red, Green, Yellow, Blue, White, Cyan, Purple and Twinkle | Colour selectable or colour changeable by pressing switch | Batteries Included

Code	Volts	Core	Material	Size (mm)
LB-001	4.5V	Empty	Silica Gel	Ø81

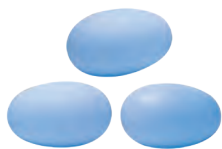

**Garden LED Egg Shaped Decorative Light Kit IP68** - 3 x Eggs with 1m cable from egg to egg | Colour: ● R, ● GN, ● BL | Single Colour or Colour Changing • Complete with Power Supply and 7m cable

SL333115	2.7W	Light 24VDC with controller 230VAC	Polyresin	165 x 95 x 85
----------	------	------------------------------------	-----------	---------------

## BELT LIGHTS



LED Filament Lamps Included!



Input Voltage: 240VAC | Illumination Cable c/w Lamp Holders at Set Spacing | Indoor & Outdoor Applications | c/w 2700K 2W LED filament lamps

Code E27	Length	Lamp Spacing	No of Lamps	Control Wires
DC-S14-10M-E27	10m	1m	10	2
DC-S14-15M-E27	15m	1m	15	2



B22



E27

Input Voltage: 100-240VAC | Illumination Cable c/w Lamp Holders at Set Spacing | Indoor & Outdoor Applications | 2 Wire for Static

IP65 Code B22	IP54 Code B22	Length	Lamp Spacing	No of Lamps	Control Wires
BL-10-B22	-	10m	450mm	20	2
BL-15-B22	BL-ACDC-15-B22	15m	375mm	40	2
-	BL-ACDC-50-B22	50m	700mm	70	2
BL-100-B22	BL-ACDC-100-B22	100m	700mm	143	2



Remote

Controller

Input Voltage: 230VAC | IP65 | Fixed RGBW Lamp | Lamp Type: G45 | c/w Controller | Ideal for Indoor and Outdoor Applications

Code E27	Length	Lamp Spacing	No of Lamps	Control Wires
BLS-10M-RGBW	10m	800mm	12	5



BL-LV-5M-M

Power Adaptor

**Coloured LED Belt Light - IP44** - Input Voltage: 230VAC | Low Voltage Outdoor Party & Festive Lights | c/w Transformer | Power Cable Length: 5m | Connectable | Filament LED | Plastic Bulb with Mounting Hooks

Code	Length	Lamp Spacing	No. of Lamps
<b>LED Golf Ball Multi-Colour</b>			
BL-LV-5M-M	5m	500mm	10
<b>LED A60 Multi-Colour</b>			
BL-LV-A60-5M-M	5m	500mm	10
<b>LED G45 RGB (Auto Colour Changing)</b>			
BL-LV-G45-5M-RGB	5m	500mm	10

BL-LV-A60-5M-M



**Solar Powered LED Belt Light - IP65** - c/w 6W, 6V Panel | 240 x 150mm | 1W LED Lamps | Charge Time: 8-10Hrs | Working Time: 13-15Hrs | LiPo 5200mAh Battery | Ideal for Indoor and Outdoor Applications | Colour Temp: 3000K

Code E27	Length	Lamp Spacing	No of Lamps	Control Wires
SOL-BL-7.3M-WW	7,3m	730mm	10	2
SOL-BL10.4M-WW	10,4m	800mm	10	2

SOL

**LED ROPE LIGHTS IP44**

10 000 Hours life	<b>2-Wire Round</b>	<b>3-Wire Round</b>	<b>2-Wire Rectangular</b>		<b>3-Wire Rectangular</b>	
	<b>13mm</b>	<b>13mm</b>	<b>5 x 8</b>	<b>11 x 18</b>	<b>11 x 18</b>	
● Red	RL-LED2-*R	RL-LED3-*R	MLF-*R	RE-L2-*R	RE-L3-*R	
● Green	RL-LED2-*G	RL-LED3-*G	MLF-*G	RE-L2-*G	RE-L3-*G	
● Blue	RL-LED2-*B	RL-LED3-*B	MLF-*B	RE-L2-*B	RE-L3-*B	
● Yellow	RL-LED2-*Y	RL-LED3-*Y	MLF-*Y	RE-L2-*Y	RE-L3-*Y	
● Orange	-	-	MLF-*O	-	-	
● White	-	-	MLF-*W	RE-L2-*W	RE-L3-*W	
○ Warm White 2700K	RL-LED2-*WW	RL-LED3-*WW	-	-	-	
○ Day Light 6000K	RL-LED2-*DL	RL-LED3-*DL	-	-	-	
Mixed (R, G, Y, B)	RL-LED2-*M	RL-LED3-*M	-	RE-L2-*M	RE-L3-*M	
*Add Length to code: <b>10m</b> or <b>50m</b>						
Controller	To be ordered separately		To be ordered separately		To be ordered separately	
Accessories supplied	All 10 meter Flexi Lights are supplied with: Power Cord, End Cap and 6 piece Mounting Clips All 50 meter Flexi Lights are supplied with: Power Cord, 3 Middle Joint Connectors, 3 End Caps and 30 piece Mounting Clips					
Watts/M	R, Y, M: 1.56W/m B, G, W: 2.6W/m					

Accessories for:	2-Wire Round	3-Wire Round	5 x 8 2-Wire	11 x 18 2-Wire	11 x 18 3-Wire	Mounting rails for 5 x 8 LED rope light								
Power Cord 1.6A	-	-	ML-1.6A	-	-	<table border="1"> <thead> <tr> <th>Code</th> <th>Description</th> </tr> </thead> <tbody> <tr> <td>CH-1PVC</td> <td>PVC mounting rail</td> </tr> <tr> <td>CH-2PVC</td> <td>Step edge to carpet mounting rail</td> </tr> <tr> <td>CH-3PVC</td> <td>Mounting rail for carpet both sides</td> </tr> </tbody> </table>	Code	Description	CH-1PVC	PVC mounting rail	CH-2PVC	Step edge to carpet mounting rail	CH-3PVC	Mounting rail for carpet both sides
Code	Description													
CH-1PVC	PVC mounting rail													
CH-2PVC	Step edge to carpet mounting rail													
CH-3PVC	Mounting rail for carpet both sides													
Converter 4A	-	-	ML-4A	-	-									
Controller for 10m	WK-220	WI-310B	-	-	-									
8 Function Controller 50m	DK-05-2	DK-06-4	SL-210-10A SL-410-2A	DK-05-2-RE	DK-06-4-RE									
Power Cord c/w Connector	F-1-LED	RL-1-LED	-	SF2-1	SF3-1									
End Caps	F-4	F-4	ML-3	SF2-3	SF2-3									
Coupling (Splice Conector)	F-5	RL-5	ML-4	SF2-4	SF3-4									
Mounting Clip, Plastic	F6	F6	ML-5	SF2-5	SF2-5									

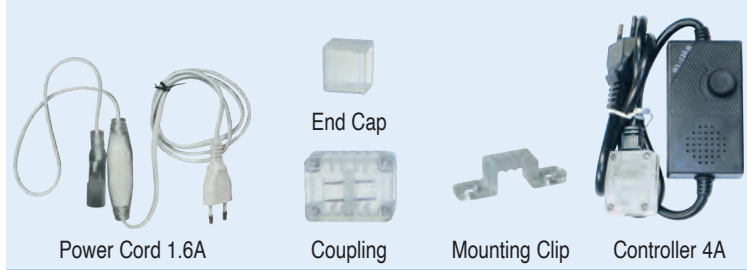

**Rope Length for MLF Series only**

Colour	Watts	Max. length with the following converters	
		1.6A	4A
● White	2.6W	160m	400m
● Red	1.56W	264m	660m
● Blue	2.6W	160m	400m
● Green	2.6W	160m	400m
● Yellow	1.5W	264m	660m

FESTIVE

**NEW LED ROPE LIGHT WITH CONTROLLER**



**LED 13mm Ø Special Flexilight IP65 - 230V. (Controller (IP44) to be mounted in weatherproof box)**

<b>Colour</b>	<b>3 Wire (3 Colour Chasing) 10m c/w controller</b>
Red, White, Yellow & Blue	<b>LED-RL-3W-10M</b>
Clear / LED DL	<b>LED-RL-3W-10C-DL (6000K) Daylight</b>
Clear / LED WW	<b>LED-RL-3W-10C-WW (3200K) Warm White</b>
Above Flexilights are supplied complete with mains cords, end cap, connector and 8 function controller.	
<b>Colour</b>	<b>2 Wire 3-Colour 10m c/w multi-function controller</b>
Red, Green, & Blue	<b>LED-RL-2W-10M</b>
Above Flexilights are supplied complete with mains cords, end cap, connector and 8 function controller.	

LIGHTING

## ROPE LIGHTS & CONTROLLERS

**13mm Ø Flexilights with Non Fuse Lamps** (when one lamp is defective a section of lamps will go off)

**13mm Ø Flexilights with Fuse Lamps** (when one lamp is defective, only that lamp will go off without affecting a section of lamps)

• 30 000Hrs • 16,5W/M • UV resistant • 240VAC • **IP44**



Colour	●● 2 Wire Steady/Flashing	●●● 3 Wire Chasing
<b>Type of Lamps</b>	<b>With Fuse Lamps</b>	<b>With Fuse Lamps</b>
Red ●	IF-2*-R	IF-3*-R
Green ●	IF-2-50-G	IF-3-10-G
Blue ●	IF-2-10-B	IF-3*-B
Yellow ●	IF-2-10-Y	IF-3-10-Y
Orange ●	IF-2-10-OR	IF-3-10-OR
Neon Green ●	IF-2*-NG	IF-3-10-NG
Neon Orange ●	IF-2-10-NO	IF-3*-NO
Pink ●	IF-2*-PK	IF-3*-PK
Purple ●	IF-2*-P	IF-3*-P
Mixed (R, G, Y, B)	IF-2*-M	IF-3-10-M
Aqua Blue ●	IF-2*-AB	IF-3*-AB
Sakura Pink ●	IF-2*-SP	IF-3*-SP

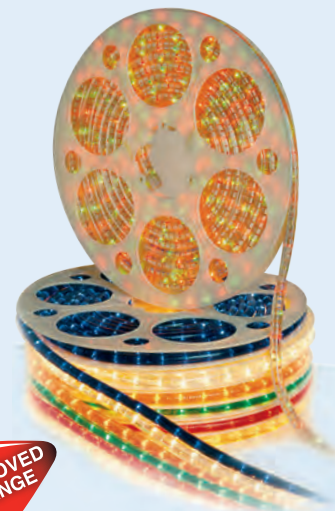

\*Add Length: 10m or 50m.

Bulb Specification: 36 bulbs/meter 6.5V 0.07A, 0.46W

All 10m Flexilights are supplied complete with mains cords, end cap and connector.

All 50m Flexilights are supplied with 3 x mains cords, 3 x end caps & 3 x connectors.

Controllers to be ordered separately (see below).



Yellow

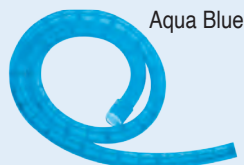

Aqua Blue



Sakura Pink

### Accessories 13mmØ

Description	●● Code 2 Wire	●●● Code 3 Wire
Mains cord c/w connector	F-1	RL-1
Powercord connector	F-3	RL-3
End cap	F-4	F-4
Flexilight Coupling (splice connector)	F-5	RL-5
Mounting clip	F-6	F-6
Easy Splice connector with shrink tube	F-7	RL-7
Y Cord to join 3 lengths	F-9	RL-9
Suction Cups	F-10	F-10
T Connector	F-11	RL-11
PVC Channel – clear, 1 meter length	F-12	F-12
Waterproof Coupling (splicing kit) to be filled with Silicon Glue	F-14	RL-14
	F-28	F-28



### Controllers 240VAC

Description	Speed Adj.	Function	Max Loading	Max Amps	Code 2 Wire	Code 3 Wire
Indoor <b>IP44</b>	Yes	Flashing	17m	1.2A	WL-220	–
Indoor <b>IP44</b>	Yes	Chasing	17m	1.2A	–	WL-310
Indoor <b>IP44</b>	Yes	Flashing	30m	2.2A	WL-210C	–
Indoor <b>IP44</b>	Yes	Chasing	30m	2.2A	–	WL-310C
Indoor <b>IP44</b>	No	8 Function w/mem	12m	1.2A	WL-310B-DI2C	WL-310B
Indoor <b>IP44</b>	Yes	Static, Flashing	100m	8A	WL-2C	–
Indoor <b>IP44</b>	Yes	Static, Flashing	100m	8A	WL-2C-2P*	–
Indoor <b>IP44</b>	Yes	6 Function chasing	100m	8A	WL-3C-DI2C	WL-3C
Indoor <b>IP44</b>	Yes	6 Function chasing	100m	8A	–	WL-3C-2P*
Outdoor <b>IP55</b>	Yes	8 Function	17m	1.2A	–	WL-310K
Outdoor <b>IP55</b>	No	8 Function	30m	2.2A	–	–
Outdoor <b>IP55</b>	No	16 Function	25m	1.8A	–	WL-318



\* With 2 Output Connectors for controlling 2 Flexilights, max 100m total length.

**ROPE & FIREWORK FLEXILIGHTS**



**10mm Ø Flexilight (with fuse lamps) IP65**

Colour	Symbol	2 Wire (Steady/Flashing) 10m
Red	●	RL2-10-10R
Yellow	●	RL2-10-10Y
Mini controller for 10m IP44		DN-2W-2C

**Accessories**

Code	Description
F10-4	Spare End Cap for 2-wire 10mm diameter Flexilight
F1-4	Mains Cable c/w Connector

Flexilights are supplied complete with mains cords, end cap and connector.  
Controller to be ordered separately see page 177.



**Rectangular Flexilight 11mm(H) x 18mm(W) with fuse lamps IP65**

Colour	11mm 18mm Symbol	2 Wire Steady/Flashing	11mm 18mm Symbol	3 Wire Chasing
Clear	○	SF2M-*C	○	SF3M-*C
Red	●	SF2M-*R	●	SF3M-*R
Green	●	SF2M-*G	●	SF3M-*G
Aqua Blue	●	SF2M-*AB	●	SF3M-*AB
Yellow	●	SF2M-*Y	●	SF3M-*Y
Neon Green	●	SF2M-*NG	●	SF3M-*NG
Neon Orange	●	SF2M-*NO	●	SF3M-*NO
Mixed (R, G, B, Y)		SF2M-10M		SF3M-*M

**Accessories**

Description	Code 2 Wire	Code 3 Wire
Mains Cord and Connector	SF2-1	SF3-1
End Cap	SF2-3	SF3-3
Coupling (splice connector)	SF2-4	SF3-4
Mounting Clips (plastic)	SF2-5	SF2-5
*Controller for 10m Indoor	WL-220-R	WL-310-R
*Controller for 100m Indoor	WL-2C-R	WL-3C-R

\*Add length to code: 10m or 50m Flexilights are supplied complete with mains cords, end cap and connector.

Flexi-Firework is composed of segments of Hollow Flexilight and Flexi-Star fixed on a metal frame. It spreads out at the top of the pillar to create fantastic firework effects. In recent years, Flexi-Firework has become popular all over the world for celebrations, and festive purposes in both small and large scale applications.

Description	Max. Height of Luminary	Max. Ø of Luminary	Power Consumption 220V-240V	Code
Fountain	2.4m	4.5m	3550W	FA-FW-003-M
Tempting Goddess	3.25m	3m	2450W	FA-FW-004-M
Jellyfish Star	2.1m	3.8m	2930W	FA-FW-005-M
Star War	2.5m	3m	3550W	FA-FW-006-M
Forest	2m	4.5m	3550W	FA-FW-008-M
Star Fountain	2m	3m	900W	YF-B6014
Festival	2m	3m	900W	YF-B6016



FA-FW-004M

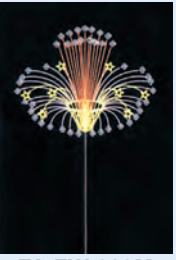

FA-FW-003M

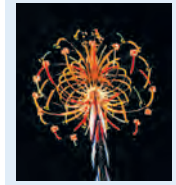

FA-FW-006M



YF-B6016

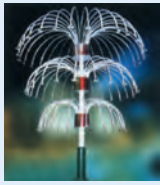

YF-B6014



FA-FW-008M



FA-FW-005M

*Pole sold separately*  
Code FA-POLE  
3m x 75mm ø

**LASER PROJECTORS IP44**



TOP-A1

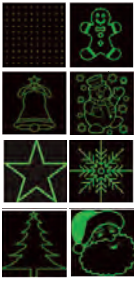

Projected Images

**Laser Shower** - Input Voltage: 230VAC | c/w Remote, Ground Spike & Tri-Pod | Fairy Light Projection and various images

Code	Projection	Beam Distance	Coverage	Size
TOP-A1	Red/Green Laser	30m	3000ft <sup>2</sup>	240 x 183 x 127

**Landscape Projector** - Input Voltage: 230VAC | c/w Remote, Ground Spike & Tri-Pod | Project Images using slides (Additional Slides to be ordered separately) | Supplied with Slides 3 & 4

Code	LED	Beam Distance	Coverage	Size
TOP-B1	4 x 3W LED	10m	600ft <sup>2</sup>	Ø95 x 135 x 140

**TOP-B1 Accessories**

Code	Description	Code	Description
TOP-B1-SLIDE1	C3 & C4 Slide for TOP-B1	TOP-B1-SLIDE3	C1 & C2 Slide for TOP-B1
TOP-B1-SLIDE2	C5 & C6 Slide for TOP-B1	TOP-B1-SLIDE4	C7 & C8 Slide for TOP-B1

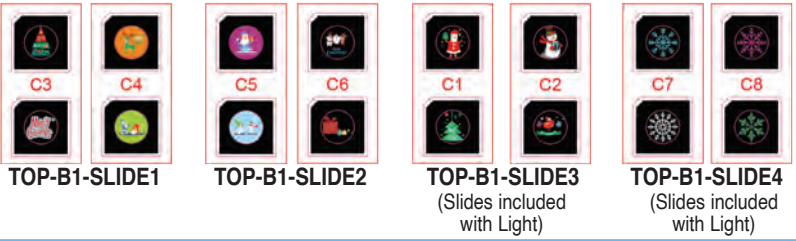

TOP-B1-SLIDE1 TOP-B1-SLIDE2 TOP-B1-SLIDE3 (Slides included with Light) TOP-B1-SLIDE4 (Slides included with Light)



TOP-B1



FESTIVE LIGHTING

## LED FESTIVE LIGHTS IP44

**LED Flexi-Star - Indoor/Outdoor Tree Lights (100 000 hours) 240V**

Code	Colour of Bulb	No. of Channel	Length	No. of Bulbs	Controller Included IP44	Watts Total
LS2-80WW-8-W	WW (2700K)	2	8m	80	8 Function	3.2W
LS2-100C-12-G	White (5500K)	1	12m	100	8 Function	9.6W
LS2-160C-5-*	White (5500K)	2	5m	160	8 Function	6.4W
LS4-160C-5-*	White (5500K)	4	5m	160	8 Function	6.4W
LS2-160R-5-*	Red	2	5m	160	8 Function	6.4W
LS2-160B-5-*	Blue	2	5m	160	8 Function	6.4W
LS2-160M-5-*	Multi	2	5m	160	8 Function	6.4W
LS2-320C-10-*	White (5500K)	2	10m	320	8 Function	12.8W
LS4-320C-10-*	White (5500K)	4	10m	320	8 Function	12.8W
LS2-320M-10-*	Multi	2	10m	320	8 Function	12.8W

\*Add colour of wire to code: ● G (Green), ○ W (White), ○ T (Transparent)



**LED Net Lights - (100 000 hours) 240V Indoor use only IP44 (extendable)**

Code Black Wire	Code Clear Wire	Code White Wire	Colour of Bulbs	Size	Lamp		8 Function Controller
					No.	W (total)	
LFN-252-C-G	LFN-252-C-C	LFN-252-C-W	White (5500K)	1.5 x 2m	252	16,8W	Included
LFN-324-C-G	LFN-324-C-C	LFN-324-C-W	White (5500K)	1.5 x 3m	324	16,8W	Included
LFN-252-M-G	LFN-252-M-C	LFN-252-M-W	Multi	1.5 x 2m	252	19W	Included
LFN-324-M-G	LFN-324-M-C	LFN-324-M-W	Multi	1.5 x 3m	324	28W	Included
LFN-252-WW-G	LFN-252-WW-C	LFN-252-WW-W	Warm White	1.5 x 2m	252	19W	Included
LFN-324-WW-G	LFN-324-WW-C	LFN-324-WW-W	Warm White	1.5 x 3m	324	28W	Included

**Curtain Light - (100 000 Hours) Indoor use only. IP44 (extendable)**

Code White Bulb (5500K)	Code Warm White Bulb	Curtain Width x Drop	No of Strings	Lamps per String	Watts
LFC3C-20-2/1*	LFC3WW-20-2/1*	2 x 1.0m	20	36	16.8W
LFC3C-20-2/1.5*	LFC3WW-20-2/1.5*	2 x 1.5m	20	36	16.8W
LFC3C-20-2/3*	LFC3WW-20-2/3*	2 x 3m	20	36	33.6W
LFC3C-20-2/5*	LFC3WW-20-2/5*	2 x 5m	20	72	67.2W
LFC3C-20-2/10*	LFC3WW-20-2/10*	2 x 10m	20	108	100.8W

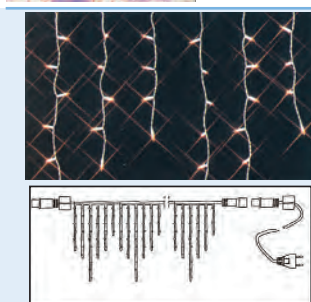
\* Add -W to code for White Wire. Standard items supplied with Black Wire. Controller to be ordered separately. Note IP rating of controller. WL-310B-LFC3C (1.2A) 288W IP44. WL-310K-LFC3C (1.2A) 288W IP55

**Icicle Light - (100 000 Hours) 240V Indoor use only. IP44 extendable**

Code	No. of Channel	Length		No. of Bulbs	Power Watts	Controller Included
		W	H			
LF11-60*-1.7*	1	1.7m	0.5m	60	4.8W	Excluded
LF11-90*-2.5*	1	2.5m	0.5m	90	4.8W	Excluded
LF11-240*-5*	1	5m	1m	240	9.6W	Excluded
LF11-250-WW-W	1	3.5m	1m	250	9.6W	Excluded
LF14-240*-5*	4	5m	1m	240	9.6W	8 Function

\*Add colour to code: ○ CW (Cool White 5500K), ○ WW (Warm White)

\*Add colour of wire to code: ● GN (Green), ○ W (White), ○ T (Transparent)

**LED Round Sparkle Net Lights - (100 000 hours) 240V Indoor use only**

Code Green Wire	Colour of Bulbs	Type	Size	LED Quantity	Controller Included
CM-RNL-C	White	Chasing	1m Ø	80	2 Function
CM-RNL-M	Multi	Chasing	1m Ø	80	8 Function

**LED Extendable Flexi-Star - (100 000 hours) Indoor/Outdoor use. PVC wire. IP44**

Code Green Wire	Colour of Bulb	No. of Bulb				Power Consumption				Max. Extendable Set			
		5m	10m	12m	50m	5m	10m	12m	50m	5m	10m	12m	50m
LRS2-100C-*-*	White (5500K)	-	-	100	500	-	-	7.6W	38.14W	-	-	20	4(sets)
LRS2-100M-*-*	Multi	-	-	100	500	-	-	7.6W	38.14W	-	-	20	4(sets)
LRS2-160C-12-*	White (5500K)	160	-	160	800	9.6W	-	9.6W	48W	20	-	20	4(sets)
LRS2-160C-50-*	White (5500K)	160	-	160	800	9.6W	-	9.6W	48W	20	-	20	4(sets)
LRS2-160M-*-*	Multi	-	-	160	800	-	-	9.6W	48W	-	-	20	4(sets)

**LED Flexi-Star - (100 000 hours) Indoor/Outdoor use. PVC wire. IP44**

Code	Colour of Bulb	No. of Bulb	Power Consumption	Max. Extendable Set
LRS2-160C-5-*	White (5500K)	160	9.6W	Not Extendable
LRS2-320C-10-*	White (5500K)	320	19.2W	Not Extendable
LRS2-320M-10-10-G	Multi	320	19.2W	Not Extendable

\*Add length to code: 5 (5m), 12 (12m) or 50 (50m)

\*Add colour of wire to code: ● G (Green), ○ W (White)

NEW

## LED STRING LIGHT IP44

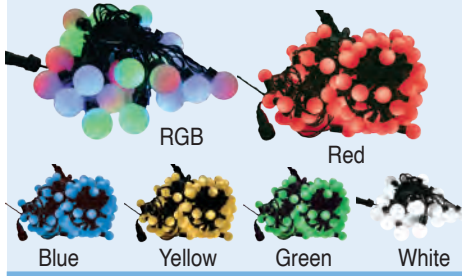

Voltage: 230VAC | Supplied with 1.5m Power Cord | Linkable | Moulded LED Lamps | No Controller required for multi-colour | Suitable for outdoor use

Code	Wattage	LED Bulbs	Length	Colour
ST-102T-5M-50-M	4.4W	50	5m	RGB (● ● ●)
ST-102T-10M-100-M	8.8W	100	10m	RGB (● ● ●)
ST-102T-5M-50-*	4.4W	50	5m	● ● ● ● ●

\*Add colour to code: ● R (Red), ● Y (Yellow), ● BL (Blue), ● GN (Green), ○ W (White) 6000K

## FESTIVE LIGHTS



Flexi-Star Indoor/Outdoor TREE LIGHTS (28 000 hours) 240V

Code	Colour of Bulb	No. of Channel	Length	No. of Bulbs	Controller Included IP44	Watts
FS2-160C-5-*	Clear	2	5m	160	8 Function	96W
FS4-160C-5-*	Clear	4	5m	160	16 Function	96W
FS2-160R-5-*	Red	2	5m	160	8 Function	96W
FS2-160B-5-*	Blue	2	5m	160	8 Function	96W
FS2-160M-5-*	Multi	2	5m	160	8 Function	96W
FS2-320C-10-*	Clear	2	10m	320	8 Function	68W
FS4-320C-10-*	Clear	4	10m	320	16 Function	68W
FS2-320M-10-*	Multi	2	10m	320	8 Function	68W

\*Add colour of wire to code: ● GN (Green), ○ W (White), ○ T (Transparent)

Controller WL-310B with memory. For outdoor use, controller to be mounted in weatherproof box



(25 000 Hours) 240V Indoor use only. Green Wire

Code Clear Bulbs	Length	No	W (total)	Controller Included IP44	Code Multicolour Bulbs
MTL-96B-6M-C	6m	96	37W	8 Function	MTL-96B-6M-M
MTL-144B-9M-C	9m	144	66W	8 Function	MTL-144B-9M-M
MTL-180B-10M-C	10m	180	104W	8 Function	MTL-180B-10M-M

Net Light IP44

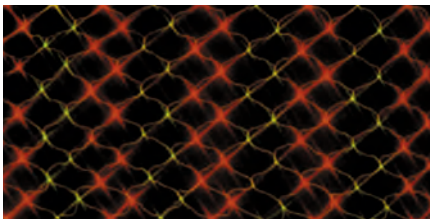

Code Green Wire	Colour of Bulbs	Size	No of Bulbs	Watts	Controller Included IP44	Code Clear Wire
NL-288-C-G	Clear	1.5 x 2m	288	96W	8 Function	NL-288-C-T
†NL-432-C-G	Clear	1.5 x 3m	432	115W	8 Function	NL-432-C-T
NL-288-M-G	Multi	1.5 x 2m	288	96W	8 Function	NL-288-M-T
NL-432-M-G	Multi	1.5 x 3m	432	115W	8 Function	NL-432-M-T

†For outdoor add 'OD' to code. eg ODNL-432-C-G



Icicle Light (30 000 Hours) 240V Indoor use only. IP44 extendable

Code Green Wire	No. of Channel	Length W H	No. of Bulbs	Power Watts	Controller
FI1-60C-1.7*	1	1.7m 0.5m	60	24	Excluded
FI1-90C-2.5*	1	2.5m 0.5m	90	45	Excluded
FI1-240C-5*	1	5m 1m	240	62	Excluded
FI4-240C-5*	4	5m 1m	240	120	8 Function (IP44)

\*Add colour of wire to code: ● GN (Green), ○ W (White), ○ T (Transparent)

Curtain Light (30 000 Hours) Indoor use only. IP44 black wire



Code Clear Bulbs	Curtain Width x Drop	No of Strings	Lamps per String	W (total)	Extendable Sets Max	Controller Excluded
FC3C-20-2/1	2 x 1.0m	20	36	332W	10	WL-310C-FC3C
FC3C-20-2/1.5	2 x 1.5m	20	36	332W	10	(2.2A) 506W IP44
FC3C-20-2/3	2 x 3m	20	36	332W	10	WL-310G-FC3C
FC3C-20-2/5	2 x 5m	20	36	332W	10	(2.2A) 506W IP55
FC3C-20-2/10	2 x 10m	20	36	332W	10	WL-3C-FC3C
CLS-2X6M	2 x 6m	24	74B	570W	-	(8A) 1840W IP44
CLS-2X9M	2 x 9m	24	111B	691W	-	

FESTIVE

LIGHTING



## LED FESTIVE LIGHTS

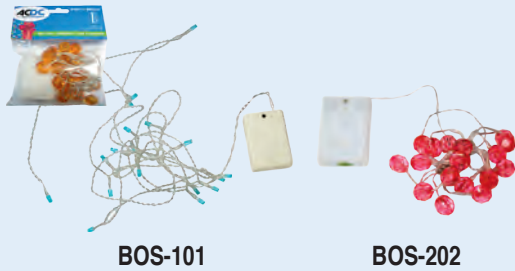

**Battery Operated Starlight** - Indoor use only | 2 Wire LED light string with white battery box | Wire colour: Silver | Voltage 4,5V (3 x AA) Excluded | Length: 2 meter | 20 LEDs in a 2 meter Length | Approximate battery life: 72 HRS (Dependant on type of battery)

Code	Description	*Add Colour to Code
<b>BOS-101*</b>	Battery operated LED flexistar	○ WW (Warm White), ○ CW (Cool White), ● R (Red), ● BL (Blue), ● GN (Green), ● Y (Yellow), ● G (Gold)
<b>BOS-202*</b>	Battery operated LED flexistar with clear crystal balls	○ WW (Warm White), ○ CW (Cool White), ● R (Red), ● BL (Blue), ● GN (Green), ● Y (Yellow), ● OR (Orange)

## SOLAR FESTIVE LIGHTS IP44

3 Levels on timer: 6h, 8h and 10h adjustable | Working time after full charge: 20-40hrs (time for full charge: 8hrs in direct sunlight) | Charging period for one night (±8-16hrs): 4hrs in direct sunlight | On/Off: automatically turn on at 75±25lx, turn off at 350±50lx in one minute by photo sensor



Code	TEA-7D02-B05*	TEA-7D02-B10*	TEA-7D06-B10*	TEA-7D06-B20*	TEA-7D08-B10*	TEA-7D08-B20*	TEA-7D10-B20*
Length (m)	5	10	1.6 x 0.6	2.0 x 1.0	1.6 x 0.6	2.0 x 1.4	1.6 x 0.6
No of LEDs	50Pcs	100Pcs	96Pcs	200Pcs	96Pcs	200Pcs	96Pcs

\*Add colour to code: ○ CW (Cool White), ●●●M (RGB)

## LED FESTIVE LIGHTS IP44



Code	LEDs	Watt	Colour	Description
<b>LCLT-*G-RGB</b>	160/10m	7W/10m	RGB	LED RGB Clip light colour changing; c/w 8 function controller; 4 wire
<b>LCLT-*G-RGB-AUTO</b>	160/10m	7W/10m	RGB	LED RGB clip light auto colour changing; with controller to control fading; 2 wire
<b>LCLT-*G-WW</b>	160/10m	7W/10m	White	LED warm white clip light c/w transformer; no controller; 2 wire
<b>LCLT-*G-PW</b>	100/10m	7W/10m	White	LED pure white clip light c/w transformer; no controller; 2 wire

\*Add length to code: **10** (10m), **50** (50m), **100** (100m)

### LED Knitting Lights

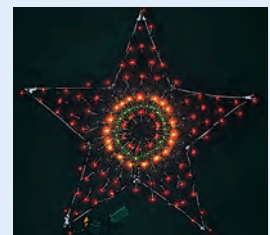

Code	CM-STR-M
80 Red, 20 Green, 20 Yellow & 20 Blue LED's. Complete with 8 function Controller. Voltage: 240V. Size: 910 x 910mm.	

## LED TUBE EFFECT LIGHTING



**LED Falling Star Effect Tubes** - Input Voltage: 220VAC

Code	Effect	1 Kit	Size (mm)	LED's/Tube
<b>RW-LK60-33*</b>	Chasing	5Pcs	Ø12 x 600(L)	33 LED's

\*Add colour to code: ● R (Red), ● GN (Green), ● Y (Yellow), ● BL (Blue), ○ WH (White), ●●● RGB  
Kit includes connecting cables and mains adaptor

## LED BALL MOTIF



### Smart LED Christmas Tree

Code	Description
<b>LED-LBL-220L-*</b>	Ø600mm Ball motif with 150 LEDs, black wire, Indoor
<b>LED-LBL-80L-*</b>	Ø300mm Ball with 55 LEDs, black wire, Indoor

\*Add LED colour to code: ○ W (White), ● R (Red), ● GN (Green), ● Y (Yellow), ● BL (Blue)

## SMART XMAS TREE



Input Voltage: 100-240VAC  
100+ Light Shows App Controlled | RGB, 16 million colours | 2.4G Wifi | c/w Controller

Code	FI-710
No. of Strings	7
No. of LEDs / String	10
String Length	140cm
Max Wattage	15W

NEW

3D LED MOTIFS



Code	SM-I-001-220V	SM-I-002-220V	SM-I-003-220V	SM-I-065-220V	SM-I-066-220V
Size	1200 x 1000mm	2100 x 1300mm	1200 x 800mm	Ø300mm	Ø600mm
Wattage	77W	115W	77W	4W	8W



Code	SM-I-007-220V	SM-I-008-220V	SM-I-009-220V	SM-I-077A-220V
Size	1000 x 650mm	600 x 830mm	400 x 360mm	3500 x 1100mm
Wattage	35W	35W	8W	115W

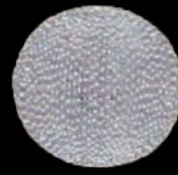

Code	SM-I-072A-220V	SM-I-072B-220V	SM-I-072C-220V	SM-I-057-220V
Size	Ø400mm	Ø600mm	Ø800mm	Ø400mm
Wattage	16W	23W	27W	8W



Code	SM-I-045A-220V	SM-I-045B-220V	SM-I-045C-220V	PHS-084-220V
Size	420 x 400 x 260mm	320 x 400 x 260mm	200 x 200 x 160mm	600 x 550 mm
Wattage	6W	3W	2.5W	60W

FESTIVE

NEW

LASER ETCHED ACRYLIC MOTIF



Code	SM-C-002-220V-*	SM-C-001-220V-*	SM-C-003-220V-*
Size	330 x 310mm	330 x 310mm	450 x 430mm
Wattage	5W	5W	5W

LIGHTING

\*Add colour to code: ○ CW (Cool White), ● R (Red), ● BL (Blue), ● GN (Green)

### 3D LIGHT MOTIF WITH STANDARD (28 000hr) LAMPS



Code	BLM-1103	BLM-1105	BLM-1106	BLM-1107	BLM-1111
Size	640 x 450mm	440 x 720mm	920 x 870mm	1120 x 690mm	400 x 1300mm
Wattage	98.28	10.2	212.94	180.18	37.4

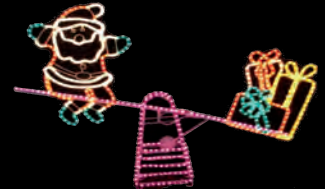

Code	BLM-1113	BLM-1114	BLM-1115	BLM-1118
Size	780 x 2400mm	530 x 1300mm	530 x 1100mm	650 x 1400mm
Wattage	54.4W	196.8W	23.8W	213.2W

### MINI ROPE LIGHT MOTIF WITH STANDARD (28 000hr) LAMPS

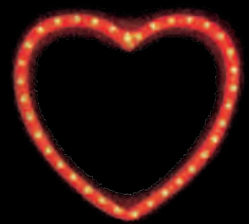
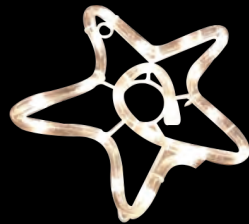

Code	DNM-003	DNM-007	DNM-009	DNM-012	DNM-013
Size	250 x 330mm	230 x 290mm	260 x 340mm	170 x 410mm	350 x 340mm
Wattage	1.7W	1.7W	1.7W	1.7W	1.7W

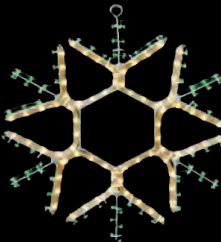
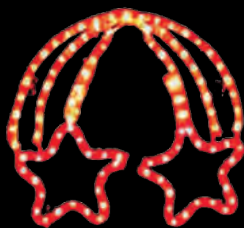

Code	NL-202	NL-105	NL-301	NL-201	NL-104
Size	360 x 420mm	400 x 500mm	Ø410mm	500 x 380mm	560 x 440mm
Wattage	8.5W	6.8W	6.8W	5.1W	6.8W



3000K

Code	BLM-1200*	BLM-1205	BLM-1206	LTL-CHERRY-1.8M-WW
Size	1200mm	800mm	1200mm	1800mm
Wattage	58W	8W	8W	6W
Colour	White/Black	White	White	Cherry

\*add -BK to code for Black

**MINI ROPE LIGHT MOTIF WITH STANDARD (28 000hr) LAMPS**



Code	NL-205	NL-303	NL-204	NL-113	NL-112
Size	570 x 380mm	600 x 340mm	640 x 480mm	640 x 480mm	640 x 550mm
Wattage	5.1W	6.8W	8.5W	6.8W	8.5W

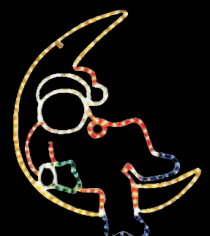

Code	NL-527	NL-116	NL-535	NL-504	NL-525
Size	650 x 850mm	680 x 480mm	750 x 580mm	750 x 750mm	730 x 930mm
Wattage	147.6W	8.5W	11.9W	15.3W	13.6W



Code	NL-503	NL-524	NL-306	NL-305	NL-307
Size	800 x 800mm	800 x 800mm	810 x 810mm	930 x 780mm	930 x 730mm
Wattage	11.9W	13.6W	10.2W	10.2W	212.94W



Code	NL-519	NL-312	NL-542	NL-543	NL-514
Size	1080 x 820mm	1100 x 750mm	1200 x 783mm	1200 x 870mm	1200 x 1200mm
Wattage	6.2W	327.6W	13.6W	18.7W	377.2W

• Indoor/Outdoor use • 2 Wire Connection • Supplied without controller, for controllers see page 177.

FESTIVE

LIGHTING

## MINI ROPE LIGHT MOTIF WITH STANDARD (28 000hr) LAMPS



Code	NL-528	NL-401	NL-604	NL-626	NL-630
Size	1230 x 1110mm	1330 x 1110mm	1500 x 700mm	1530 x 1000mm	1900 x 1300mm
Wattage	278.46W	393.6W	147.42W	18.7W	458.64W



Code	NL-605	NL-606	NL-614	NL-624
Size	2000 x 1000mm	2000 x 1100mm	2000 x 1100mm	2500 x 900mm
Wattage	13.6W	15.3W	15.3W	295.2W



Code	NL-622	NL-609	NL-545	NL-314	NL-636
Size	2500 x 1100mm	3400 x 1200mm	600 x 1400mm	730 x 1850mm	2000 x 1500mm
Wattage	278.8W	687.96W	164W	229.32W	606.8W



Code	NL-417	NL-638	NL-639	NL-660	NL-643
Size	1000 x 2000mm	1100 x 1500mm	1200 x 1500mm	1000 x 3500mm	1300 x 3500mm
Wattage	311.6W	30.6W	344.4W	492W	752W



Code	NL-648	NL-654	NL-655	NL-661
Size	1500 x 3320mm	1000 x 4000mm	1200 x 6200mm	1000 x 4000mm
Wattage	606.80W	557.6W	967.60W	820W

• Indoor/Outdoor use • 2 Wire Connection • Supplied without controller, for controllers see page 177.

2 Year warranty on all LED products, unless otherwise specified. Warranty void if adequate surge protection is not installed on LED products. See page 147

LIT

© ACDC Dynamics

## POWER TEST CASE



### Lamp Power Test Case

Code	Description
LT-SM966	100/250VAC Digital On/Off Power Tester

#### Displays the following:

Supply Voltage | Current Consumed | Lamp Power | Lamp Power Factor  
Annual Power Consumption Calculation

#### Comes with:

Lamp holder adaptors for most lamps and socket outlet for testing fittings

For more AC/DC In-Store Promotional Displays please contact our Marketing Department

## LED DISPLAYS



c/w DIM-CG-100  
universal dimmer

Code	LED-DISPLAY1	LED-DISPLAY2	LED-DISPLAY3	LED-DISPLAY3-DIM
Size (mm)	370(W) x 284(H) x 120(D)	370(W) x 284(H) x 120(D)	400(W) x 400(H) x 125(D)	
Lamp Holders	5 x 230V Sockets	4 x 230V Sockets + 1 x 12VAC Socket	5 x 230V (E27) Sockets	
Description	This Display is for 230V AC/DC Dynamics CFL and LED Lamps only.	This Display is for 230V/12V AC/DC Dynamics CFL and LED Lamps only.	This Display is for 230V AC/DC Dynamics CFL and LED Lamps only.	

## LED SHELF LIGHT C/W GLASS

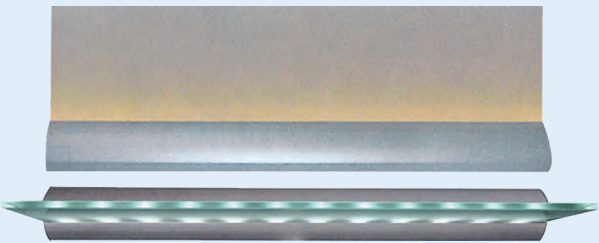

**Shelf with LED Edge Lighting** - 230VAC | Housing Material: Aluminium  
| Shelf Material: Glass

Code	Lamp	Size (mm)
EL201001-45-*	1.8W	450L x 180W x 60H
EL201001-60-*	2.5W	600L x 180W x 60H
EL201001-90-*	3W	900L x 180W x 60H

\*Add colour to code: ○ CW (Cool White), ● R (Red), ● GR (Green), ● BL (Blue), ● Y (Yellow)

## LED SHOWER HEADS

No battery required 100% water driven



Code	SHL003	SHL004	SHL005
Mode	Temperature Controlled	Temperature Controlled	Temperature Controlled
Features	Blue: Under 30°C, Pink: 31 - 40°C Red: 41 - 50°C, Red Flashing: Above 50°C	Blue: Under 30°C, Pink: 31 - 40°C Red: 41 - 50°C, Red Flashing: Above 50°C	Blue: Under 30°C, Pink: 31 - 40°C Red: 41 - 50°C, Red Flashing: Above 50°C
Size (mm)	Ø200 x 10	200 x 200 x 10	300 x 300 x 10

No battery required 100% water driven



Code	LEDSH-MC	LEDSH-RGB
Mode	Multi Colour	RGB Colour (Temperature Indicating)
Features	When water flows the LED will light up and colour will change gradually	When water flows the LED will light up, Green when temperature is ≤ 25°C, Blue when temperature is between 26°C - 35°C, Red when temperature is between 36°C - 45°C. Red will flash when temperature exceeds 46°C

## LED STAGE LIGHTS

For single colour, 2 channel DMX Strobe/Dimmer

**LED PAR 46 - 5 Channel DMX Controller**



**LED PAR 56 - 5 Channel DMX Controller**



**LED PAR 64 - 4 Channel DMX Controller**



**575W MultiFunction PAR64**



Code	LDP-005-*	LDP-006-*	LDP-007-*	LDP-008-*	AVL26
Size (mm)	190 x 190 x 330	210 x 210 x 310	230 x 230 x 320	230 x 230 x 400	430 x Ø265
LED's	94 x 0.16 (15W)	107 x 0.19 (20W)	177 x 0.17 (30W)	177 x 0.17 (30W)	-
IP Rating	<b>IP33</b>	<b>IP33</b>	<b>IP33</b>	<b>IP33</b>	<b>IP20</b>
Description	Long Can Control Mode: DMX, Stand Alone, Master & Slave, Sound Activated and Auto	Control Mode: DMX, Stand Alone, Master & Slave, Sound Activated and Auto	Short Can with Dip Switch DMX512 Signal, 4 Channels, including Auto, Strobe, Master-Slave and synchronously running	Long Can with Dip Switch	c/w 4 lenses (for different beam angles) and colour gel frame

\*Add colour to code: ● R (Red), ● BL (Blue), ● Y (Yellow), ● GN (Green), ○ CW (Cool White), ○ WW (Warm White)

**High Power LED PAR 64**



**High Power LED PAR 64**



**PAR 64 Empty Can**



**Lamp for PAR 64 Can**

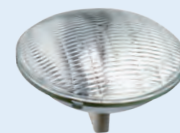

**Colour Gels for PAR 64**

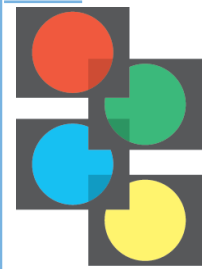

Code	LDP-011-*	LDP-012-*	LDP-015-*	RTL-19	PAR64-*	PARGEL-*
Size (mm)	230 x 230 x 360	230 x 230 x 360	305 x 305 x 340	255 x 226 x 445	Ø 8"	Sheet size: 100x80cm
LED's	36 x 1W(36W)	36 x 3W(108W)	36 x 1W(36W)	1000W	1000W (Halogen)	
IP Rating	<b>IP33</b>	<b>IP33</b>	<b>IP65</b>	<b>IP33</b>		
Description	6 DMX Channels. Aluminium PAR Can. Auto, Strobe, Master Slave, Synchronously Running		6 DMX Channels Digital Display Waterproof	Lamp to be Ordered Separately c/w Frame for Colour Gels	Colour Gels to Ordered Separately	Red, Green, Blue and Yellow Available

\*Add colour to code: ● R (Red), ● BL (Blue), ● Y (Yellow), ● GN (Green), ○ CW (Cool white), ○ WW (Warm White), ●●● RGB

\* Add type to code:  
MF (Medium Flood),  
WF (Wide Flood),  
NS (Narrow Spot)

\*Add colour to code:  
● R (Red), ● BL (Blue),  
● Y (Yellow),  
● GN (Green)

### Search Lights with Moving Head with DMX



Code	RTL47	RTL48	RTL54B
Size (mm)	880 x 790 x 1200	940 x 80 x 1250	810 x 620 x 730
Wattage	7kW	10kW	2.5kW
IP Rating	<b>IP54</b>	<b>IP54</b>	<b>IP54</b>
Supply V/A	230V/30.4A	230V/43.4A	230V/10.8A
Description	DMX	DMX	7 Channels. DMX. CMY

### Colour Changing City Light



Flight Cases included in all the above

**STAGE LIGHTS**

	<u>LED 4-eyes Whirlwind Light</u>	<u>3-Output Laser Effect LED</u>	<u>LED Flowing Light</u>
			
<b>Code</b>	<b>LDE-027</b>	<b>LDE-031</b>	<b>LDE-015</b>
<b>Size (mm)</b>	500 x 300 x 140mm	350 x 250 x 170mm	375 x 345 x 210mm
<b>LED's</b>	180 x Ø5 RGB (40W)	192 x Ø5 RGB (20W)	96 x Ø5mm (15W)
<b>Description</b>	11 DMX Channels, Master/Slave	Sound activated, Auto, 6 DMX channels	DMX512 signal, 4 channels including Auto, Strobe, Master/Slave, Synchronously running

	<u>LED Moving Head Effect Light</u>	<u>LED Vertigo</u>	<u>4 x 55W Soft Light</u>	<u>Firefly Laser</u>	<u>Crystal Ball LED</u>
					
<b>Code</b>	<b>LDE-019</b>	<b>LDE-033</b>	<b>AVL37</b>	<b>SML-011</b>	<b>LDE-103</b>
<b>Size (mm)</b>	220 x 170 x 290mm	410 x 280 x 280mm	635 x 290 x 110mm	285 x 100 x 135mm	Ø182 x 156mm
<b>LED's</b>	84 x 0.14 (12W)	224 x Ø5 (50W)	–	Green 532 nm: 100mW	3 x 4W
<b>Description</b>	DMX512 signal, 4 channels including Auto, Strobe, Master/Slave, Synchronously running	Sound activated, Auto, Master/ Slave	Fluorescent	DMX512, Sound activated, Auto	DMX512, channels sound activated, auto

	<u>Green Intelligent Laser with ILDA Interface</u>	<u>Firefly Laser Light with Colour Changing LED Wash</u>	<u>LED Super Mini Strobe Light</u>	<u>LED Waterproof Strobe Light</u>
				
<b>Code</b>	<b>AV-G100</b>	<b>SML-032</b>	<b>LDE-022</b>	<b>LDE-023</b>
<b>Size (mm)</b>	400 x 300 x 150mm	290 x 190 x 135mm	130 x 85 x 55mm	240 x 200 x 120mm
<b>LED's</b>	Green 532nm: 100mW	Laser: Green 60mW Red 100mW LEDs: 1x Red, 1x Green, 1x Blue 1W	24 x Ø5mm (5W)	116 x Ø10mm (20W)
<b>Description</b>	DMX512, Sound activated, Auto	8 DMX channels, Sound activated, Auto, master/ Slave	With speed adjustability	Strobe, Sound activated, both speed adjustable

\*Add colour to code: ● **R** (Red), ● **GN** (Green), ● **BL** (Blue), ● **Y** (Yellow), ○ **CW** (Cool White)

STAGE

LIGHTING





**LONGMEADOW**

26 Nguni Drive, Longmeadow  
Business Estate West, Edenvale  
Gauteng  
Tel: +27 10 202 3300  
Fax: +27 10 202 3365  
Email: info@acdc.co.za

**GERMISTON**

Sharland Street, Driehoek,  
Germiston, Gauteng  
Tel: +27 11 418 9600  
Fax: +27 11 418 9633  
Email: germiston@acdc.co.za

**CAPE TOWN**

Richmond Southern Close, Lenie  
Adams Avenue, Richmond Park  
Tel: +27 21 492 2000  
Fax: +27 87 807 5279  
Email: cape@acdc.co.za

**PINETOWN**

Unit 10, Pine Industrial Estate  
Pineside Road, New Germany  
Pinetown, Kwa-Zulu Natal  
Tel: +27 31 700 4215  
Fax: +27 31 700 4330  
Email: kzn@acdc.co.za

**RIVERHORSE**

6 Riverhorse Close Riverhorse  
Valley Business Estate,  
Durban, Kwa-Zulu Natal  
Tel: +27 31 492 4800  
Fax: +27 87 405 0775  
Email: rvh@acdc.co.za

FOLLOW US ON SOCIAL MEDIA



AC/DC SFC LIT 1021



2nd Edition July 2022

Specifications are subject to change from time to time,  
without notification in this publication.

© ACDC Dynamics 2022

THINK ELECTRICAL